

OP-XY full guide
1.0.9

1	hardware overview	1
1.1	power on and charging	2
1.2	speaker, volume and pitchbend	2
1.3	inputs and outputs, internal mic and level meter	3
1.4	technical specifications	3
1.5	electrical characteristics	3
2	layout	4
2.1	main modes	4
2.2	modules	4
2.3	tracks	5
2.4	sequencer	5
2.5	transport controls	5
2.6	keyboard	6
2.7	sample	6
2.8	projects	6
2.9	tempo	7
2.10	com	7
2.11	players	7
2.12	bar	8
2.13	volume	8
2.14	encoders	8
3	guide conventions	9
4.	get started making your first project on OP–XY	10
4.1	sequencing a drum beat	11
4.2	recording a bassline	3
4.3	adding chords	14
4.4	adding punch-in FX™	15
5.	main modes and modules	16
5.1	main modes	17
5.2	modules	18
6.	track buttons	19
6.1	using the track buttons	20
6.2	linking tracks	20
7.	sequencer	21
7.1	step sequencing	22
7.2	live recording	23
7.3	step recording	24
7.4	extending your sequence with bar	25
		26
8.	step components	
8.1	what are step components?	27
8.2	adding step components to a sequence	28
8.3	what step components are there?	29
8.4	step component reference table	30
9.	players	31
9.1	arpeggio	32
9.2	maestro	32
9.3	hold	33
10.	project	34
10.1	rename, save, create and configure	35
10.2	projects folder	35
10.3	project settings	36

11.	tempo	37
11.1	edit tempo	38
11.2	what are grooves?	39
12.	workflow	40
12.1	patterns, scenes, songs and projects	40
12.2	creating a song	40
12.3	the importance of saving	40
14.	instrument	41
14.1	engine	41
14.2	envelopes	42
14.3	filter	43
14.4	lfo	44
14.5	preset settings	49
14.6	view and create presets	50
15.	auxiliary	51
15.1	brain	52
15.2	punch-in FX™	53
15.3	external midi	54
15.4	external cv	56
15.5	external audio	57
15.6	tape	59
15.7	FX I and FX II	61
16.	arrange	63
16.1	switching tracks and patterns	64
16.2	edit controls	64
16.3	scenes and song mode	65
17.	mix	66
17.1	levels pans and sends	67
17.2	eq	68
17.3	saturator	69
17.4	master	70
17.5	signal flow diagram	71
18.	sample	72
18.1	one shot synth sampler	74
18.2	drum sampler	76
18.3	multisampler	78
18.4	sample folder	80
19.	com	81
19.1	setting the multi-out port and bluetooth midi	82
19.2	system settings	83
19.3	midi controller mode	84
19.4	devices	85
19.5	mtp	86
20.	synth engines	87
20.1	axis	88
20.2	dissolve	89
20.3	epiano	90
20.4	external	91
20.5	hardsync	92
20.6	organ	93
20.7	prism	94
20.8	simple	95
20.9	wavetable	96

21.	fx	97
21.1	chorus	98
21.2	delay	99
21.3	distortion	100
21.4	lofi	101
21.5	phaser	102
21.6	reverb	103
22.	how to	104
22.1	enable velocity	105
22.2	control a synth with midi	106
22.3	control an analog synth with cv and gate	107
22.4	sync a vintage drum machine	108
22.5	sync a pocket operator	109
22.6	send audio to and from an external effect	110
22.7	control OP–XY with a midi keyboard	111
22.8	use an audio interface with OP–XY	112
22.9	use the pitchbend as a modulation source	113
22.10	backup projects	114
22.11	load samples from a computer into the sample folder on OP–XY	115
22.12	write a song fast, with the brain	116
23.	midi cc reference table	117
24.	te boot	118
24.1	firmware update	119
24.2	factory reset	120
24.3	function test	121
24.4	reset volume potentiometer calibration	122
24.5	exiting te boot	123
25.	credits	124

1. hardware overview

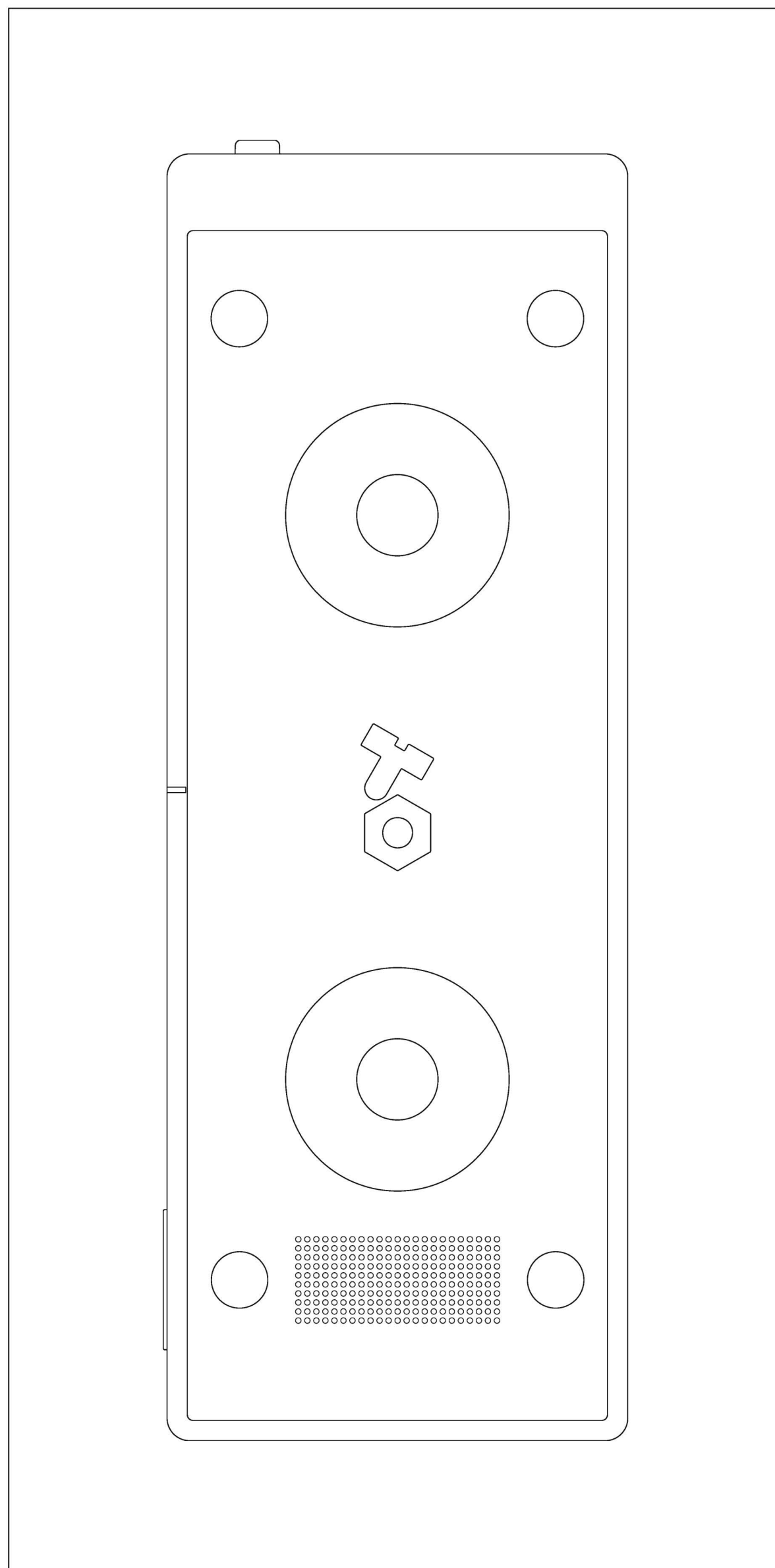
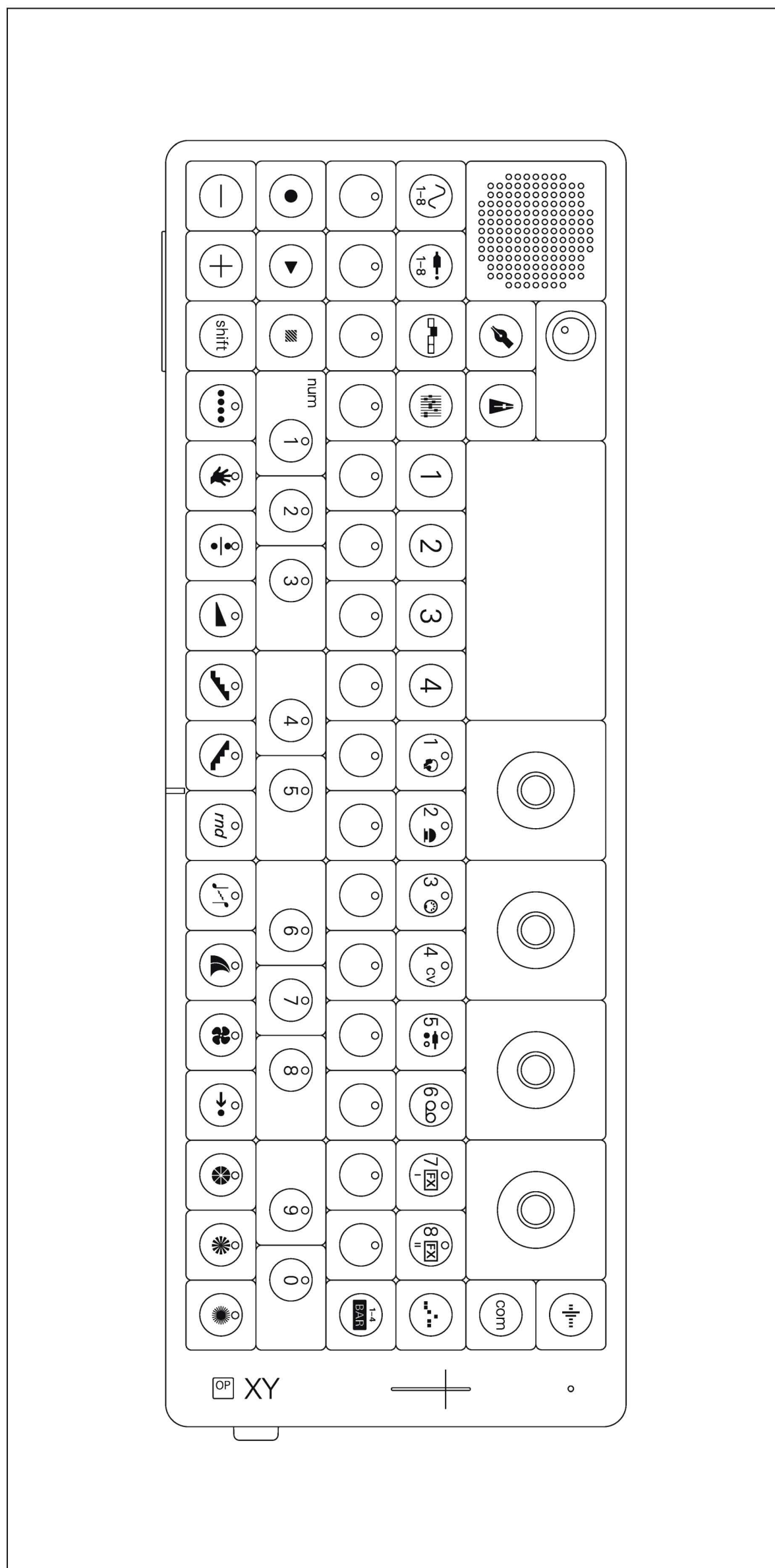

OP-XY is a precision tool, made in black anodized aluminium, with encoders in a fading gray scale of dark gray, mid gray, light gray and white. the backlit low profile keyboard is tactile, durable and responsive.

the display is a custom made color lcd, mounted directly onto the keyboard. the soft velcro rings on the bottom side mean the unit can be safely attached to a surface, case or stand.

highlights

- 64-step sequencer
- 24-voice polyphony
- 1920 PPQN
- parameter locks
- step components
- stereo signal path
- midi over bluetooth ble
- powerful sequencer workflow
- 16 programmable tracks
- unique synth engines
- built-in effects
- drum and synth sampler
- usb audio/midi host and device

1.1 power on and charging

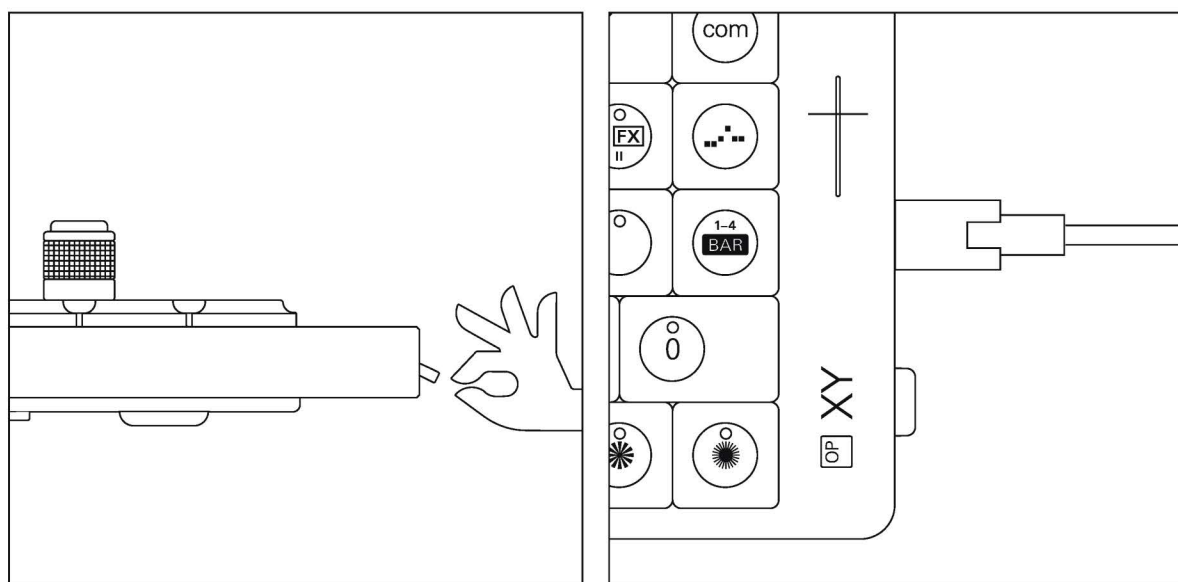

to power on your unit, flip the power switch located on the right side of the device to the up position. the display will show the logo and the current installed firmware version, you then arrive at the last selected track. to power off, flip the switch to the down position. the current state is stored automatically in the workspace. the next time you power on your OP-XY, everything will still be there, exactly as you left it.

OP-XY is charged through the usb-c port located on the right side of the unit. the first thing you should do is connect it to a computer or a usb charger. keep it connected until the battery is fully charged, indicated by the level meter. to check battery go to system settings. to keep the battery healthy, the unit should be charged at least every 6 months.

1.2 speaker, volume and pitchbend

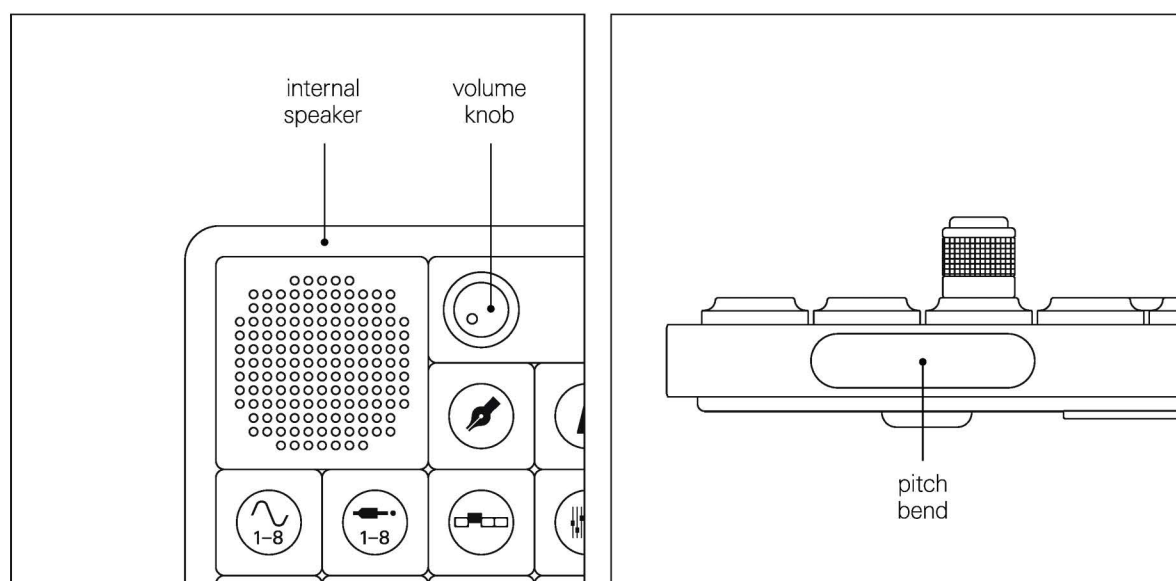

on the top right you can find the built-in microphone and the level meter.

on the bottom left side of the device you will find the pitchbend. it is pressure sensitive and will bend down when pressed on the left side or up on the right.

1.3 inputs and outputs, internal mic and level meter

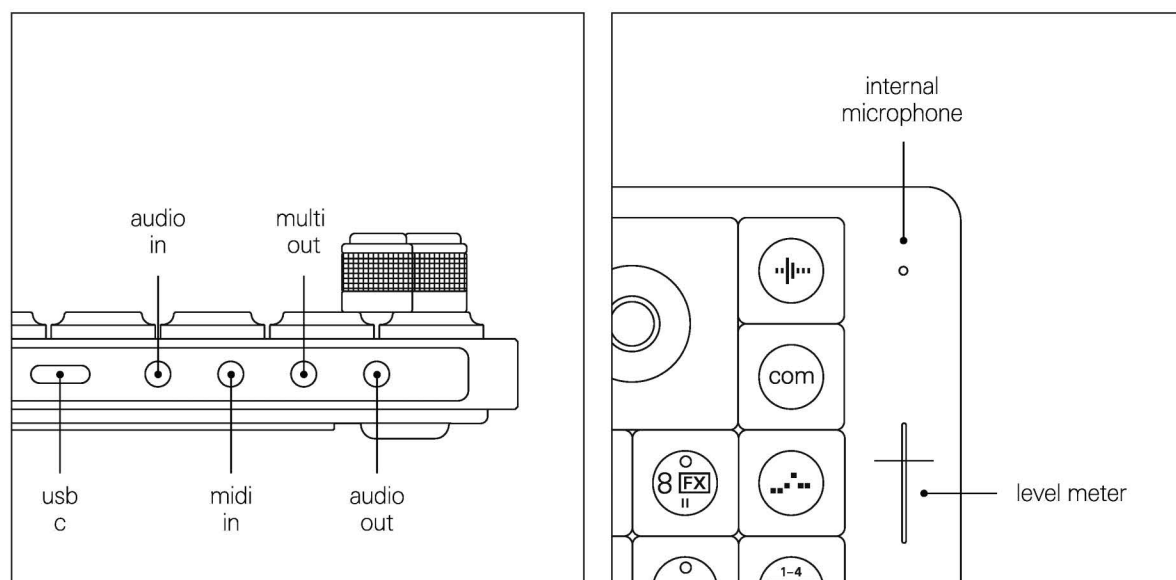

on the right side of the OP-XY you will find the 3.5 mm audio output jack, used to connect headphones or speakers. next, the multi out.

the multi out jack allows you to switch between six output options. these include midi, cv + gate, sync8, sync16, sync24 and audio.

then midi in, to control your OP-XY with other midi devices, followed by the 3.5 mm audio input jack to record line level audio straight into OP-XY.

the top left holds the internal speaker and the main volume knob.

1.4 technical specifications

- 3.5 mm stereo line-out with headset mic support
- 3.5 mm multi-out
- 3.5 mm midi in
- 3.5 mm stereo line-in
- usb type-c audio/midi host & device
- midi over bluetooth le
- 16-hour rechargeable battery
- 480 x 220 IPS TFT display
- 8 GB user storage

1.5 electrical characteristics

audio output:

level: 8 dBu, 2 Vrms
snr: 124 dBA

audio input:

level: 8 dBu, 2 Vrms
snr : 98 dBA
impedance: 13 kOhm
analog gain: 0-31 dB

multi output:

audio output level: 2 dBu, 1 Vrms
cv range: ± 5 V
sync/gate level: 5.2 V

2. layout

the core workflow of OP–XY is based around step sequencing, a way of working. you sequence tracks, one by one, to build the layers of a song. the four main modes: instrument, auxiliary, arrange and mix are where you'll spend the most time. press instrument to access the drum and synth tracks.

beneath the encoders you will find the 8 track buttons, press these to select which track to edit. press a note and following this, press a button on the step sequencer. keep layering and arranging as you like and press mixer to adjust track levels and eq of your mix. it's as simple as that to build your songs on OP–XY.

2.1 main modes

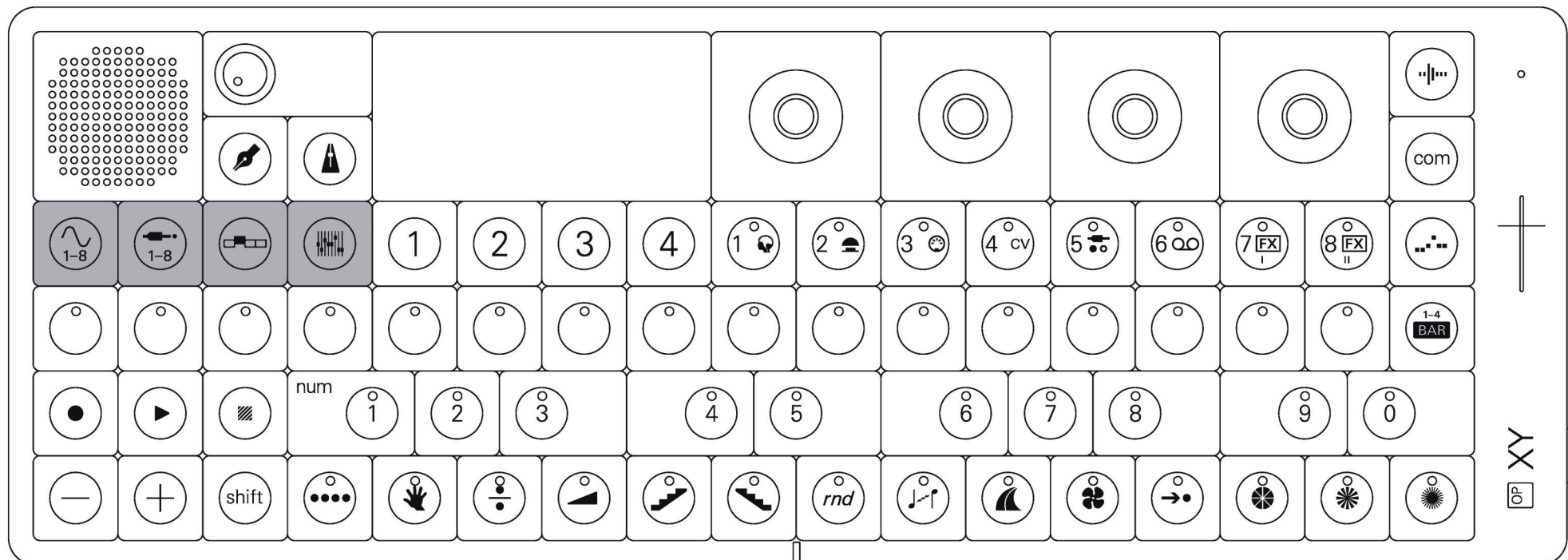

OP–XY features four main modes; instrument, auxiliary, arrange and mix. the modes are where you compose, transpose, build and mix your song.

2.2 modules

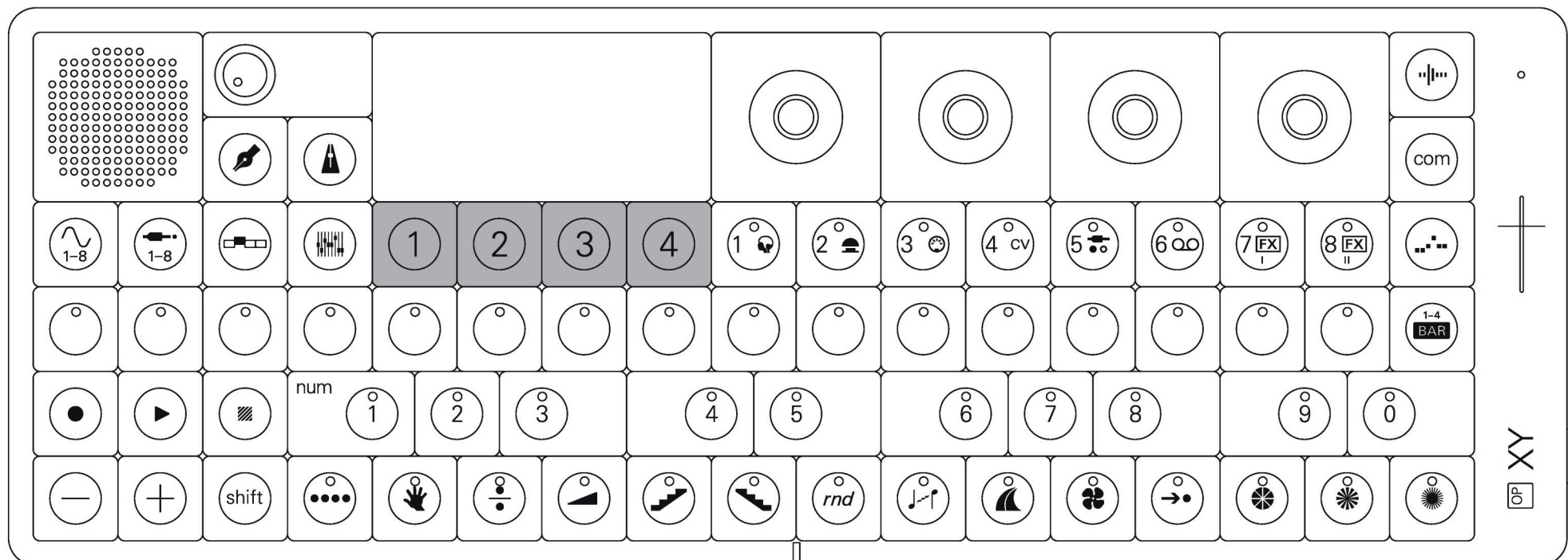

each main mode with the exception of arrange features four sub modes called modules. these allow you to edit the various parameters within the selected track using the four encoders.

switch between the available modules using the four buttons underneath the screen. in some instances a screen may have extra parameters that can be accessed by holding shift.

2.3 tracks

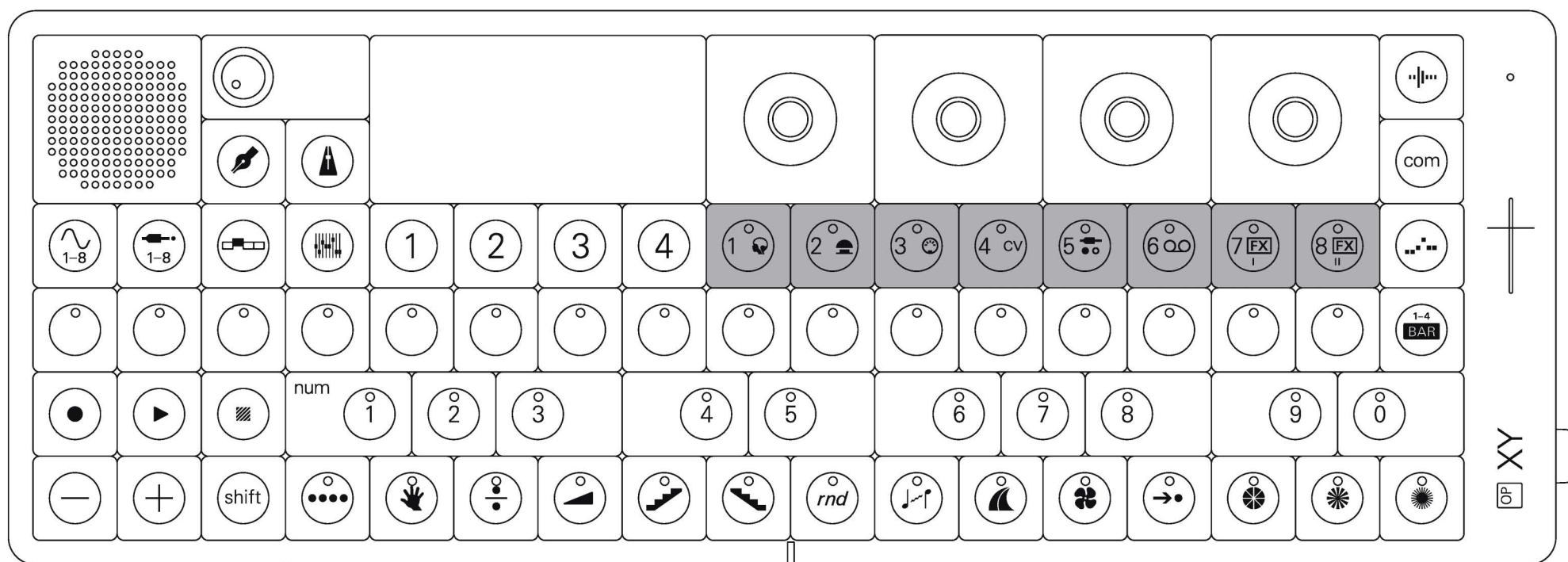

labelled 1-8, the track buttons allow you to control and edit the 8 instrument and 8 auxiliary tracks.

press a track button to enter that track. peep a white or red light? that's the current, selected track.

2.4 sequencer

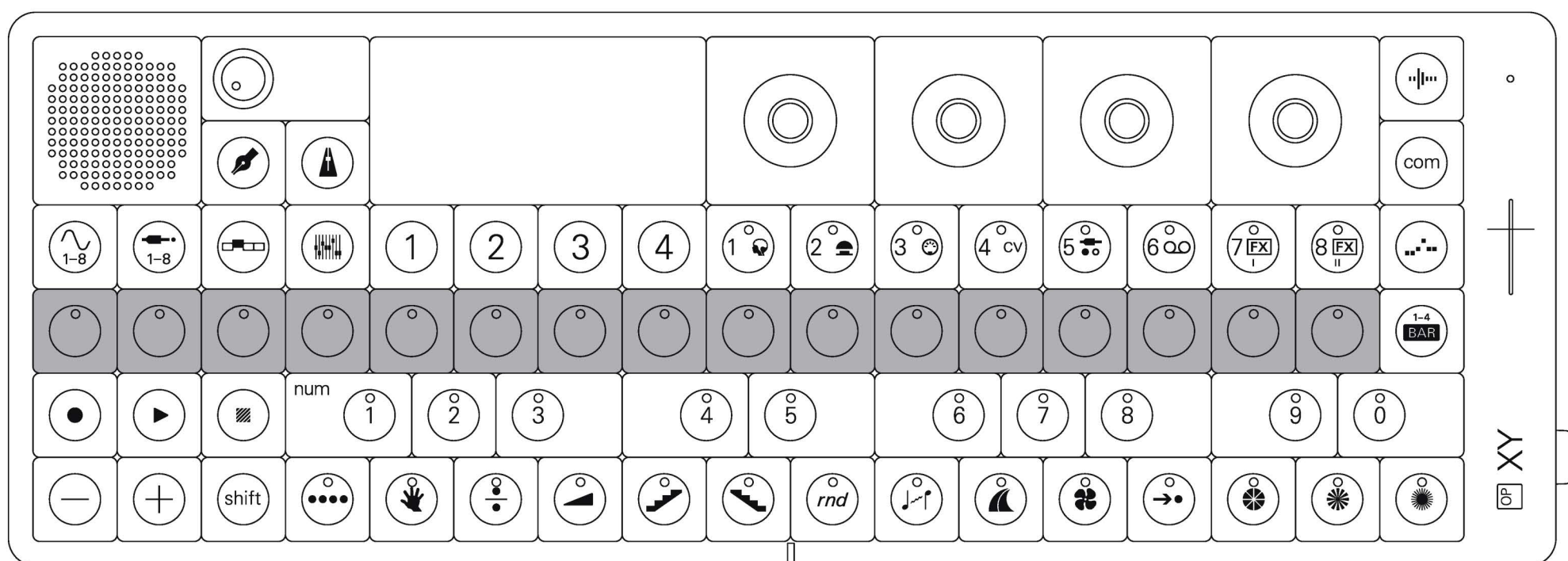

running across the middle of OP-XY is the step sequencer. this is the heart of the device.

it is where you can program a sound into the musical grid and is the launchpad for creating music within OP-XY.

2.5 transport controls

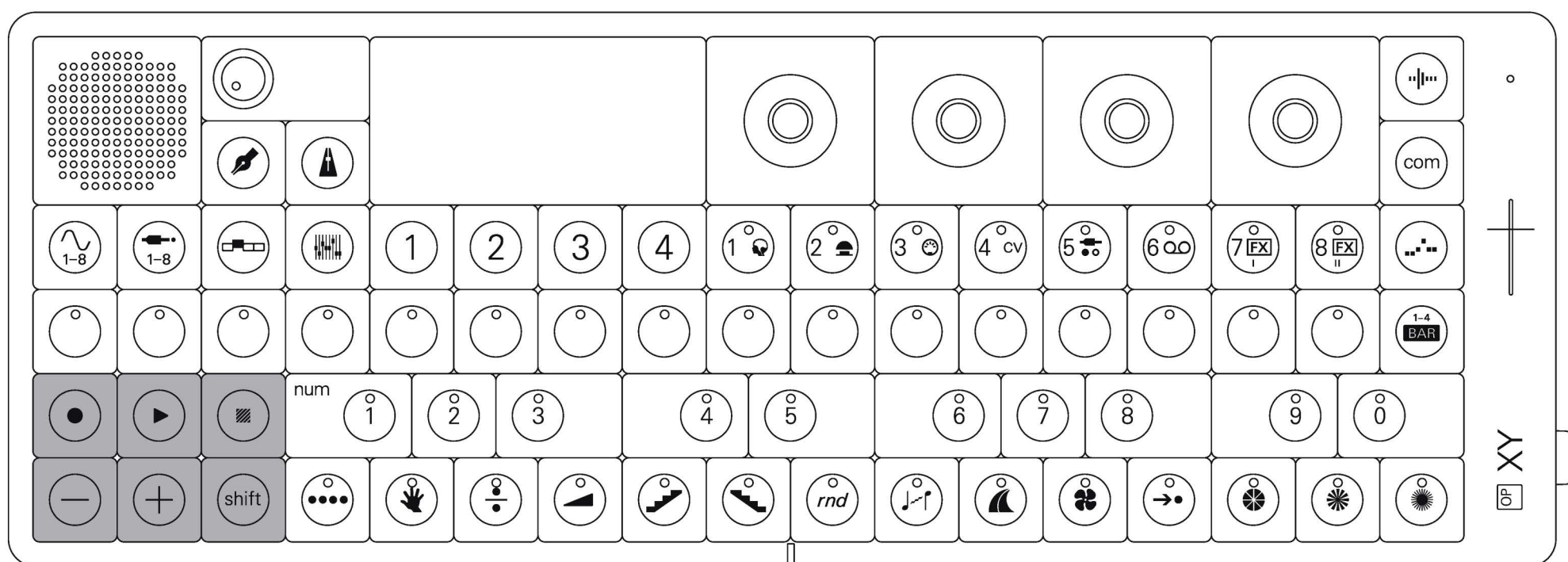

on the bottom left corner of OP-XY you can find the transport controls.

this is where you control record, play, stop, change octaves and access shift functions.

2.6 keyboard

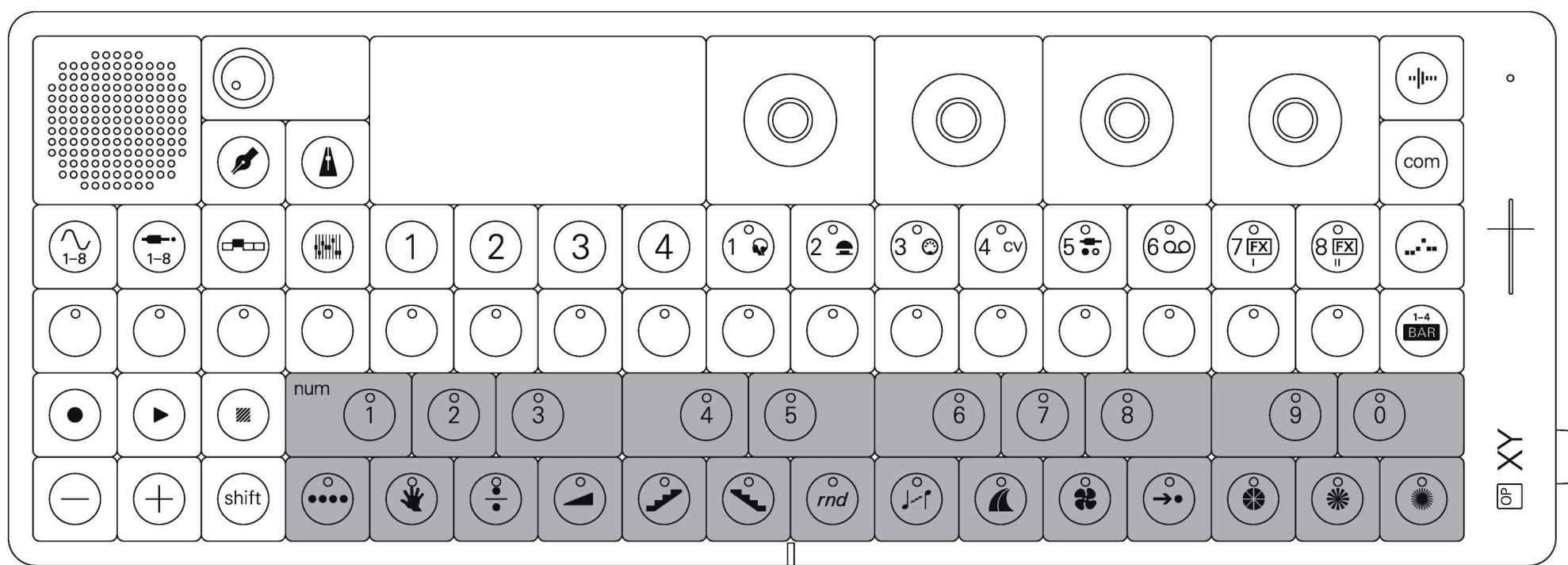

OP-XY features a two octave keyboard, perfect for playing, composing and sequencing. beneath the sequencer, and to the right of the transport buttons, you will find the keyboard.

within the OP-XY and throughout this manual sharps (black keys) are referred to as accidentals and non-sharps (white keys) as naturals. this is to prevent confusion with the color of the buttons all being the same.

2.7 sample

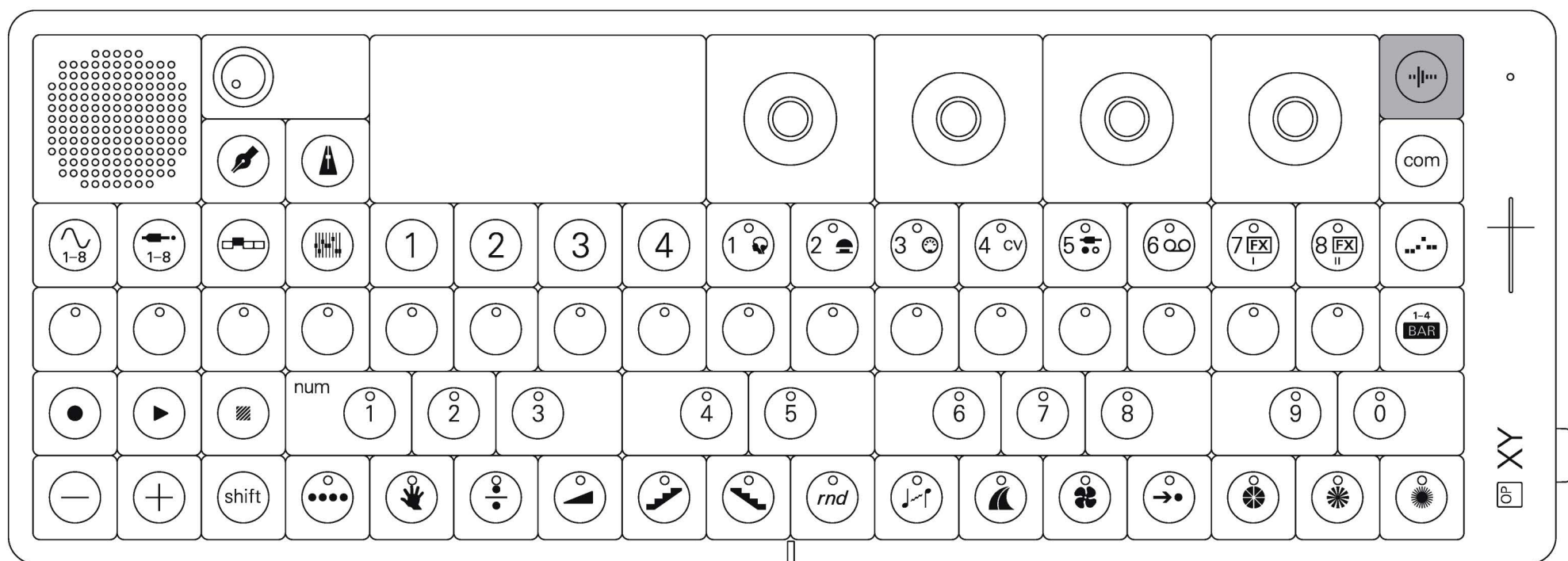

in the top right corner of the device you will find the sample button.

sampling is a fantastic way of introducing new sounds to your OP-XY and composing with them. you can sample from any input, including the built-in microphone.

2.8 projects

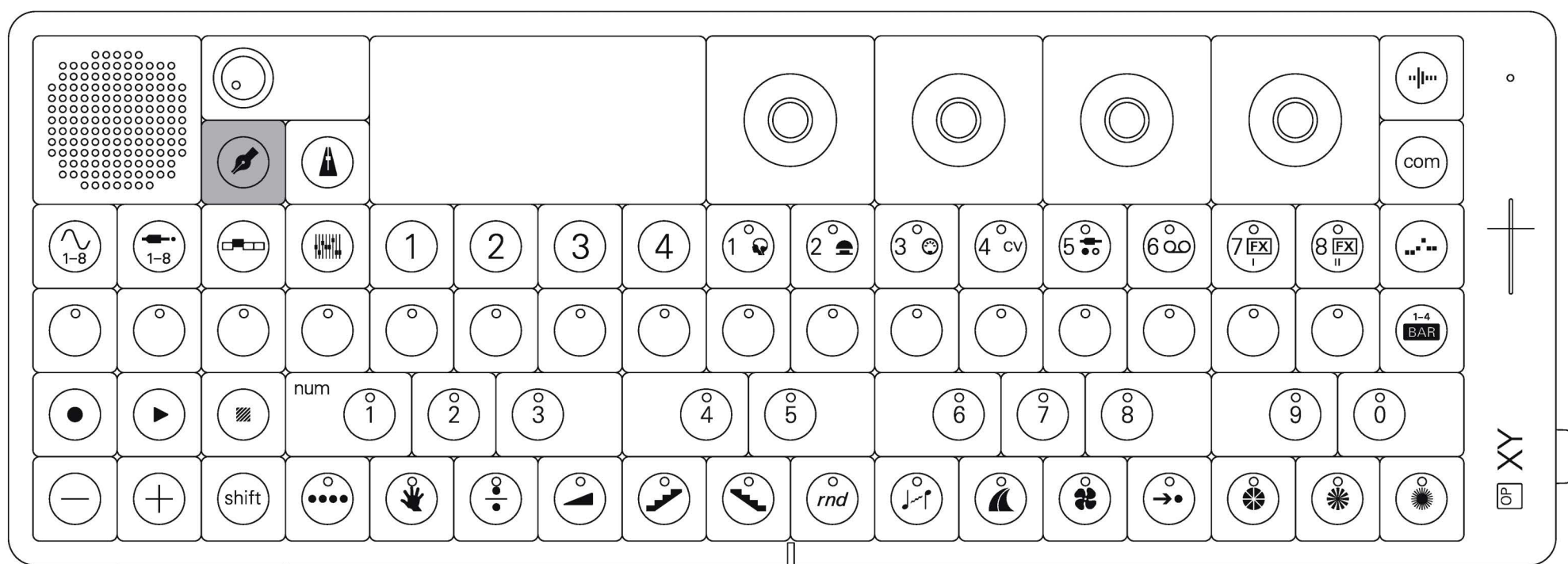

OP-XY can store thousands of projects.

press the projects button to edit and create projects.

2.9 tempo

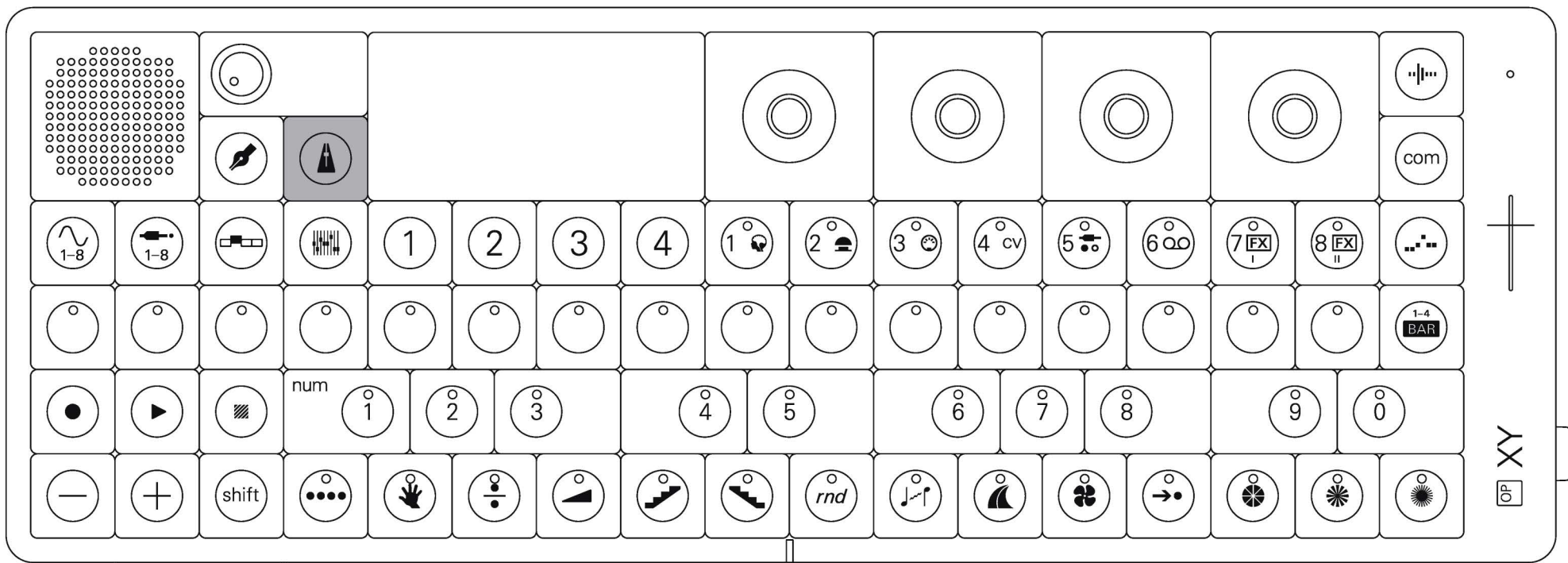

next to projects you will find tempo.

use tempo to speed up or slow down your song, add swing and turn the metronome on or off.

2.10 com

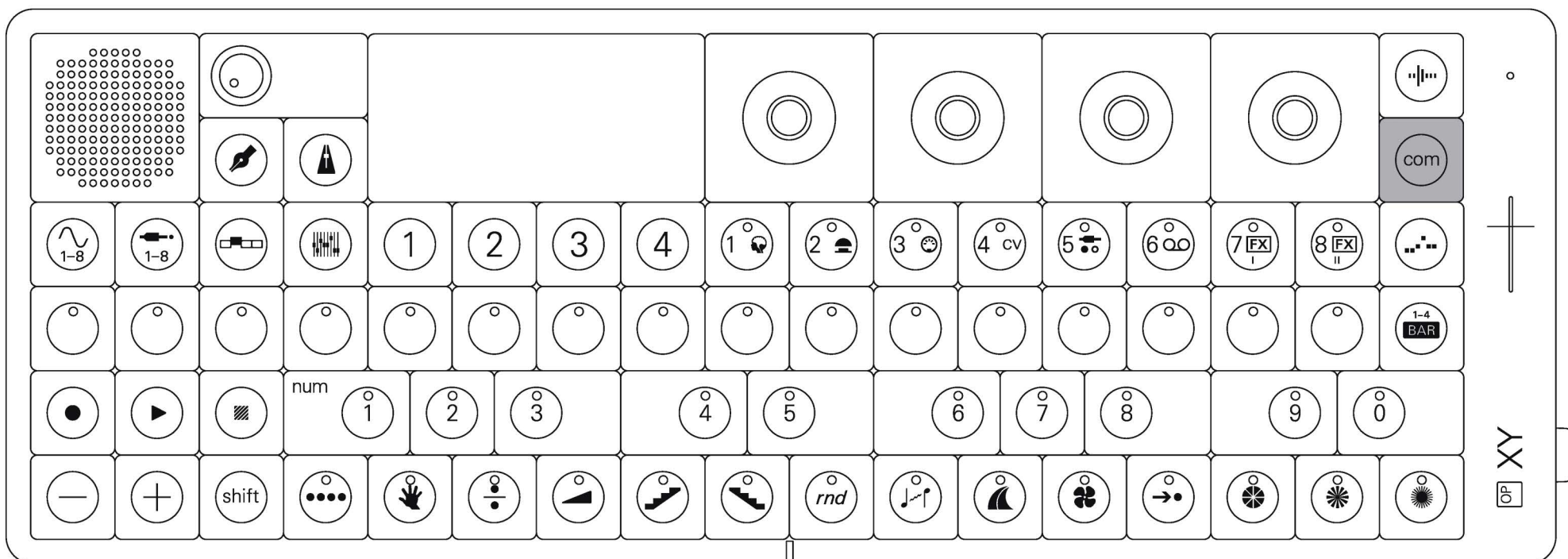

to the far right under sample you will find com.

com is where you control system settings, connect to other devices (wireless or wired) and select your outputs.

2.11 players

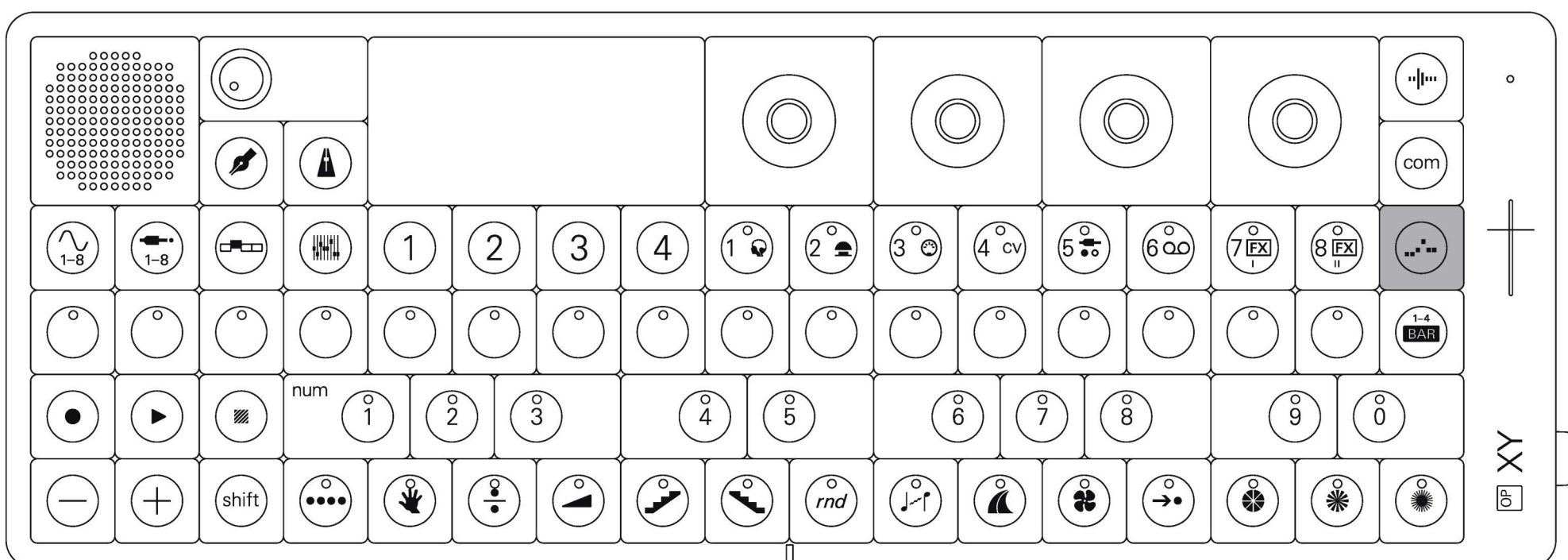

under com you can find players.

players use the notes in your sequence to trigger creative note effects such as arpeggios and chords.

2.12 bar

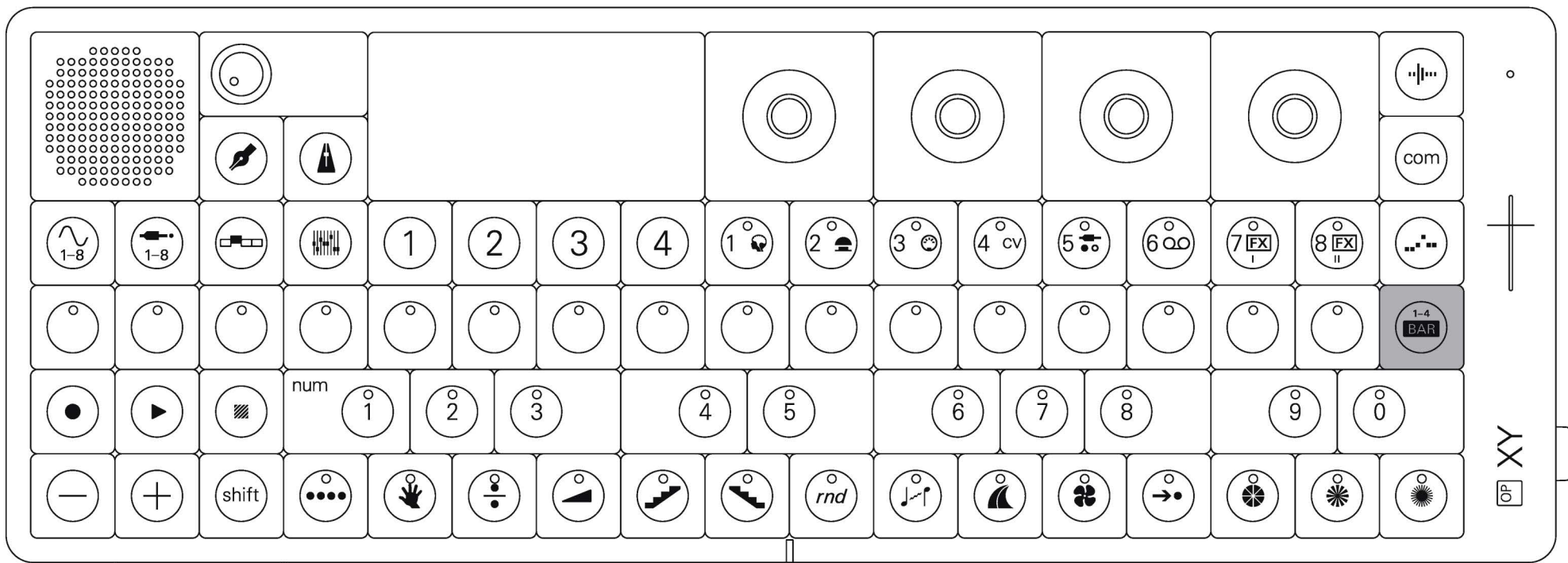

to the far right of the sequencer and below players is bar. bar allows you to extend your sequence and change sequence parameters such as quantisation.

2.13 volume

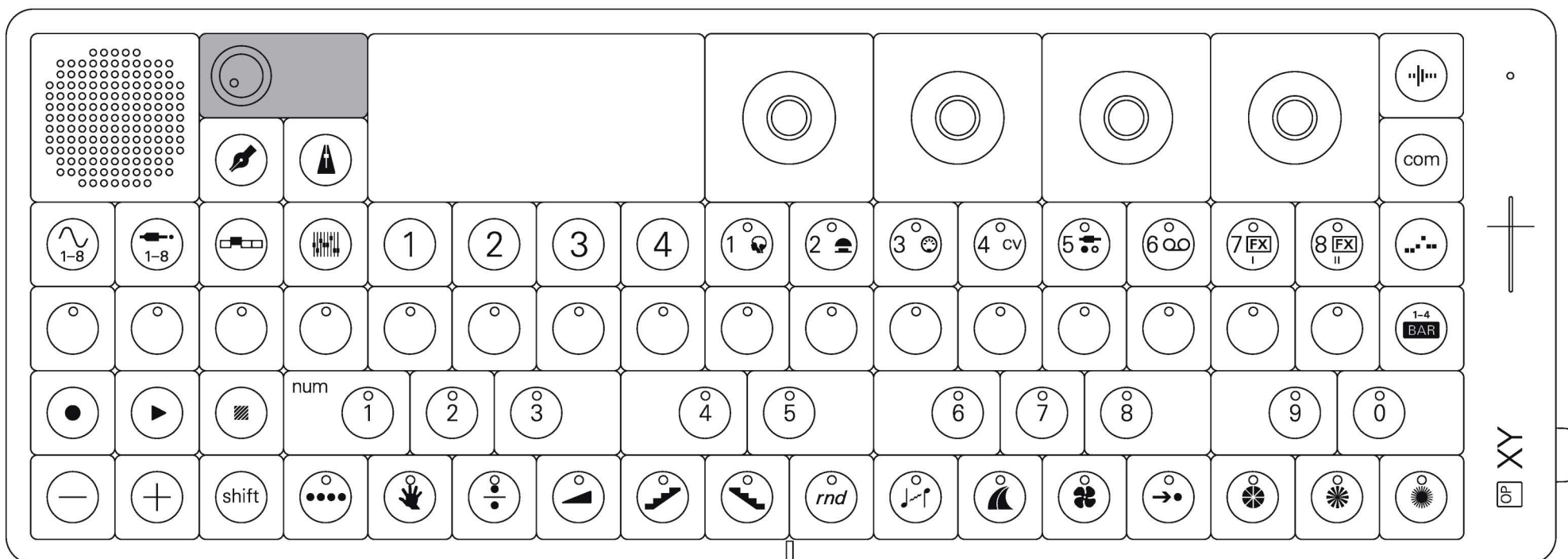

in the top left, beside the speaker is the volume control. rotate it to adjust the sound to your liking.

2.14 encoders

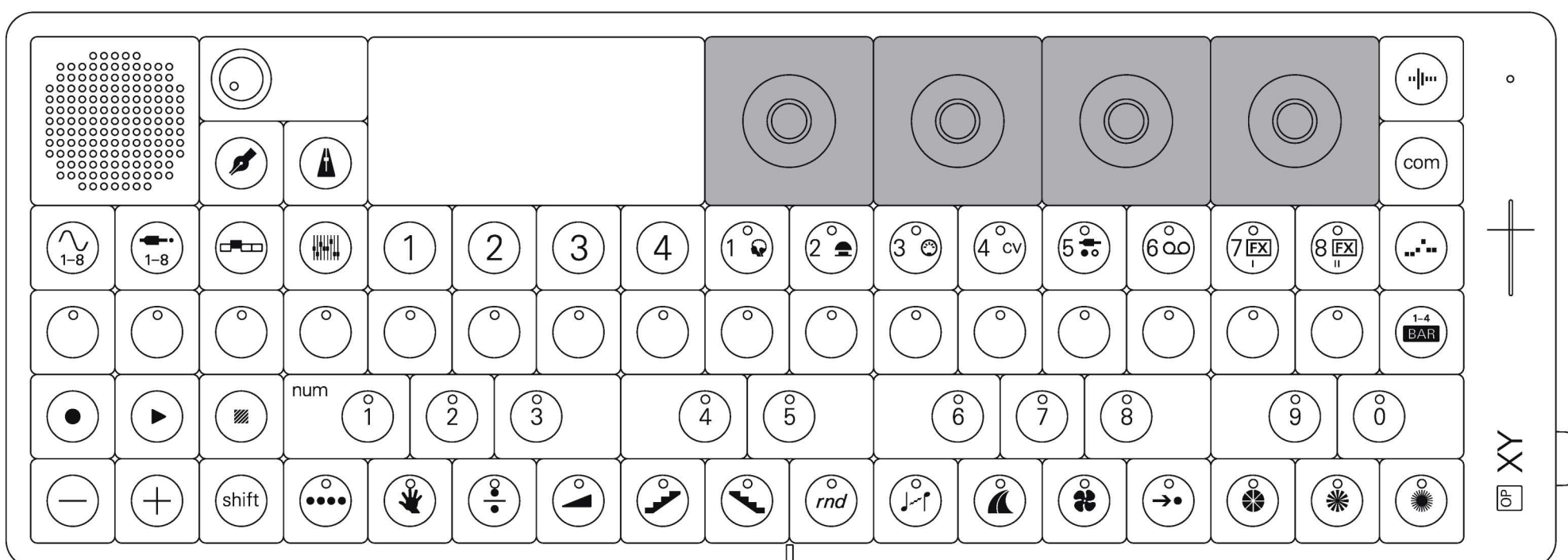

above the track buttons are the four encoders.

the encoders are colored dark gray, mid gray, light gray and white. use them to adjust parameters throughout the device.

3. guide conventions

throughout this guide we will follow some conventions, allowing you to better understand the buttons, combos and presses.

below you can find an index of these conventions for your reference.

single press

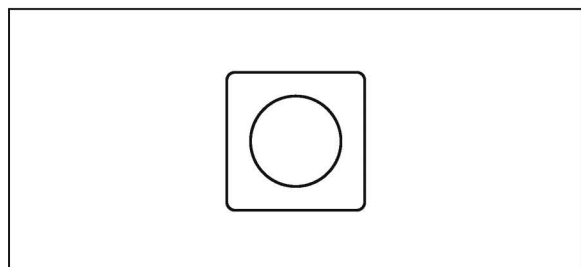

press and release one key at the time.

combo press

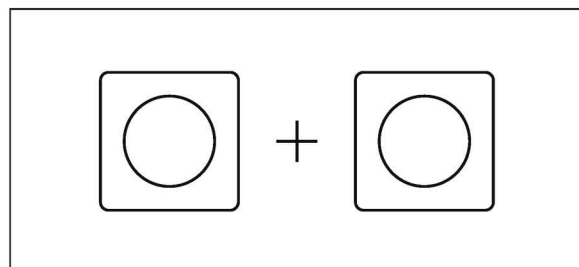

hold one key and press the second key.

sequence press

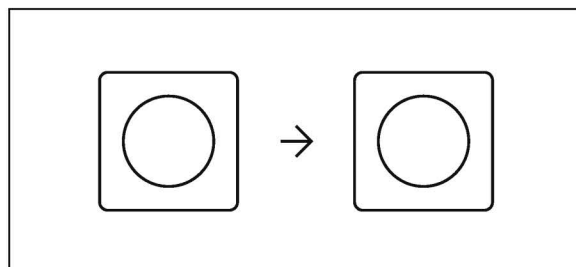

press one key, then another.

hold button

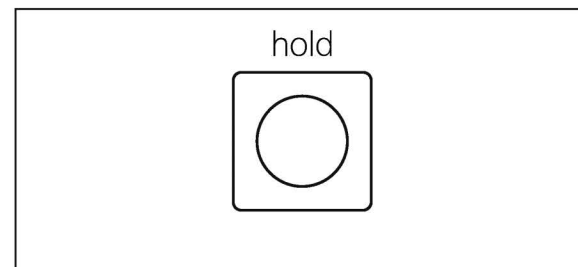

press and hold a button.

rotate encoder

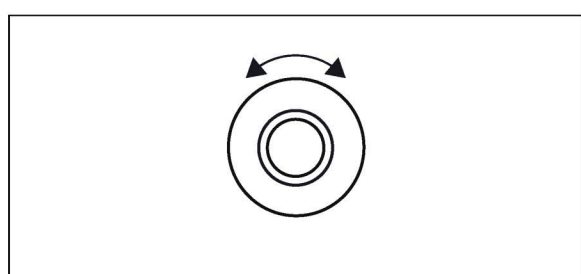

rotate the encoder.

click encoder

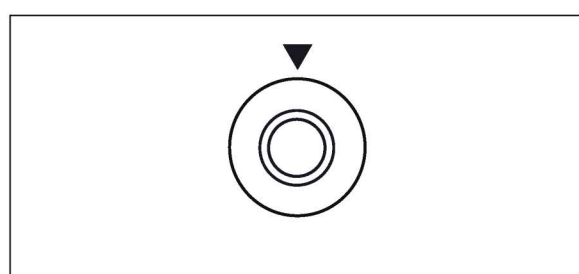

click the encoder.

press + rotate

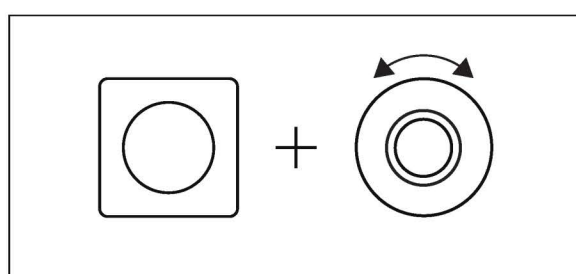

press the button and rotate the encoder.

hold + rotate

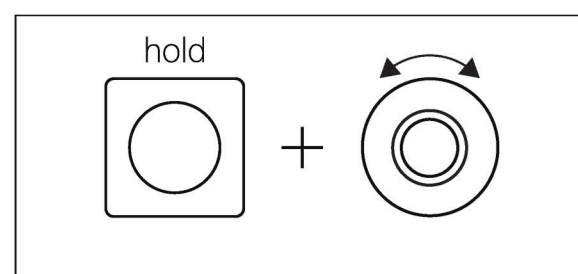

press and hold the button and rotate the encoder.

all encoders

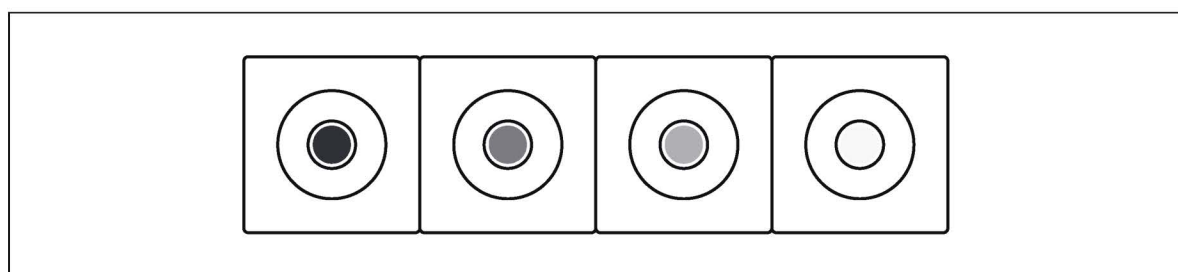

whole keyboard

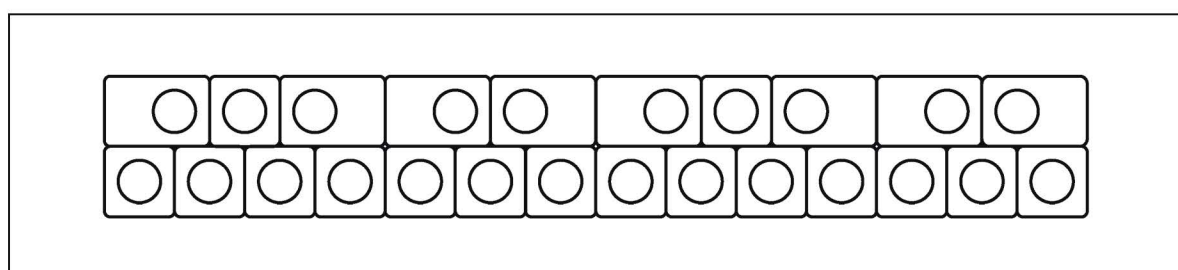

in some instances we may show the whole, this is to provide context for a series of buttons, rather than prompting you to play the keyboard itself

keyboard

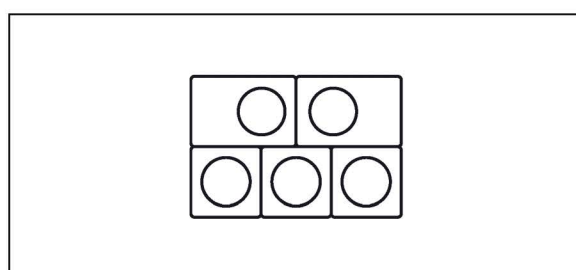

play notes on the keyboard.

chord

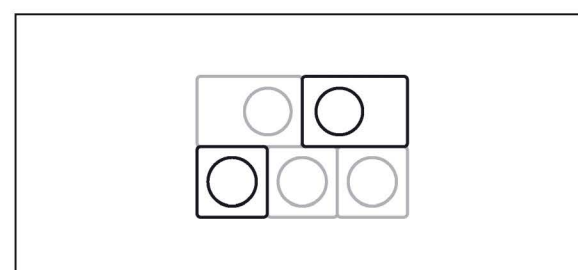

play multiple notes on the musical keyboard to make a chord.

sequencer buttons

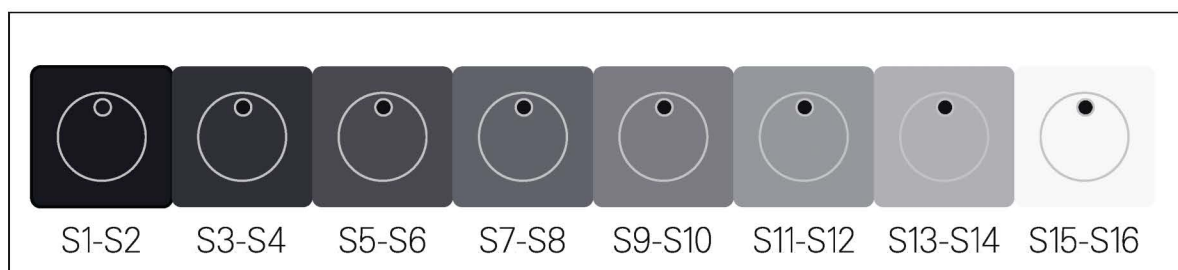

there are 16, 2 in each color of the greyscale. the buttons are displayed throughout the guide, providing context, when needed.

lit button

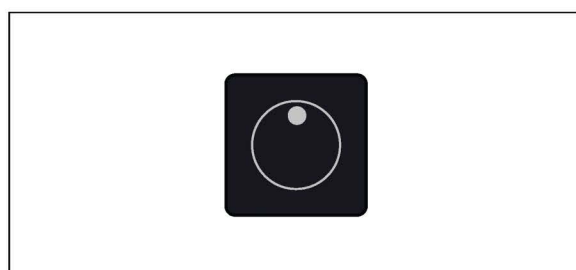

button is lit up and activated.

generic button

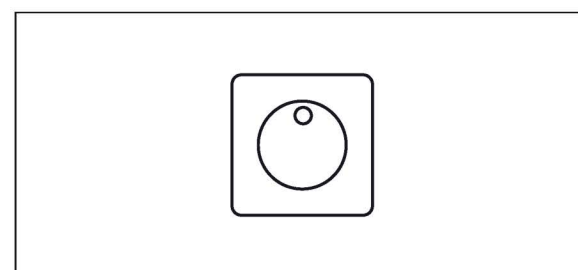

press any sequencer between S1-S16 button of your liking.

4. get started making your first project on OP-XY

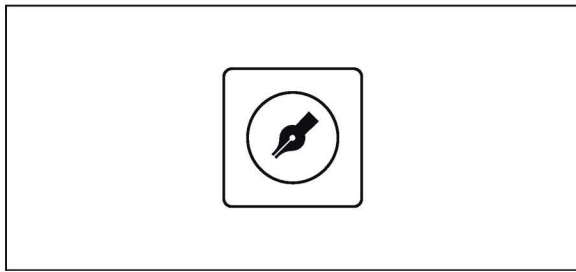

to get started making a song, first create a new project.

press project to open the project view.

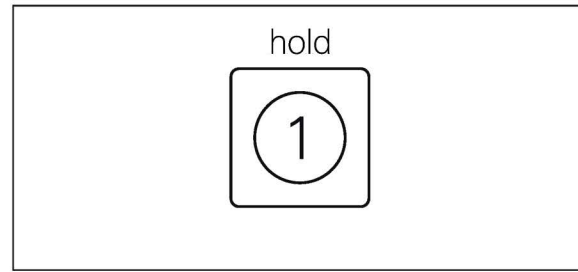

once in the project view, press and hold M1 to create a new project.

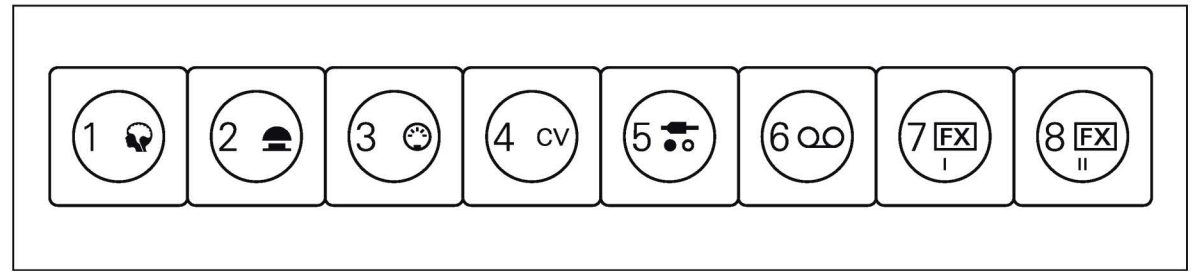

by default, instrument tracks 1 and 2 will have drums, 3 will have a bass, 4 a pluck, 5 a lead, 6 a soft pluck, 7 some strings and 8 a pad.

4.1 sequencing a drum beat

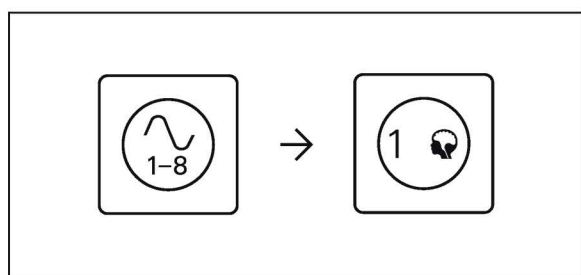

lets start by sequencing some drums. press instrument to make sure you are in instrument mode, then select track 1.

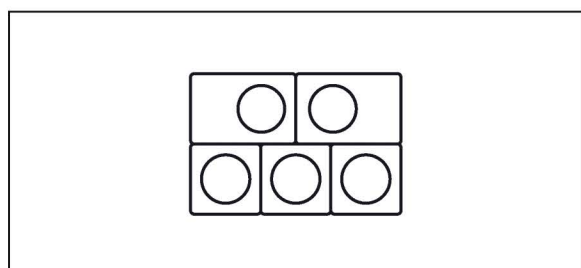

the musical keyboard will now have 24 different drum sounds. one on each key.

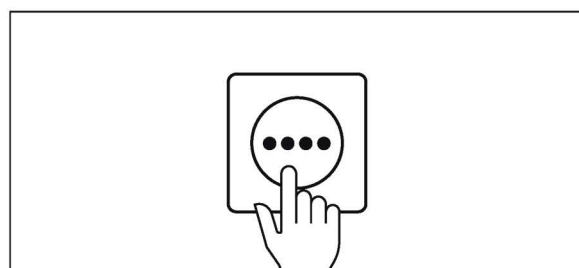

press the lowest 'f' key to select and start sequencing the kick drum. OP-XY will always remember the last pressed key.

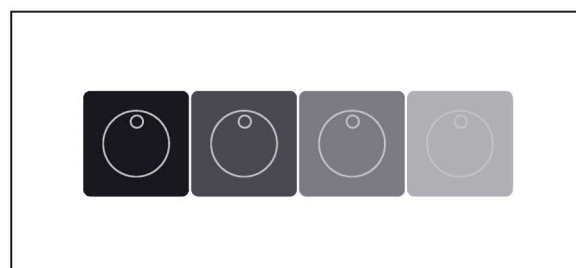

press the first, fifth, ninth and thirteenth sequencer buttons to record a four on the floor sequence with the kick drum.

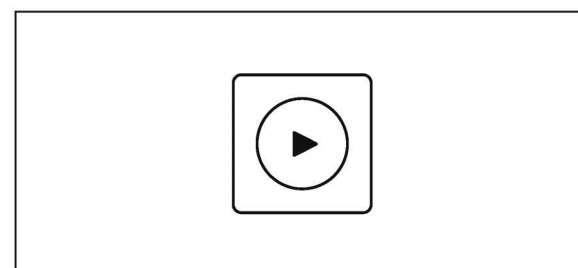

now press play to hear what you have just sequenced. press stop when you have heard enough.

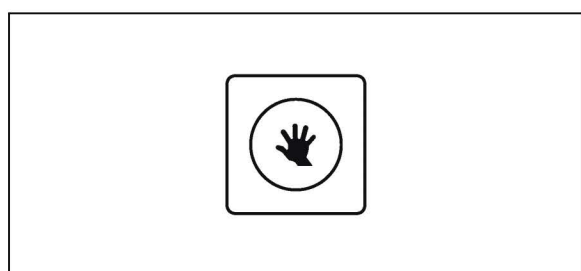

press the 'g' key adjacent to the kick drum to select a snare.

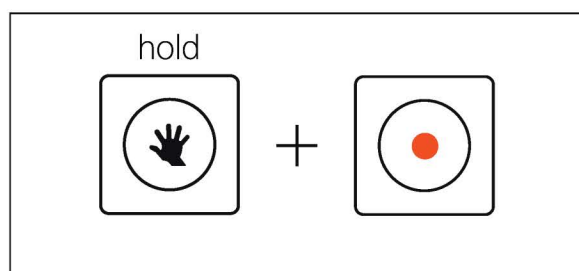

we are going to place it on the fifth and thirteenth step, but as you have a kick drum already recorded to those steps hold the snare drum key down and press the record button. this will show you only the steps with the snare drum recorded, which are none so you should see an empty sequence.

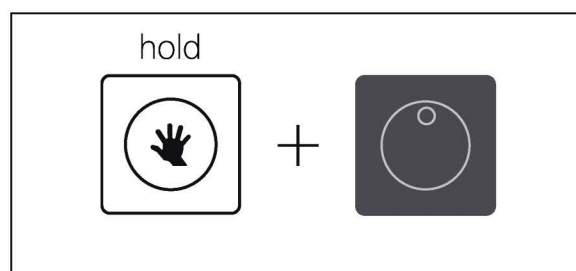

while continuing to hold down the snare drum press on the fifth and thirteenth steps. this will form a backbeat. let go when you are done.

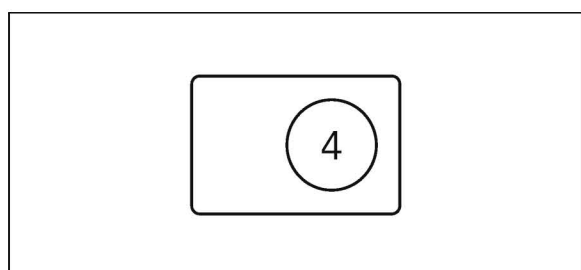
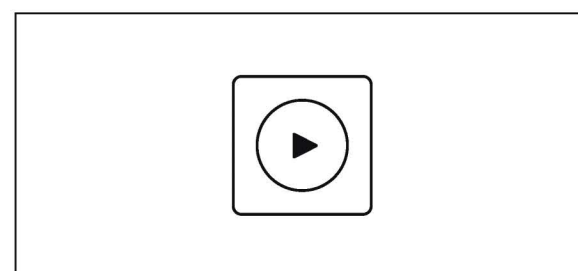

now lets add a hi-hat. press the 'c#' key to hear and select a hi-hat.

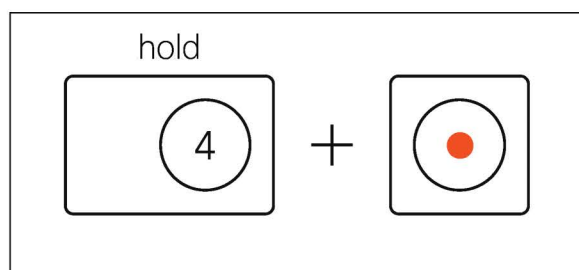

once again, as we have our kick and snare recorded but only want to view the hi-hat pattern, hold down the hi-hat key and then press record to view only it's sequence.

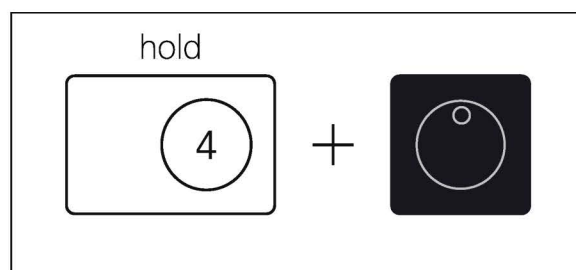

while continuing to hold down the hi-hat press every other step. let go when you are done.

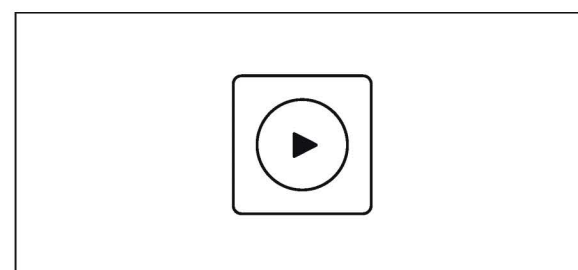

now press play to hear the kick, snare and hi-hat pattern.

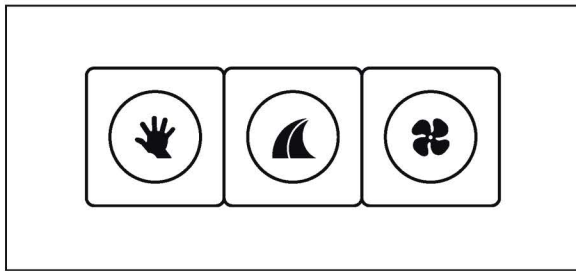

now that we have a simple drum beat, let's spice it up with some step components.

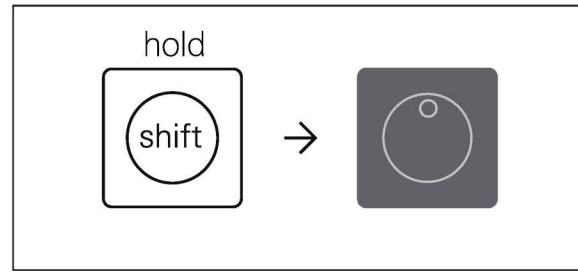

press and hold the shift then press the seventh step (which should now be lit up, as the hi-hat has been recorded to it).

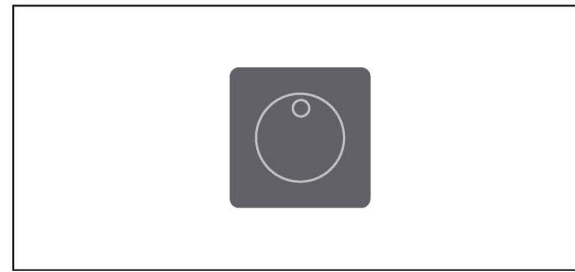

it will start to blink, letting you know that it has been selected.

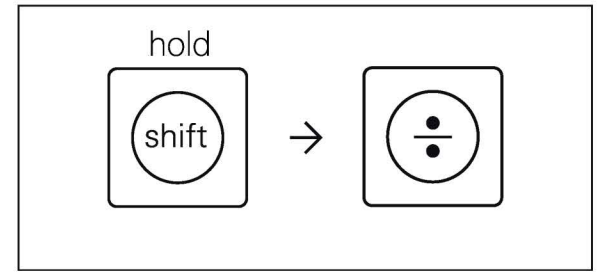

continue to hold shift and then press the lowest 'a' key. this is the natural key that represents the multiply step component. you should see a text box on the screen with the name multiply. multiply will take a step and divide it into multiple shorter steps, creating a ratchet effect.

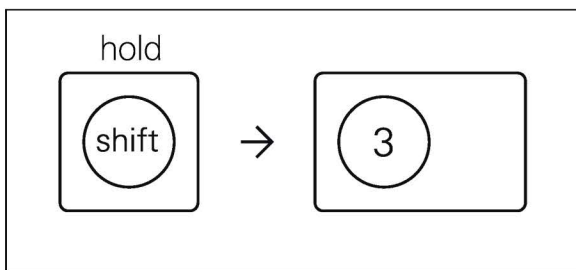

continue to hold shift then press the accidental key labelled '3' (a#). this will change the text on screen to say "divide into 3 trigs" meaning that the one hi-hat step will be split into three shorter ones.

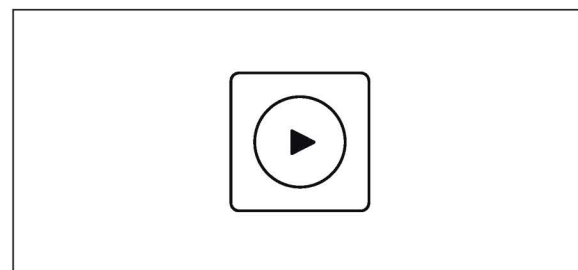

now you can finally let go of shift and press play to hear your finished drum beat.

4.2 recording a bassline

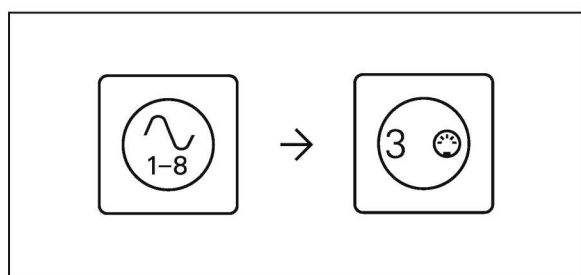

now lets add a bassline.
press instrument to make
sure you are in instrument
mode, then select track 3.

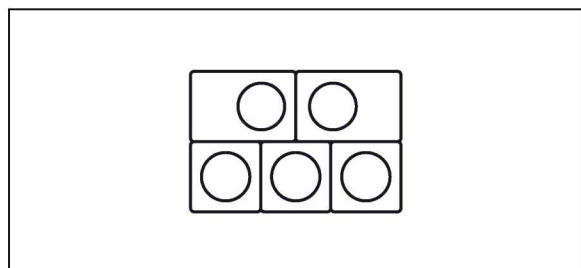

the musical keyboard will
now play the 24 different
notes.

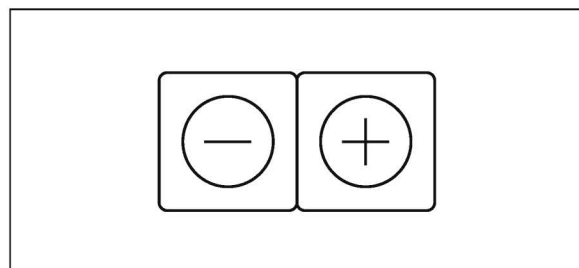

try playing some notes on
the keyboard. you can use
the (-) and (+) buttons to
change octaves.

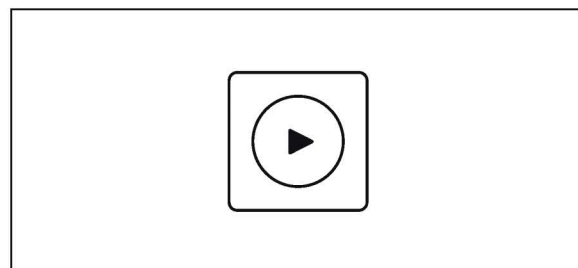

press play to hear your beat
and practice playing a
bassline over it.

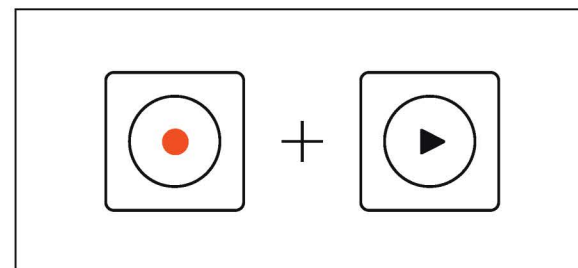

once you have something
you are happy with you can
try recording it in. press
record and play to arm the
track for recording.

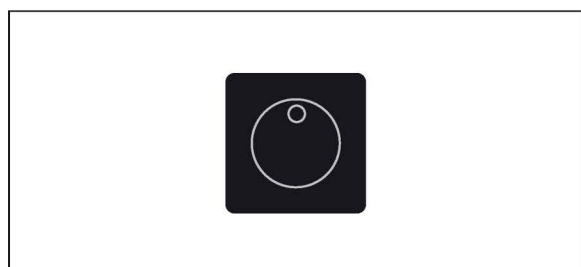

the first sequencer button
will start to flash red, letting
you know the sequencer is
armed to record.

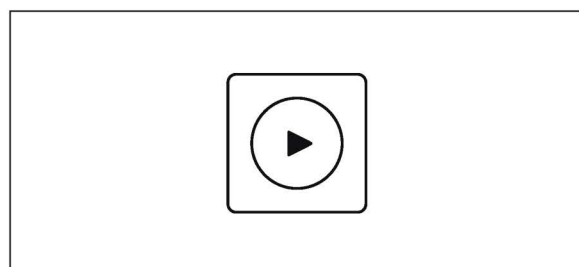

play the first note of your
bassline to instantly start
recording it and the
following notes. or
alternatively, press play to
start recording without
playing a note.

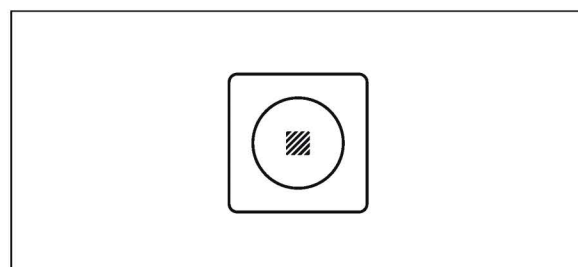

once you are done
recording press stop.

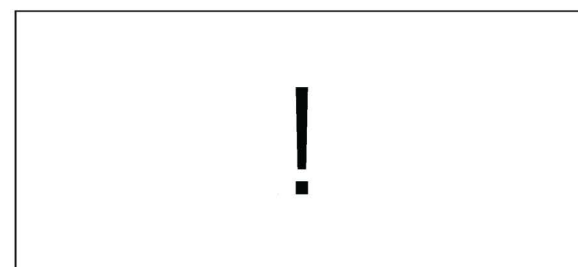

you may notice that your
bassline is longer than the
pattern it has been
recorded to, causing you to
play over yourself.

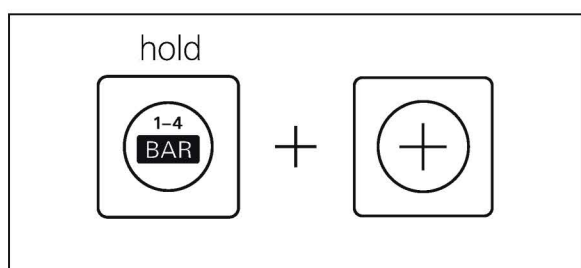

to extend your pattern hold
bar and press (+) to add
another bar. you can add up
to three extra bars, totalling
four bars in total.

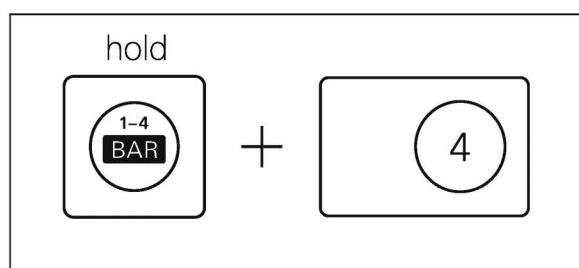

if you want an even longer
pattern, you can hold bar
and use the accidentals to
increase the track scale, this
will multiply the length of
each step giving you a
longer pattern.

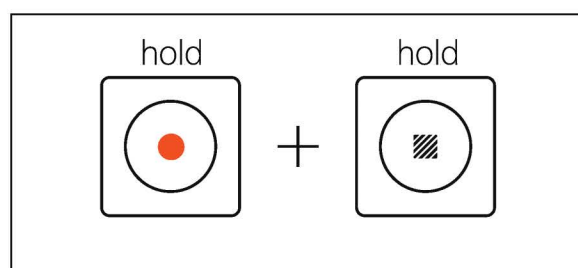

to delete the current
recorded sequence on a
track and start over just
hold record and stop until
the sequencer row fills up
red. you should then see an
empty sequence.

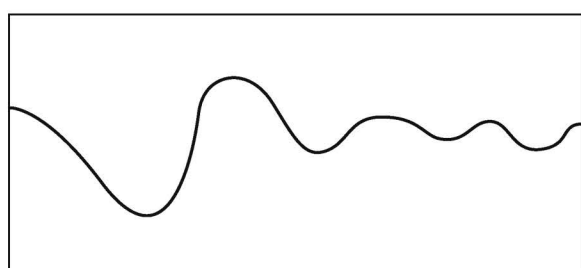
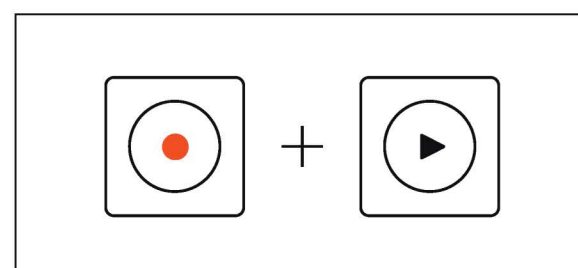

as a bonus, lets record
some automation on the
bassline.

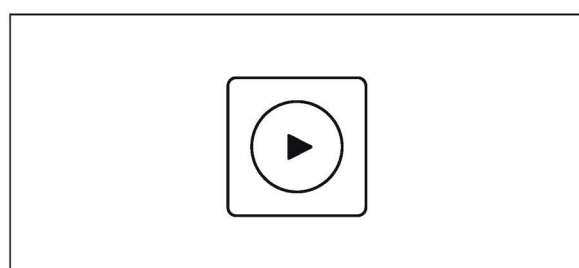

play your sequence.

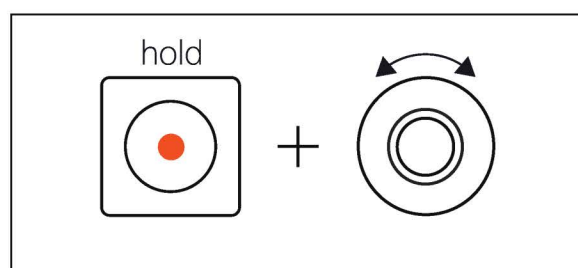

while playing, hold record
and turn one of the
encoders. this will record
that movement.

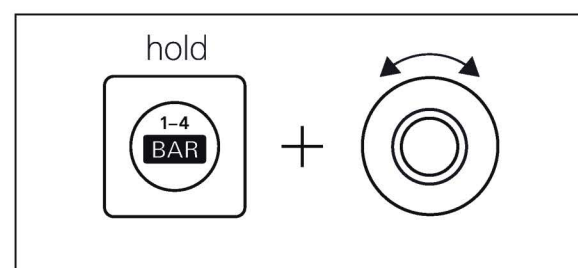

you may notice that this
movement is stepped. to
smooth it out hold bar and
rotate the white encoder.

4.3 adding chords

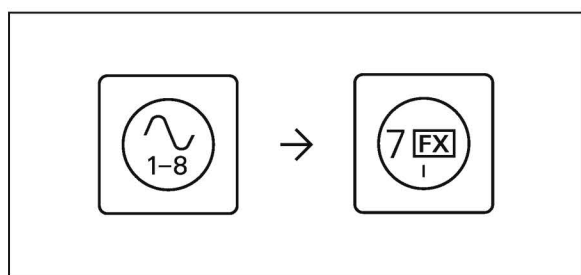

time to add some chords.
press instrument to make
sure you are in instrument
mode, then select track 7.

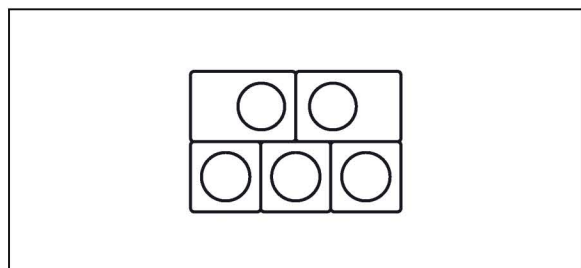

the musical keyboard will
play the 24 different notes.

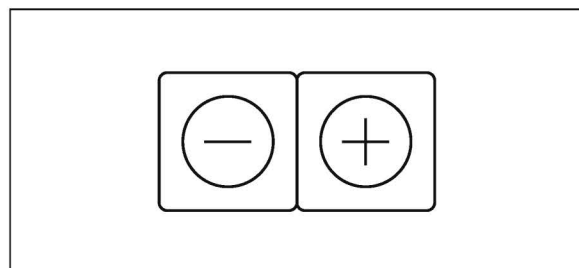

try playing some notes on
the keyboard. you can use
the (-) and (+) buttons to
change octaves.

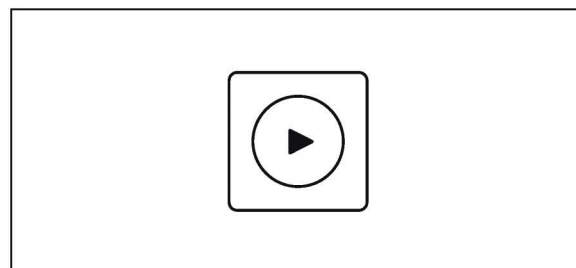

press play to hear your beat
and practice playing some
chords over it.

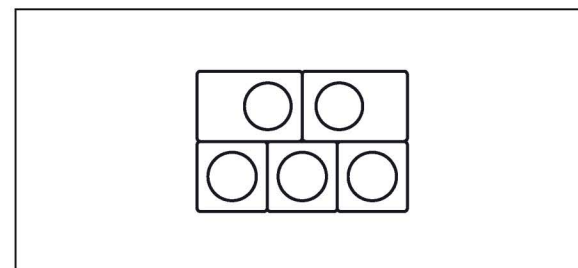

take note of where you
want the chords to play and
how long your sequence
might need to be, counting
the first beats in your head.

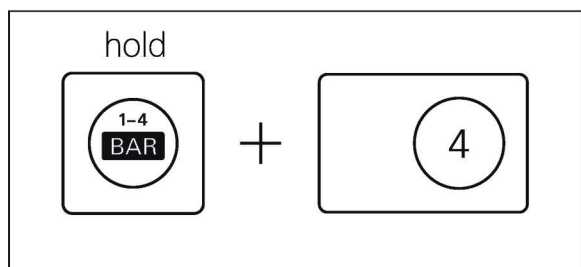

now we are going to
increase the track scale so
that each step represents
four steps and every four
steps is one bar. to do so,
hold bar and press the
accidental key labelled '4'
(the c# key).

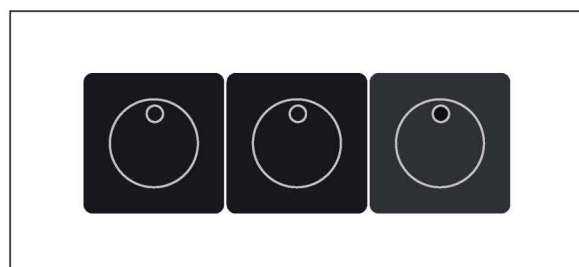

now press play and take
note of how each step
blinks four times rather than
once. you can practice your
chords, once again making
note of what steps they
play on.

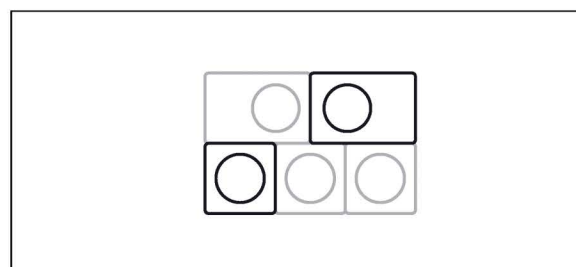

now, lets sequence the
chords to those steps. play
the chord on the musical
keyboard and hold the
notes down.

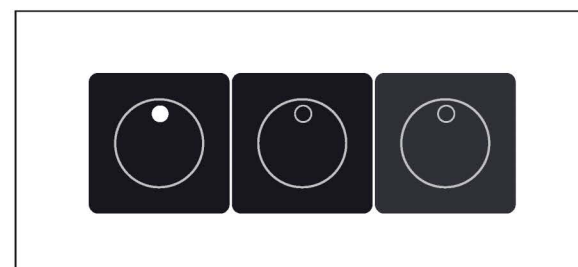

you may notice that your
bassline is longer than the
pattern it has been
recorded to, causing you to
play over yourself.

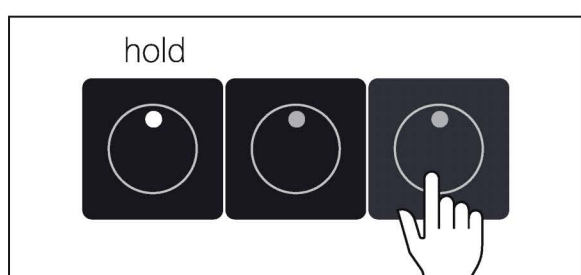

if you want to have the
chord hold across multiple
steps, just hold the step
with that chord down and
then press whatever step
you want it to be held until.

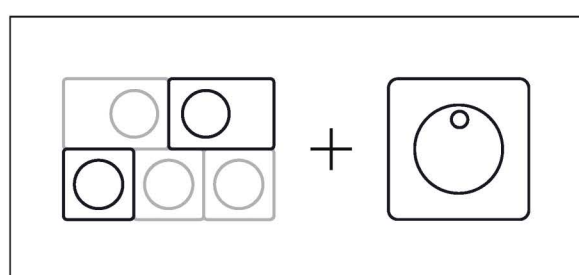

continue holding chords
and sequencing them in,
extending them as needed.

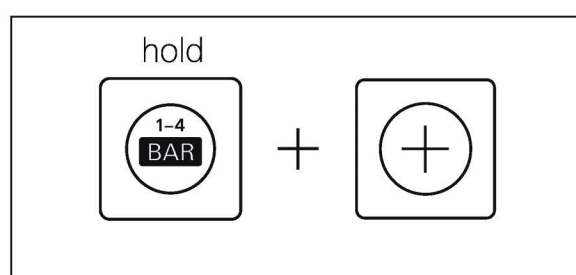

if you need a longer
sequence you can add
another bar by holding bar
and pressing (+).

4.4 adding punch-in FX™

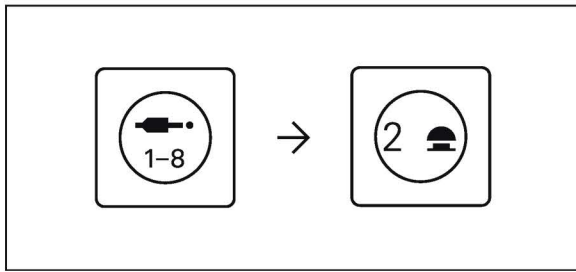

now let's perform the song with some punch-in FX™. press auxiliary to go to auxiliary mode then press track 2 to open the punch-in FX™ track.

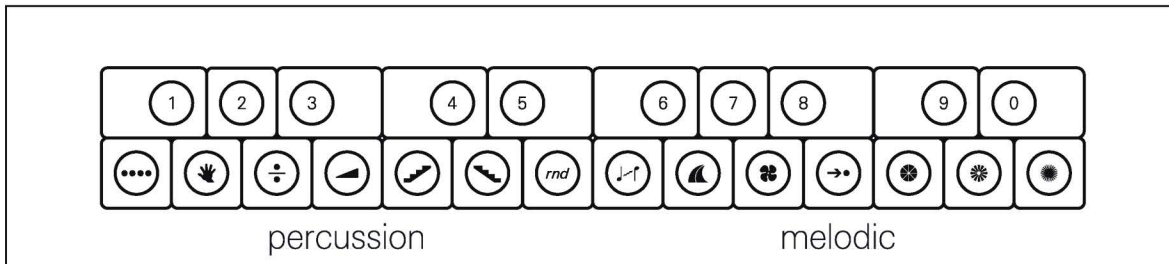

the musical keyboard will now be split into two sections; the first octave will control percussion tracks and the second octave will control melodic tracks.

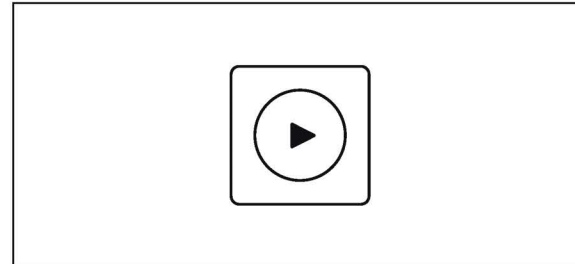

press play to start your song.

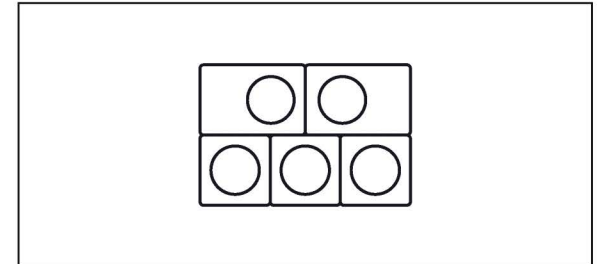

then press and hold notes on the musical keyboard. each note will have a different punch in effect. they can be combined for greater effect.



you can, as with any other track, sequence the punch-in FX™ with all the same techniques used already.

5. main modes and modules

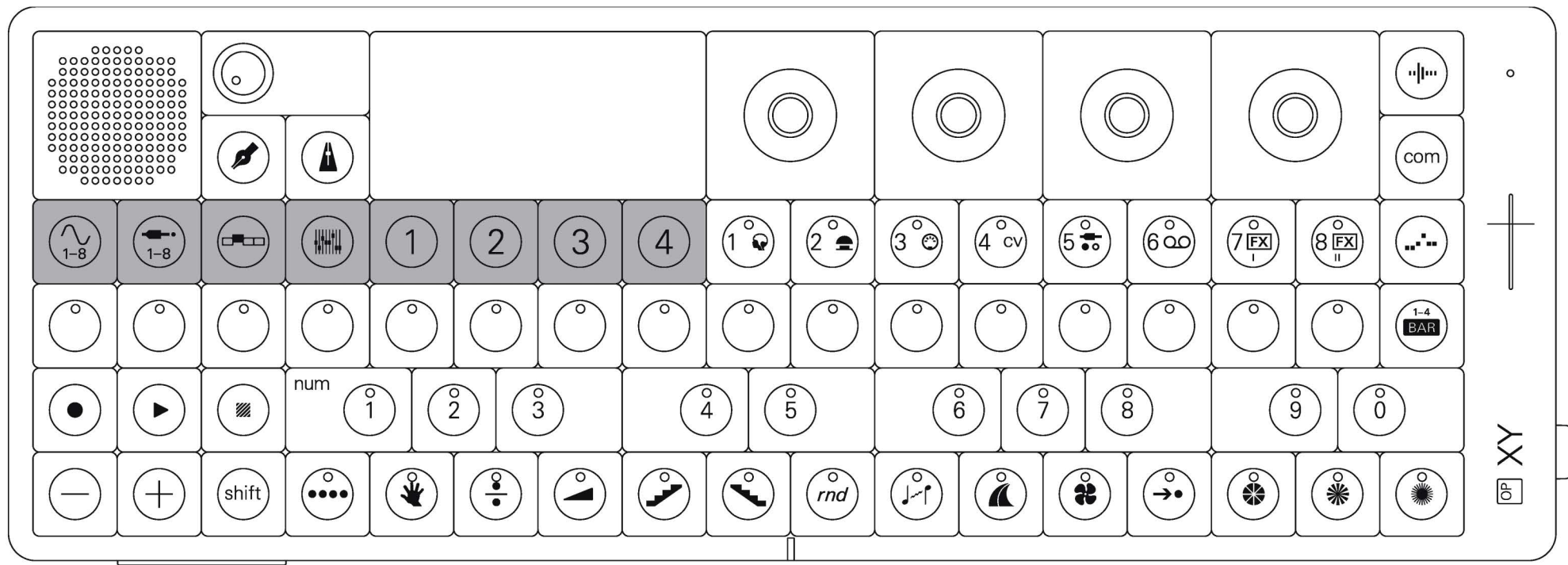

the four main modes: instrument, auxiliary, arrange and mix are where you'll spend the most time.

each mode represents a different section of the device. think of them as the different 'lifecycles' of a track: instrument is where you compose, auxiliary is where you transpose, arrange is where you start building and mix is just for that, mixing

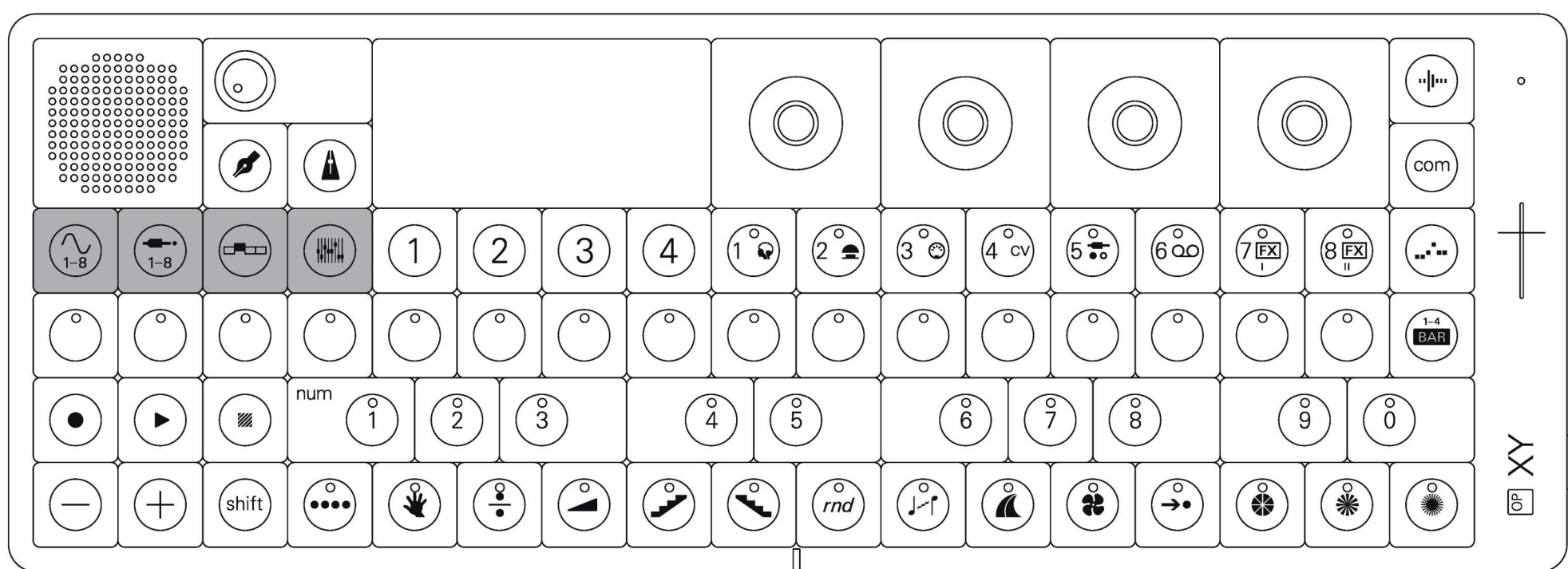

instrument

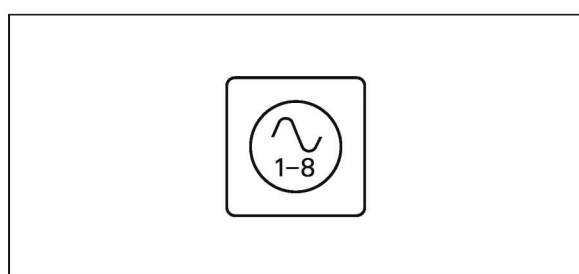

in instrument mode, the 8 track buttons allow you to control and edit the 8 instrument tracks available in the OP-XY.

auxiliary

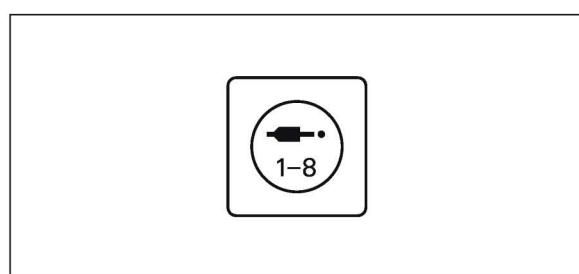

in auxiliary mode, the 8 track buttons allow you to intelligently transpose your tracks, edit the send effects, external inputs and outputs, as well as play and sequence punch-in FX™.

arrange

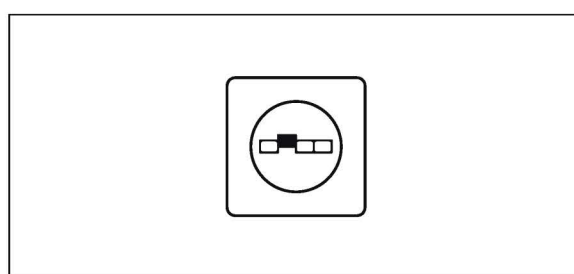

in arrange mode, you build your song by chaining scenes which are made up of patterns from your 8 tracks.

mix

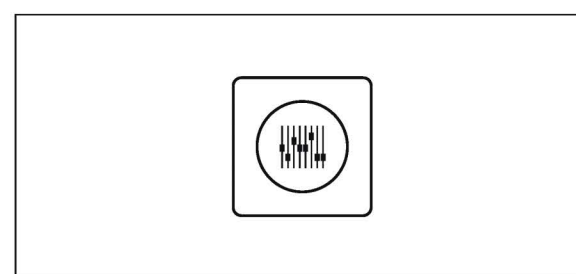

in mixer mode, you control levels and panning for each of the tracks as well as the main eq and master compressor.

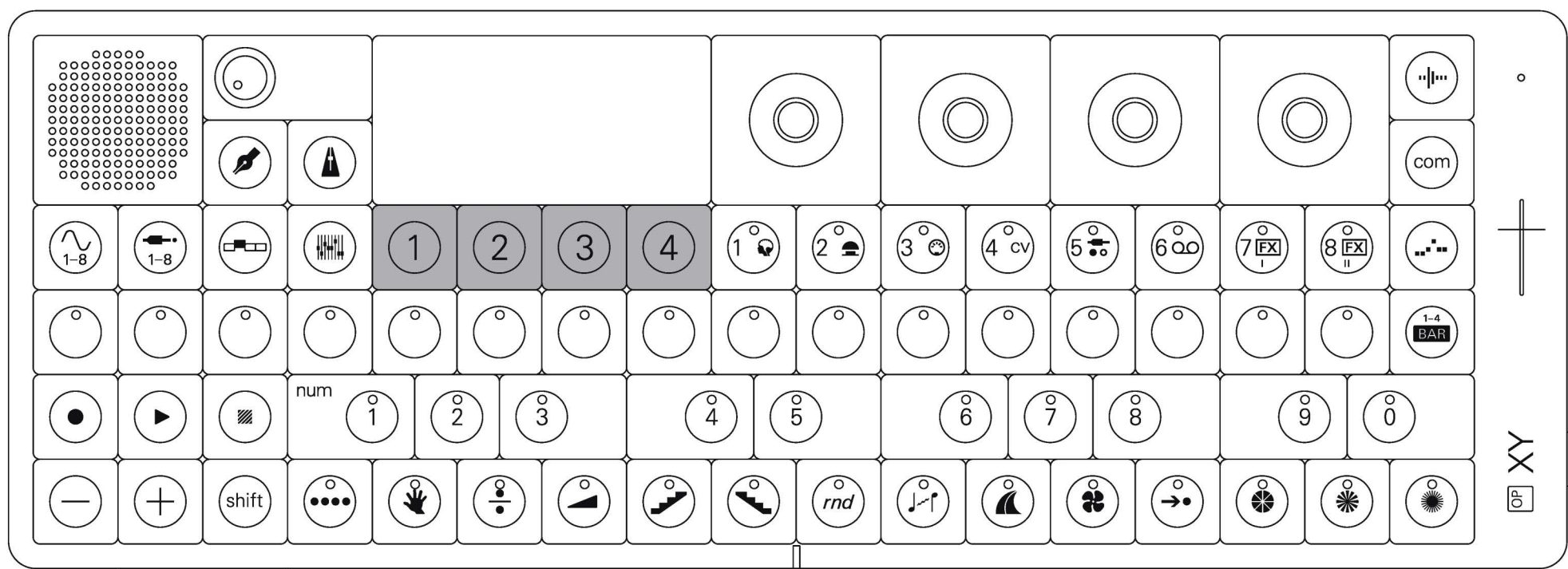

each main mode with the exception of arrange, features four sub modes called modules, these allow you to edit the various parameters within the selected track using the four encoders.

switch between the available modules using the four buttons underneath the screen. in some instances a screen may have extra parameters that can be accessed by holding shift.

M1

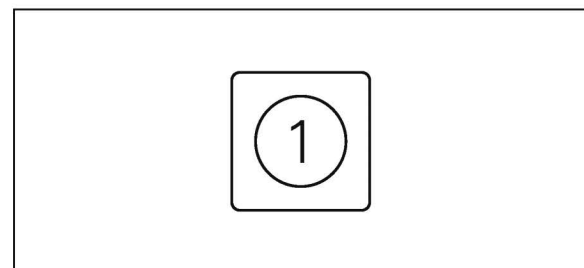

the button labelled (1) is referred to as M1.

M2

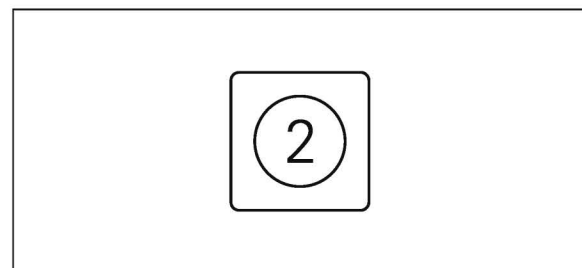

the button labelled (2) is referred to as M2.

M3

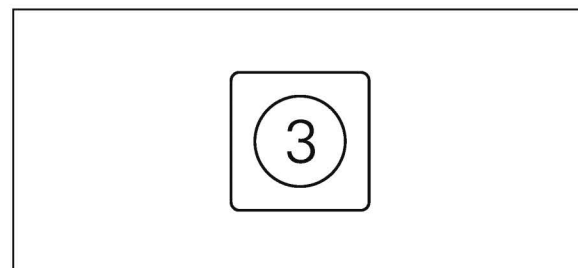

the button labelled (3) is referred to as M3.

M4

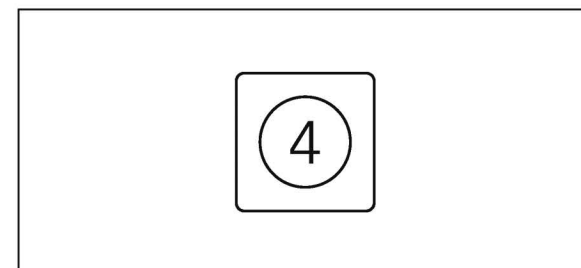

the button labelled (4) is referred to as M4.

6. track buttons

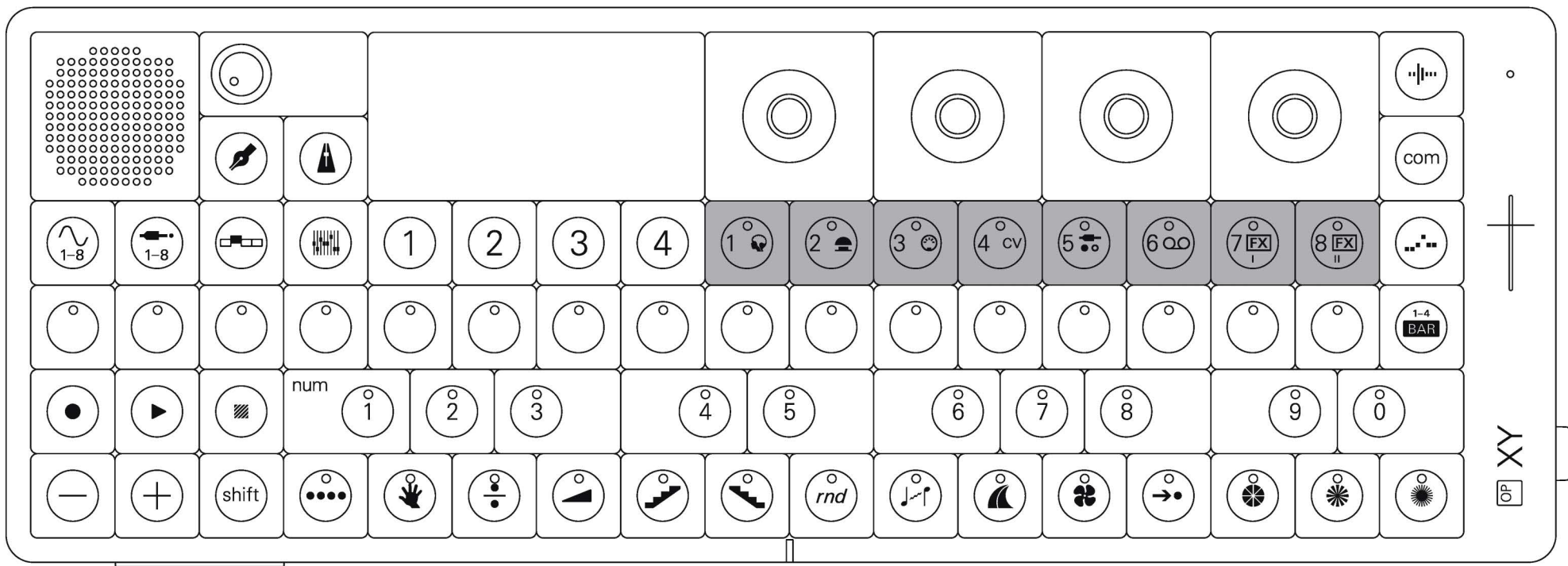

OP-XY's sequence-able tracks are divided into instruments and auxiliary tracks.

you can select the track you wish to sequence, edit, arrange or mix by pressing one of the track buttons, found underneath the encoders.

6.1 using the track buttons

active track



the active track is the track that you are currently sequencing, editing or arranging. the active track will light up in white if it is an instrument track, or red if it is an auxiliary track.

the numbered labels on each track button represent the 8 instrument tracks and the icons represent the 8 auxiliary tracks.

switching track

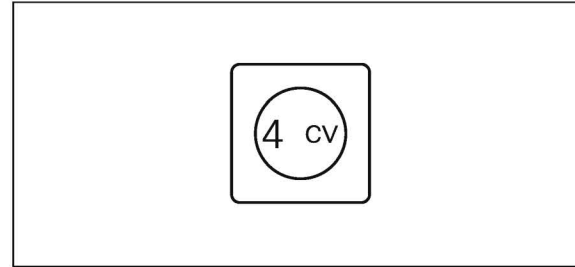

press any track button to switch sequencing, editing or arranging to that track.

presets

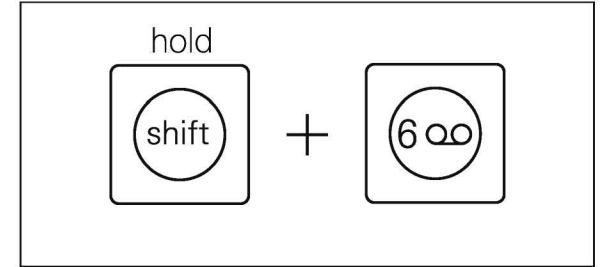

hold shift and press any track button to select a preset for that track. you can of course create your own presets.

6.2 linking tracks

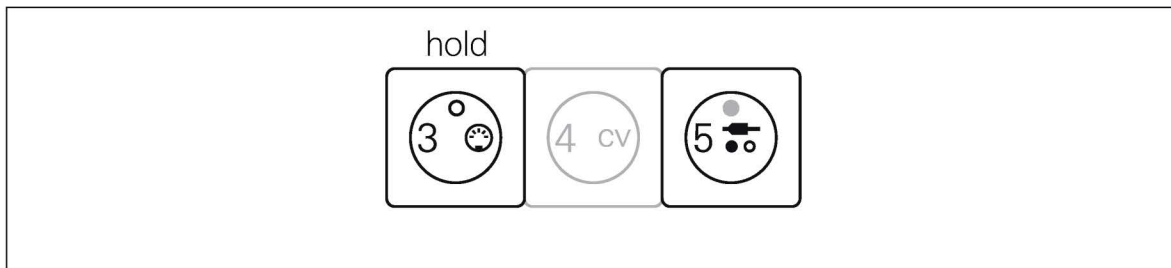

to link up to four tracks, just hold down one track button and press the tracks you would like to link it to.

the track you are holding down will then control all linked tracks. linked tracks can still be played separately from the primary track, as long as you are in the linked tracks, not the primary track.

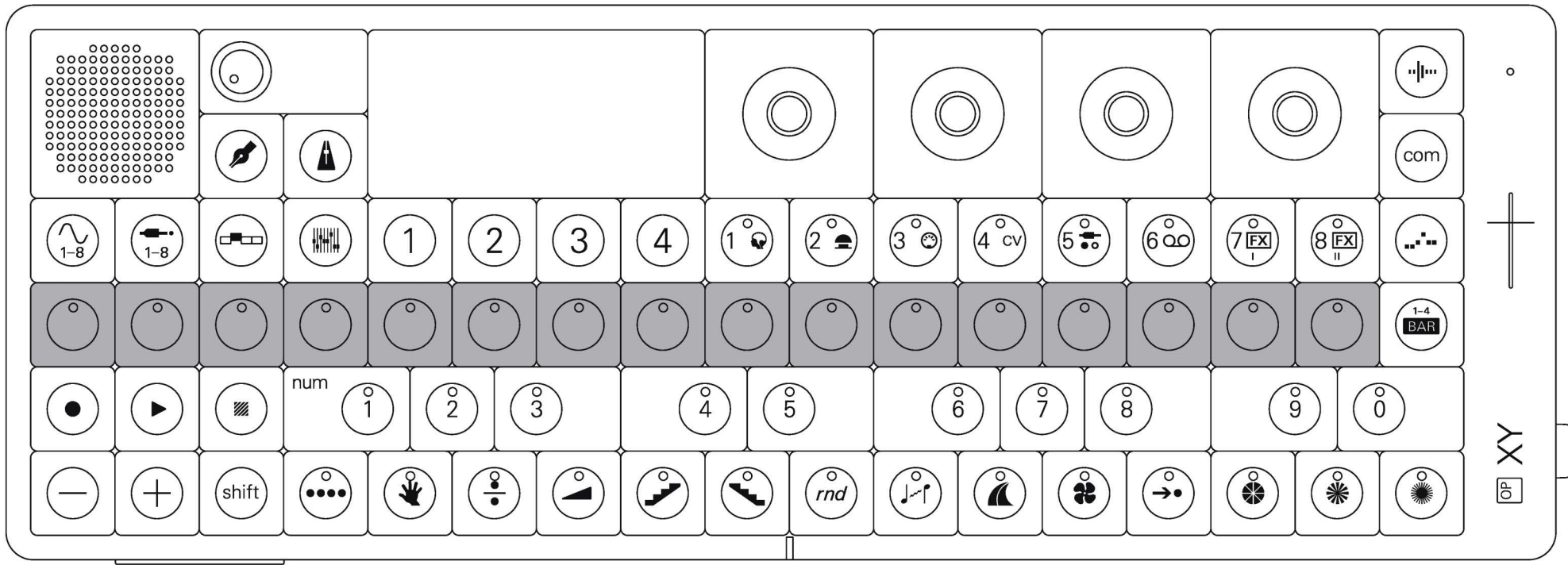

running across the length of the device is the step sequencer.

it is the heart of the OP-XY and represents the musical grid that sounds and notes are recorded to.

7.1 step sequencing

select note

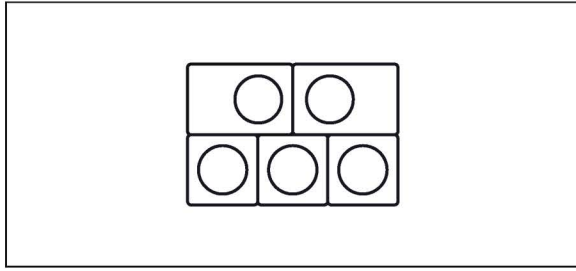

press a note or sound on the musical keyboard.

recall



whenever you play a note or sound, OP-XY will remember that note. when you next press a step it will record the last played note.

sequence note

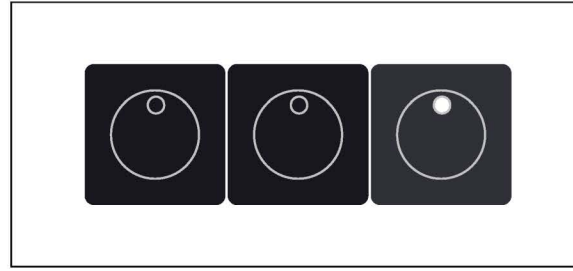

you can then press a step on the sequencer. the step will light up letting you know a note has been recorded to it.

check note

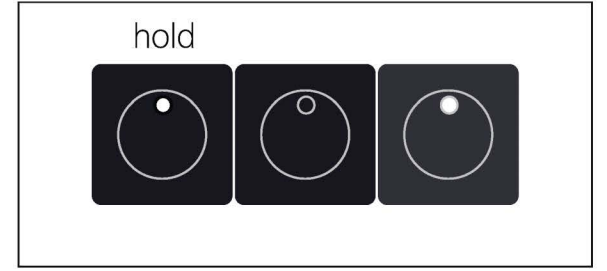

you can check the note recorded to a step by holding it down. the note or notes recorded to that step will then light up.

sequence chords

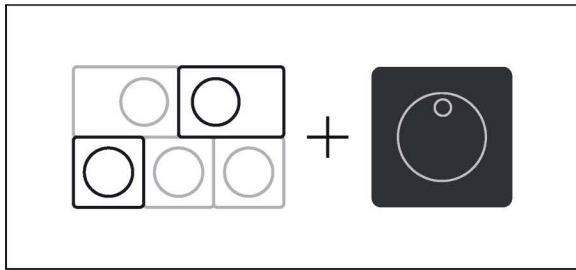

to step record multiple notes or chords, hold the notes or chord down then press the step you wish to record to on the sequencer.

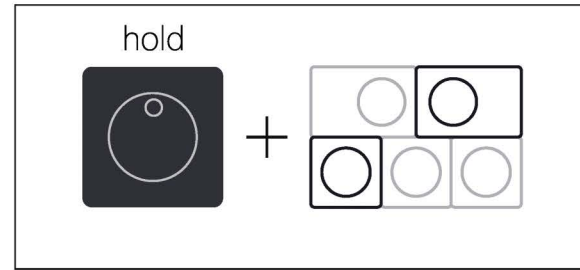

alternatively, hold a step down and play the notes you wish to record to that step.

edit step

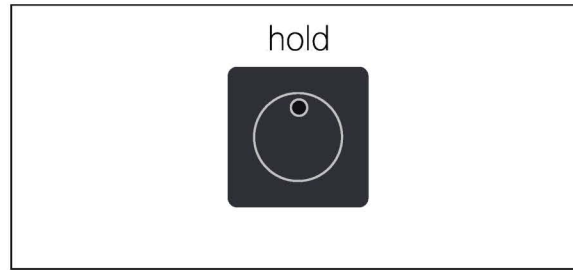

to add or remove a note or sound from a step, hold it down and then press that note to add or remove it.

extend note

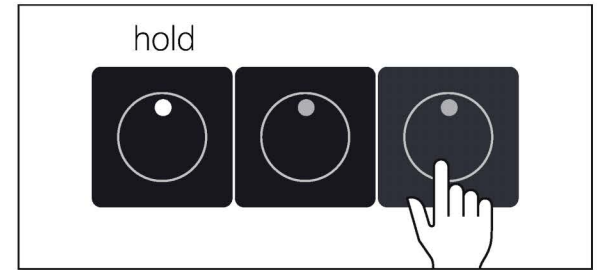

extend the length of a note or chord by holding a step and pressing another step. the location of the second step pressed will determine the length of the note.

nudge step

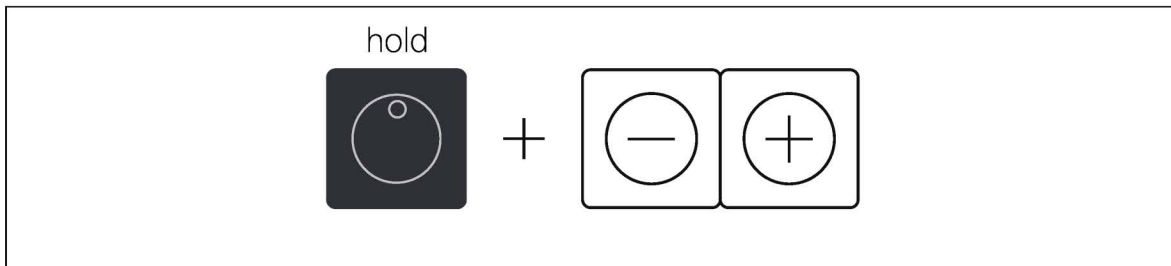

you can nudge steps by holding the step down then pressing (-) or (+).

this will allow you to break from the musical grid. notes can only be nudged when quantisation is set to 0. learn more about quantisation below.

sequence one sound only

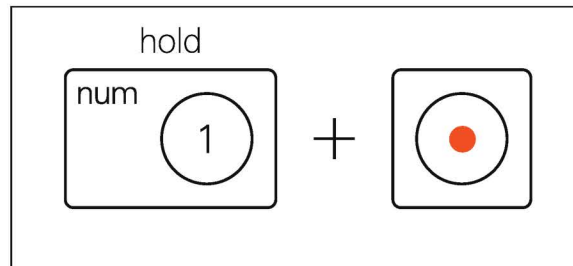

to view and sequence only one sound or note, hold the sound on the keyboard then tap record. this will then show you only the steps that note or sound has been recorded to. perfect for drum sequencing!

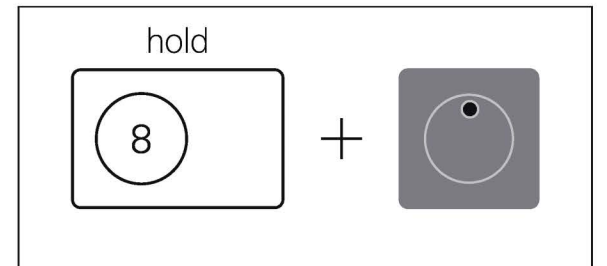

alternatively, you can hold a note down and then press the step sequencer to go directly into recording and viewing just that note.

parameter lock

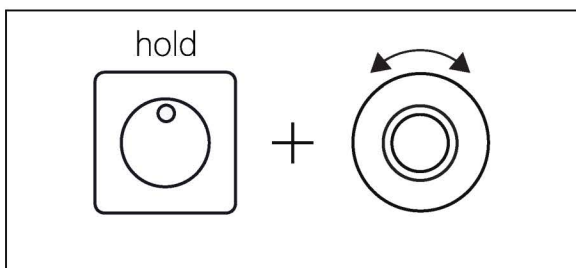

hold a step then rotate a knob to record a parameter 'lock' to that step. this will then set that parameter to the recorded value when playing back that step. all four modules can be locked but players cannot.

clear

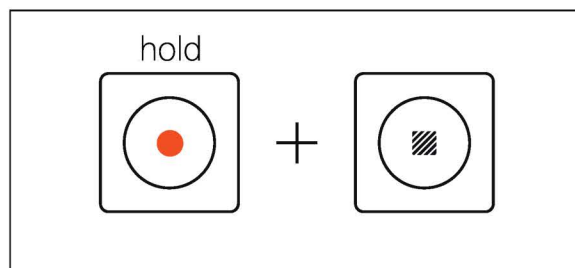

to clear everything you have recorded on the current track just hold record and stop until the red leds fill the sequencer.

undo

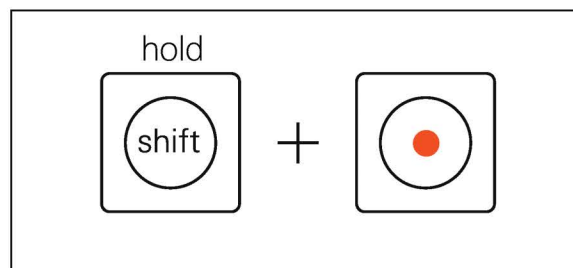

in some instances you may wish to undo a change. press shift and record to undo. it is only possible to undo certain actions. there is one undo stage.

live recording

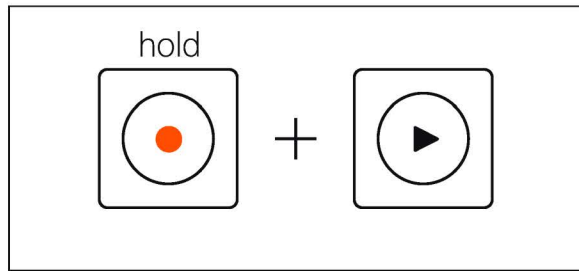

you can record steps to your patterns in a variety of ways. to live play notes, hold record and press play.

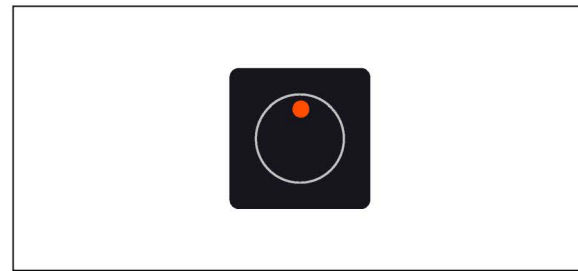

the step 1 key will flash red indicating it is waiting for you to start playing.

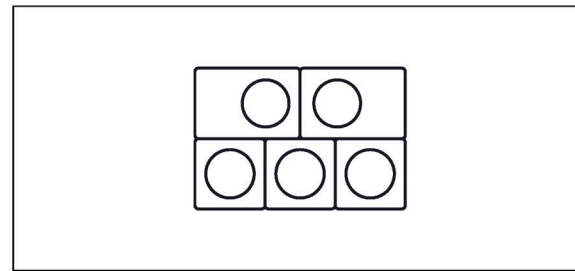

begin playing on the keyboard and the sequencer will start and record notes as you play them.

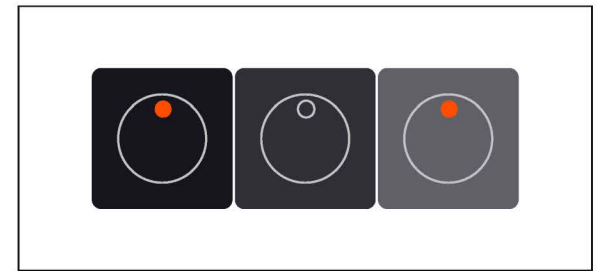

steps in the sequencer row will turn red to indicate there is a note recorded on that step.

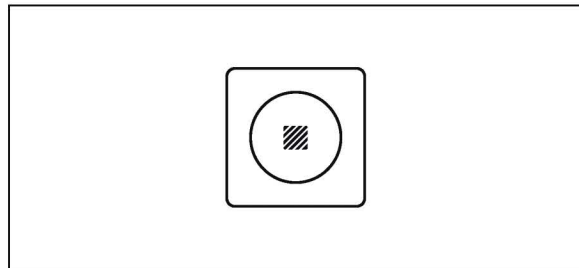

press stop.

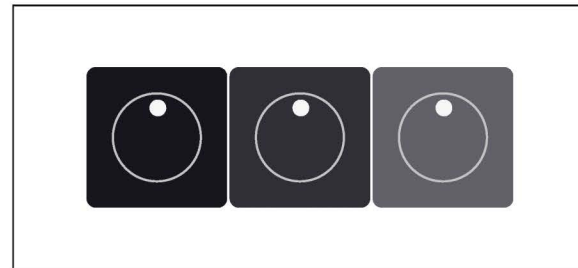

steps with notes will now be white.

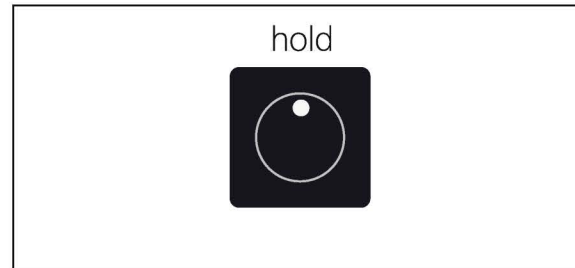

press and hold a step to see what has been recorded to that step. while holding, you may add or remove notes from the step by playing them on the keyboard.

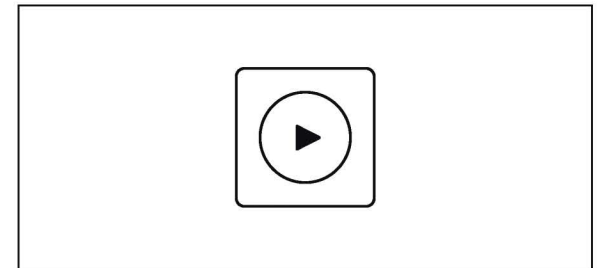

press play to listen to your song.

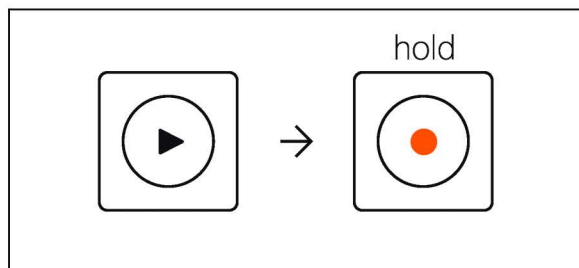

while your song plays, hold the record key and you can live record notes into your pattern.

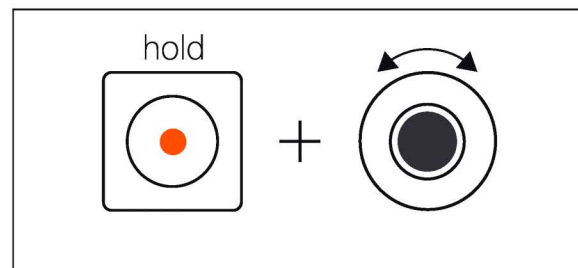

while playing, holding record and rotating a knob will automate that parameter and record the motion into the sequencer. by default this automation will not be smooth, as it records automation per step. to smooth, hold bar and rotate the white knob.

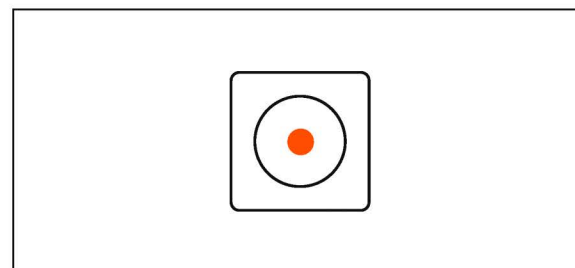

release the record key to continue listening to your song.

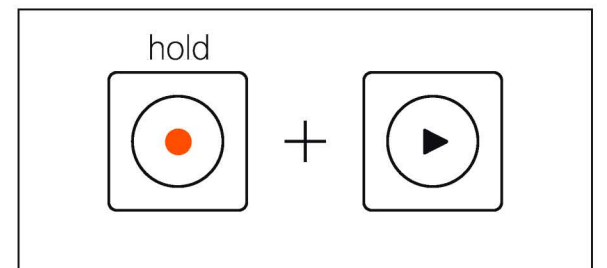

to remain in record mode while your song is playing, hold record and press play to lock recording mode.

7.3 step recording

step recording

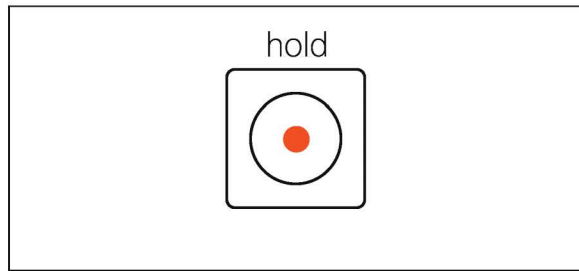

you can quickly record a sequence without running the sequencer. to step record, while paused hold record.

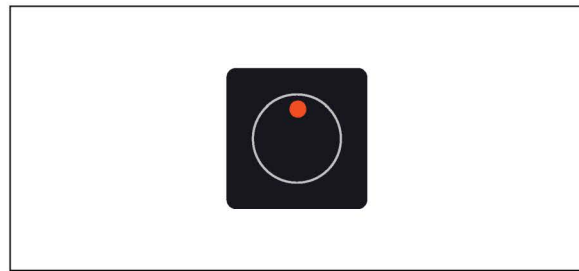

the step 1 key lights up red indicating it is waiting for you to start playing.

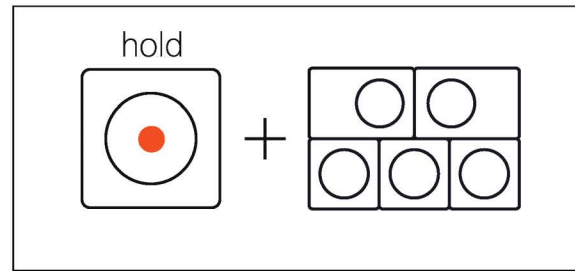

keep holding record and begin playing on the keyboard. the notes will fill the sequencer.

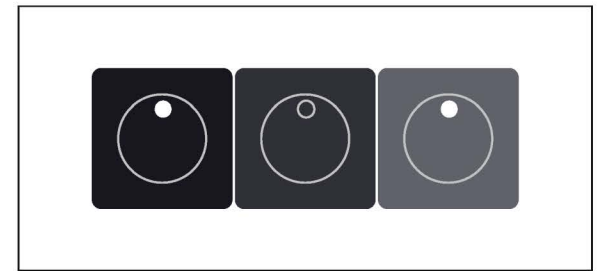

steps in the sequencer row will turn white to indicate there is a note recorded on that step.

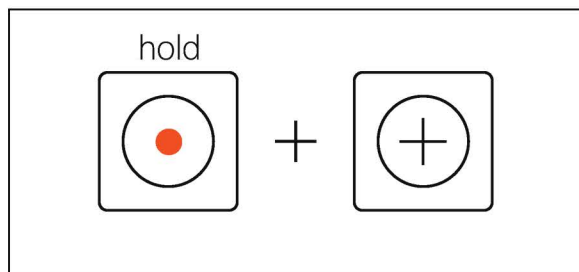

if you want to skip a step, while holding record just press the (+) button. the red led will move forwards to reflect the new record position.

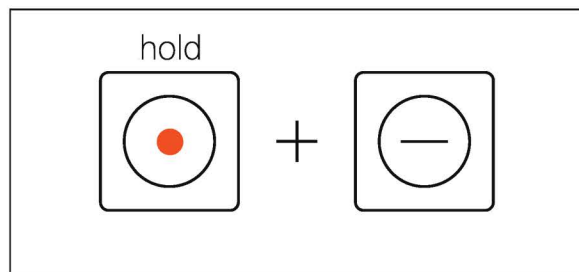

to go back a step, while holding record press the (-) button. the red led will move backwards to reflect the new record position, and if a sound has been recorded to the previous step, it will play and it's key will light up, ready for you to edit it.

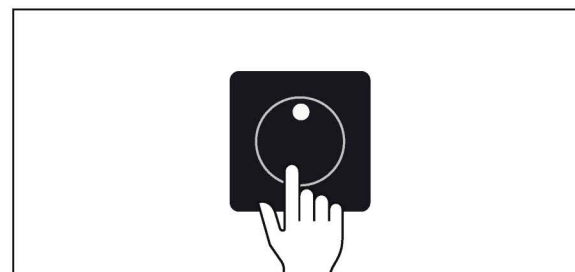

if you made a mistake and want to remove a step completely, just tap it to remove it from the recording.

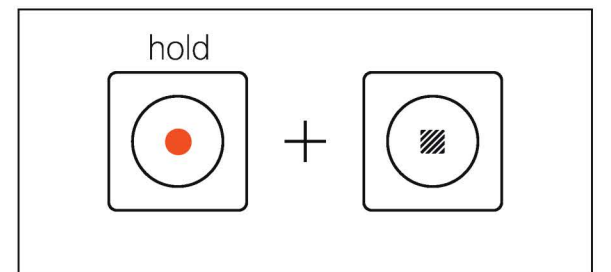

to clear everything you have recorded on the current track just hold record and stop until the red leds fill the sequencer.

7.4 extending your sequence with bar

bar

on the far right of the sequencer you will find bar. bar is the gateway to longer and more complex sequences and allows you to extend your sequences, apply quantisation, lengthen notes, apply grooves and smooth automation.

track scale

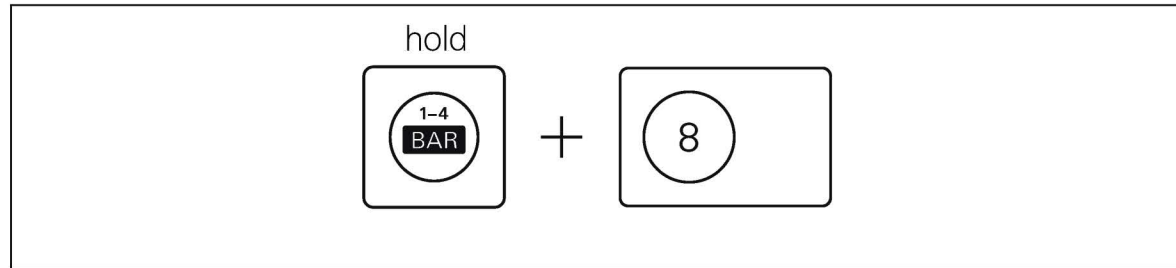

hold bar and press an accidental key to change the track scale. track scale determines the amount of time taken up by one step. this can be set per track independently.

available track scales include:
1, 2, 3, 4, 6, 8, 16, 1/2

add bars

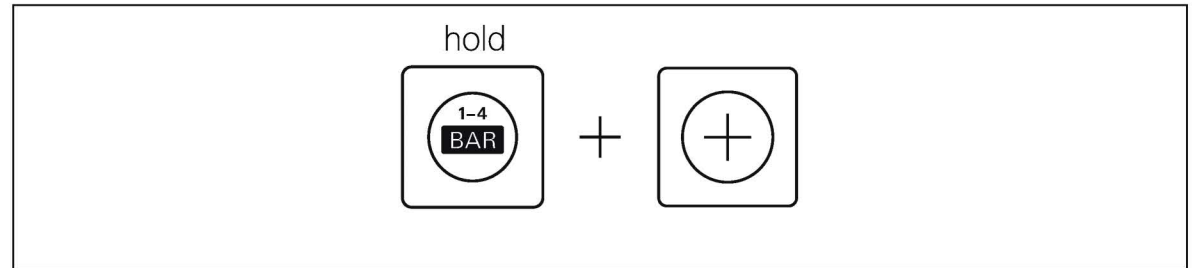

hold bar and press (+) to add bars. remove a bar by pressing (-). bars allow you to increase the number of steps available for sequencing.

a maximum of four bars can be used. this in combination with the track scale allows for a maximum pattern length of 64 bars, or 1024 1/16th notes spread across four 'bars'.

duplicate bar

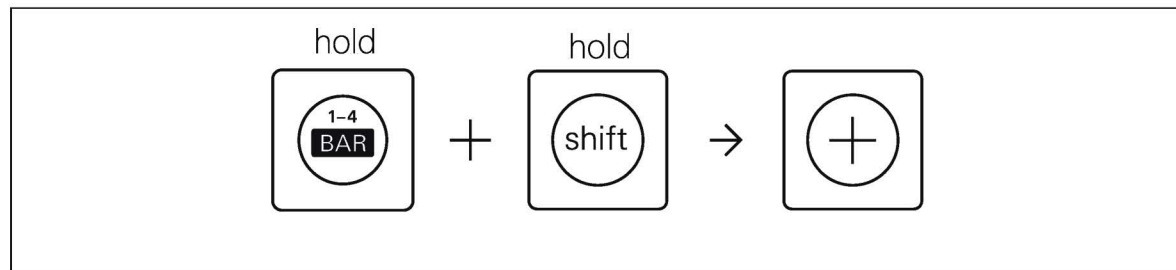

holding bar and shift, then pressing (+) will duplicate the current bar. for two bar phrases the first will copy to the third and the second to the fourth.

sequence length

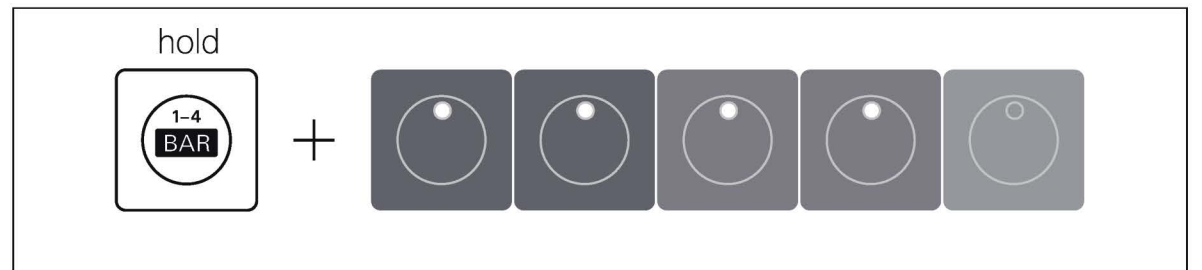

holding bar and pressing the step sequencer allows you to select the number of steps in a pattern. when sequencing patterns with multiple bars this will alter the length of the final bar, all others will be the full length.

switch bar

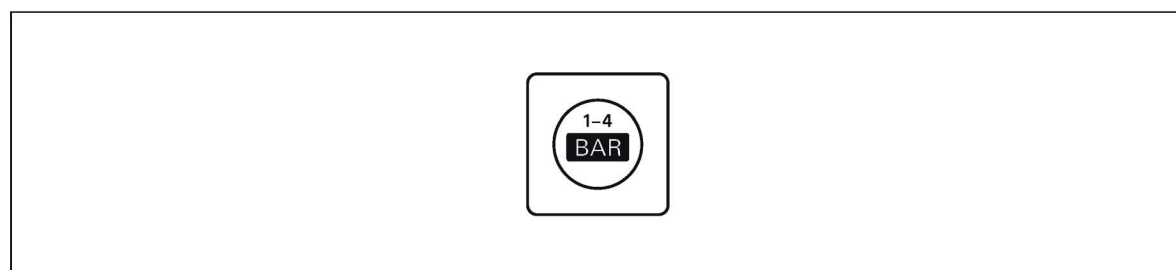

press or tap bar to switch between bars. if you switch bars while playing or recording it will stay on the selected bar, allowing you to sequence just that bar without interruption.

quantisation

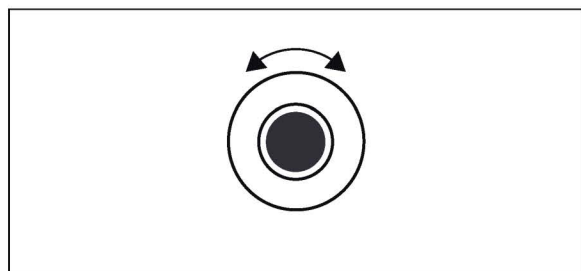

rotate the dark gray knob to adjust track quantization. this will adjust the timing of whatever you live record into the current track. with quantization set to 100 you cannot nudge notes.

length

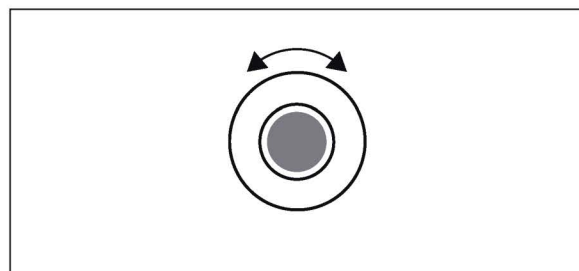

rotate the mid gray knob to adjust the length of step sequenced notes. this does not apply to live recorded or extended notes.

groove

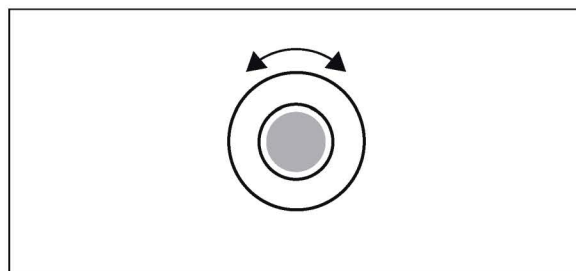

rotate the light gray knob to adjust the groove applied to the current track, this will overwrite the swing value in tempo. you can select the groove style in the tempo screen.

shape

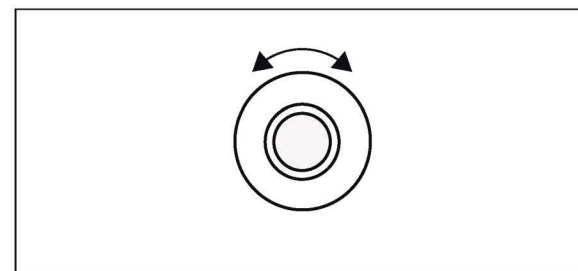

rotate the white knob to adjust the smoothing between parameter locks. by default parameter locks and recorded automation will have no smoothing.

clear notes

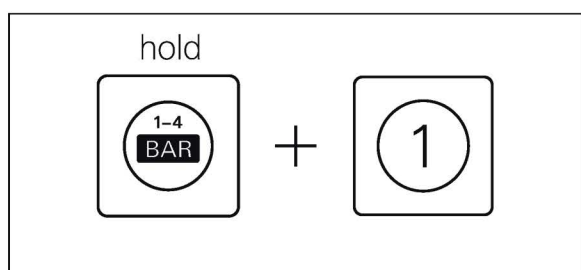

while holding bar, press M1 to clear notes. this will delete the notes but not the parameter locks.

clear params

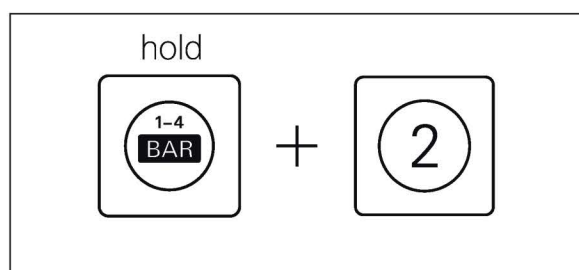

while holding bar, press M2 to clear parameter locks. this will delete the parameter locks but not the notes.

clear all

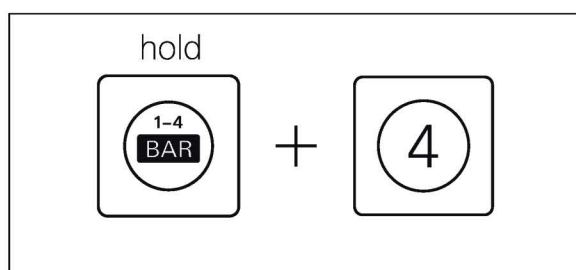

while holding bar, press M4 to clear all notes and parameter locks from the pattern.

lock bar on screen

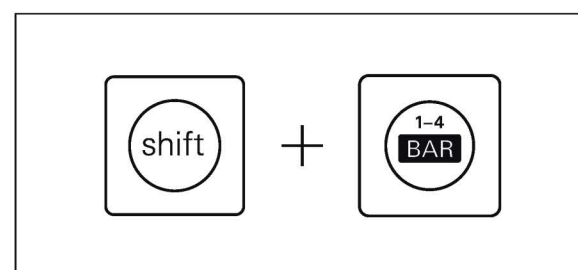

press shift and bar in combination to keep the bar button held down for you, this will keep the bar page on screen until you press bar again.

8. step components

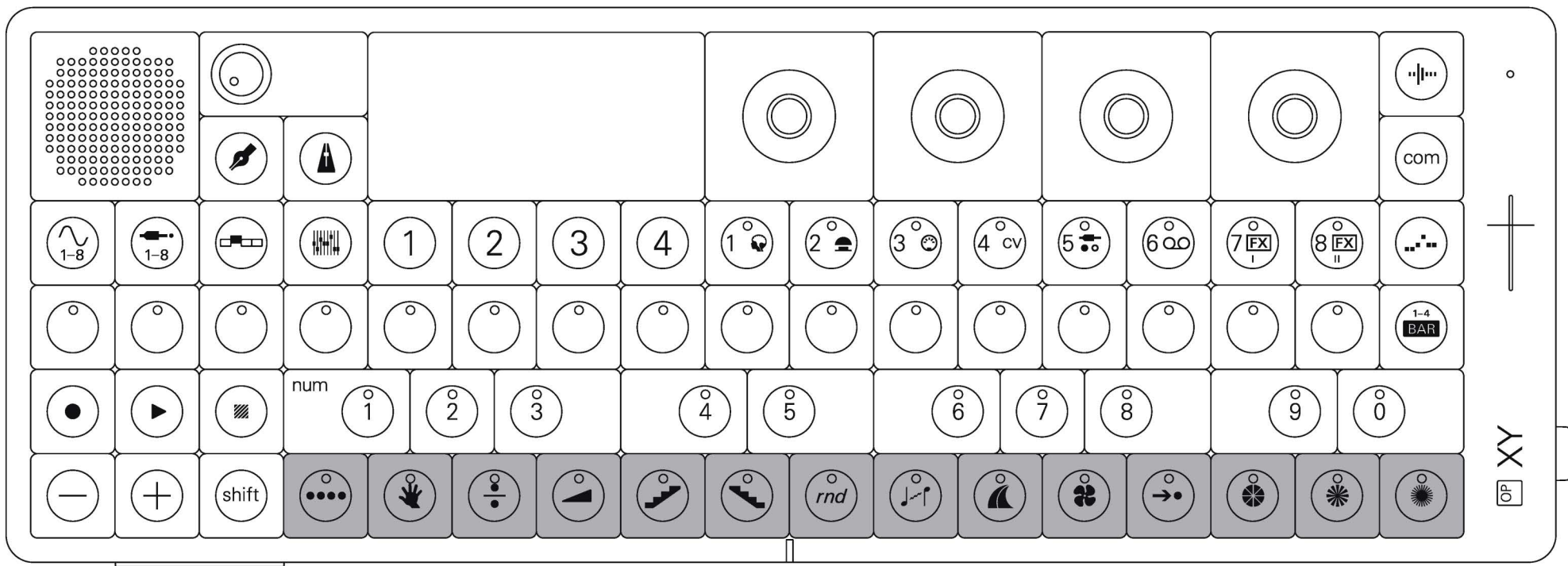

OP-XY features a powerful sequencing tool called step components.

step components allow for rapid variations to be applied to specific steps and are an amazing way to expand the capabilities of the sequencer.

8.1 what are step components?

step components are variations that can be added to any step on the sequencer and can alter everything from randomizing pitch to bending, skipping or even multiplying steps.

mastering step components can take you from an idle songwriter to a professional. realize your most fleeting ideas into full tracks in just a few seconds.

8.2 adding step components to a sequence

make a sequence

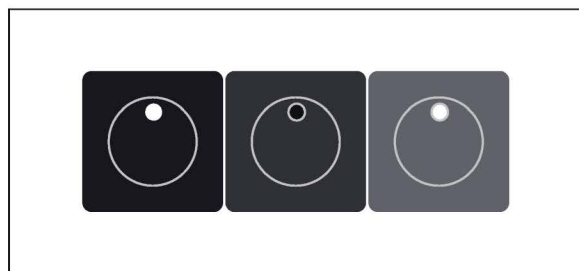

start off by programming a basic sequence on any track.

hold shift

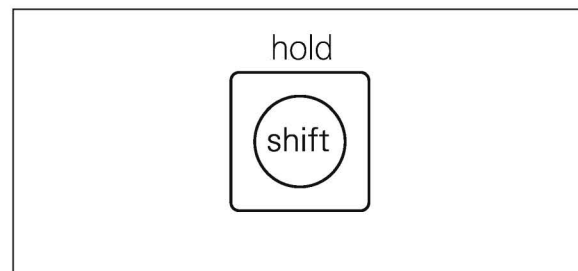

hold shift. this will dim the steps with notes recorded to them, telling you that no step components are added to those steps.

select steps

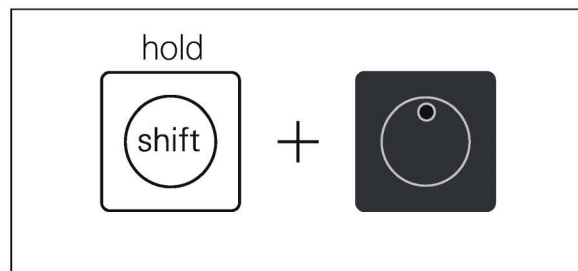

while continuing to hold shift, select the steps you wish to add step components to. they will flash to let you know they have been selected.

choose natural

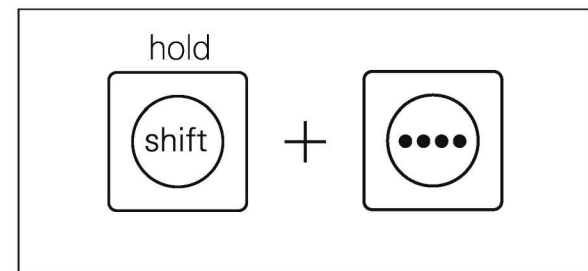

continue holding shift and then choose one of the natural keys. each natural key has a different step component, represented by the icon printed on its face.

modify

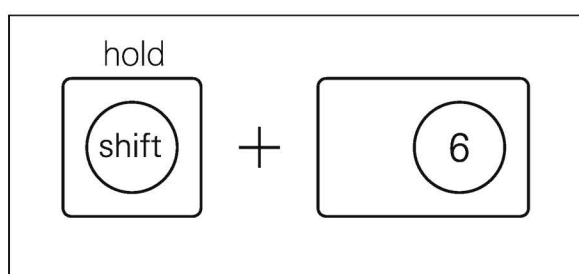

once you have selected a step component, continue to hold shift and then use the accidental keys to choose the value for that step component. each step component uses the accidentals differently. you can see exactly what they modify on the screen.

play

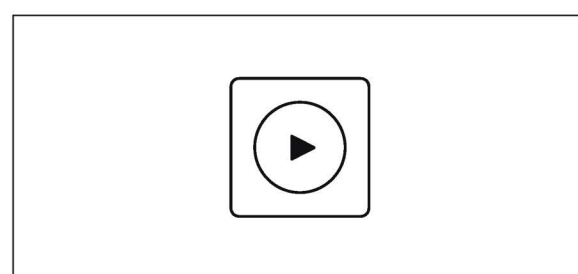

let go of shift. now that you have added a step component, press play and you can hear it applied to the selected steps

remove step component

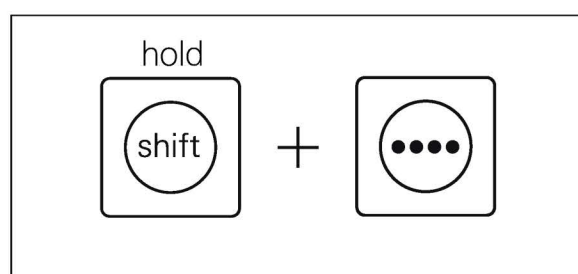

should you wish to remove a step component, just hold shift, select the steps again and press the natural key for the step component applied.

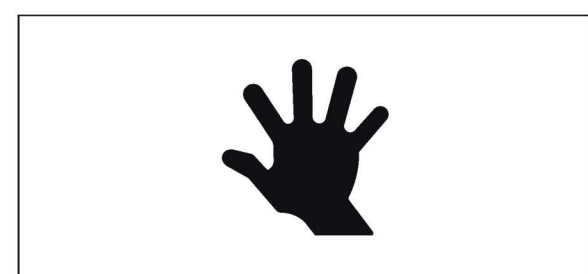

each step can have any combination of all 14 step components applied, so experiment with combining them and see what you can create.

8.3 what step components are there?

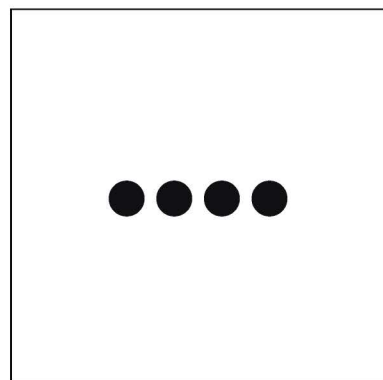

pulse

pulse repeats a step a defined number of times without progressing the sequence. use the accidentals to select the number of pulses.

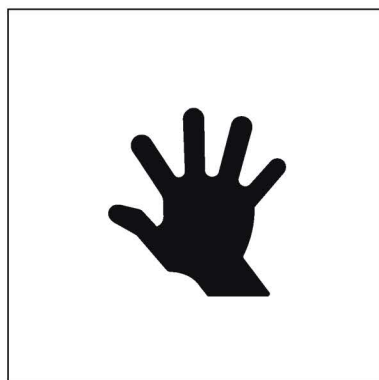

hold

hold will hold a step a defined number of steps without progressing the sequence. use the accidentals to select the number of steps to hold.

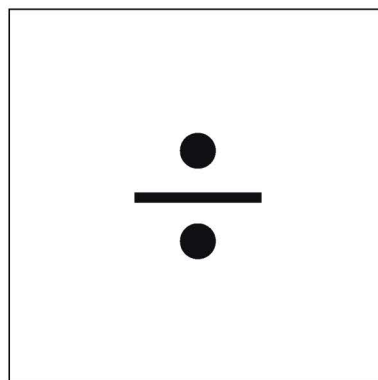

multiply

multiply will multiply the number of triggers in a step, creating a ratchet effect, perfect for hi-hats. use the accidentals to select the number of trigs.

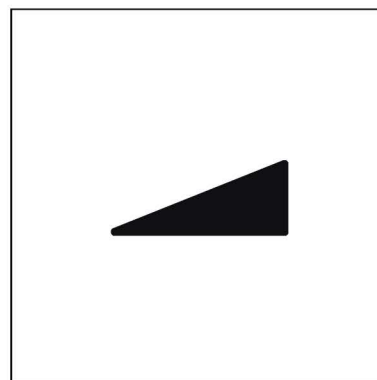

velocity

velocity allows you to set the velocity on a step to a defined value. use the accidentals to set the velocity value.

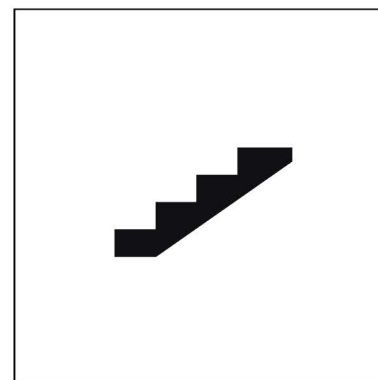

ramp up

ramp up alters the note of the selected step by following a ramp in the current scale. each time the step is triggered, the note increments up the ramp. use the accidentals to select the interval.

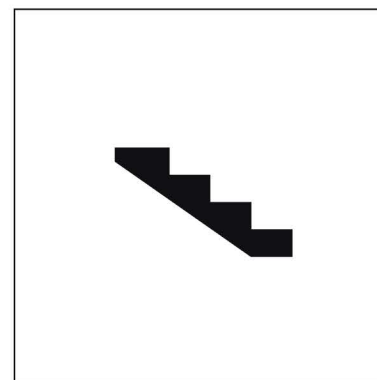

ramp down

ramp down alters the note of the selected step by following a ramp in the current scale. each time the step is triggered, the note increments down the ramp. use the accidentals to select the interval.

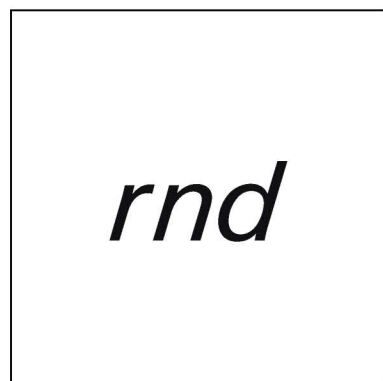

random

random will randomize the notes on the selected steps inside of the current scale. use the accidentals to set the range of possible notes.

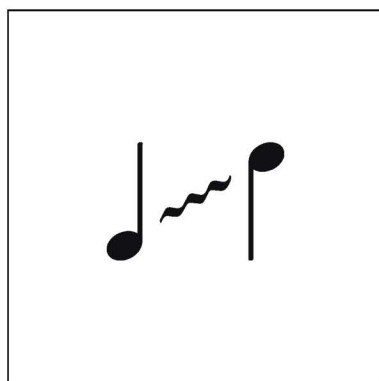

portamento

portamento will apply portamento to and from the selected step. use the accidentals to select the amount of portamento.



bend

bend will apply a pitch bend to the selected steps, different bend patterns can be found on the accidentals so try them out for some cool pitch effects.

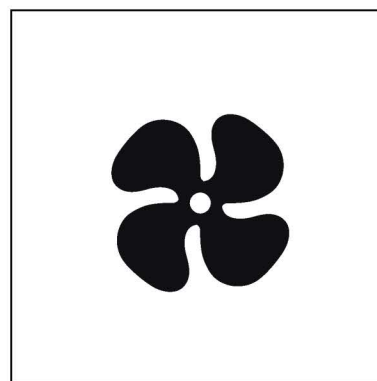

tonality

tonality allows you to transpose the selected step by a fixed interval. use the accidentals to set the transposition interval.

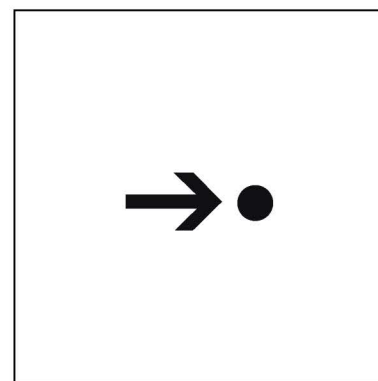

jump

use jump to usurp steps and skip to a chosen step. use the accidentals to select which step to jump to.

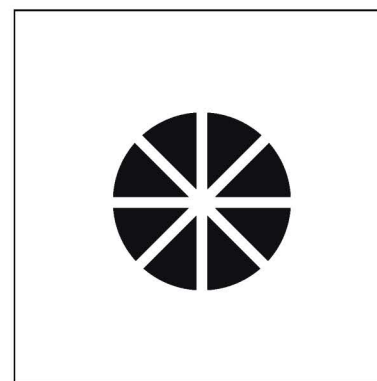

skip parameter lock

skip parameter lock allows you to play a parameter lock on a step every defined number of repetitions, perfect for having automation on only one out of every few repetitions.

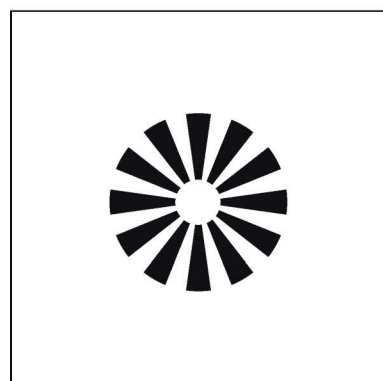

skip step component

skip step component allows you to play only one out of every defined number of repetitions. use the accidentals to select the number of repetitions.

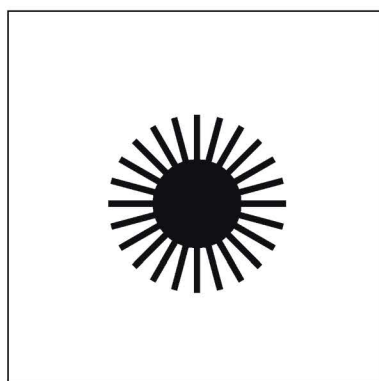

skip trigger

skip trigger allows you to play only one in every defined number of repetitions. this is perfect for adding variations to your sequence every few repetitions.

8.4 step component reference table

	name	1	2	3	4	5	6	7	8	9	0
	pulse	repeat step 1 time	repeat step 2 times	repeat step 3 times	repeat step 4 times	repeat step 5 times	repeat step 6 times	repeat step 7 times	repeat step 8 times	repeat step 9 times	repeat step random times
	hold	hold step 1 time	hold step 2 times	hold step 3 times	hold step 4 times	hold step 5 times	hold step 6 times	hold step 7 times	hold step 8 times	hold step 9 times	hold step random times
	multiply	divide into 1 trig	divide into 2 trigs	divide into 3 trigs	divide into 4 trigs	divide into 5 trigs	divide into 6 trigs	divide into 7 trigs	divide into 8 trigs	divide into 9 trigs	divide into random trigs
	velocity	force velocity to 4	force velocity to 8	force velocity to 16	force velocity to 32	force velocity to 64	force velocity to 100	force velocity to 112	force velocity to 127	force velocity to 0	force velocity to random
	ramp up	ramp 2 steps 1 octave	ramp 3 steps 1 octave	ramp 4 steps 1 octave	ramp 5 steps 1 octave	ramp 6 steps 1 octave	ramp 2 steps 3 octaves	ramp 3 steps 3 octaves	ramp 4 steps 3 octaves	ramp 5 steps 3 octaves	ramp 6 steps 3 octaves
	ramp down	ramp 2 steps 1 octave	ramp 3 steps 1 octave	ramp 4 steps 1 octave	ramp 5 steps 1 octave	ramp 6 steps 1 octave	ramp 2 steps 3 octaves	ramp 3 steps 3 octaves	ramp 4 steps 3 octaves	ramp 5 steps 3 octaves	ramp 6 steps 3 octaves
<i>rnd</i>	random	2 steps 1 octave	3 steps 1 octave	4 steps 1 octave	5 steps 1 octave	6 steps 1 octave	2 steps 3 octaves	3 steps 3 octaves	4 steps 3 octaves	5 steps 3 octaves	6 steps 3 octaves
	portamento	portamento amount 10%	portamento amount 20%	portamento amount 30%	portamento amount 40%	portamento amount 50%	portamento amount 60%	portamento amount 70%	portamento amount 80%	portamento amount 90%	portamento random amount
	bend	bend shape down up	bend shape up down	bend shape bump down	bend shape bump up	bend shape spring out	bend shape spring in	bend shape fade down	bend shape fade up	bend shape random 1	bend shape random 2
	tonality	ignore chord progression	transpose only	octave up	fifth up	third up	chromatic up	chromatic down	quantize 33%	quantize 66%	quantize 100%
	jump	jump to step 1	jump to step 5	jump to step 9	jump to step 13	jump one step forward	jump one step back	jump forward or back	stay on step	align track position	jump to random step
	parameter	play every param lock	play every 2nd param lock	play every 3rd param lock	play every 4th param lock	play every 5th param lock	play every 6th param lock	play every 7th param lock	play every 8th param lock	play every 9th param lock	play random param lock
	component	play every component	play every 2nd component	play every 3rd component	play every 4th component	play every 5th component	play every 6th component	play every 7th component	play every 8th component	play every 9th component	play random component
	trig	play every trig	play every 2nd trig	play every 3rd trig	play every 4th trig	play every 5th trig	play every 6th trig	play every 7th trig	play every 8th trig	play every 9th trig	play random trig

9. players

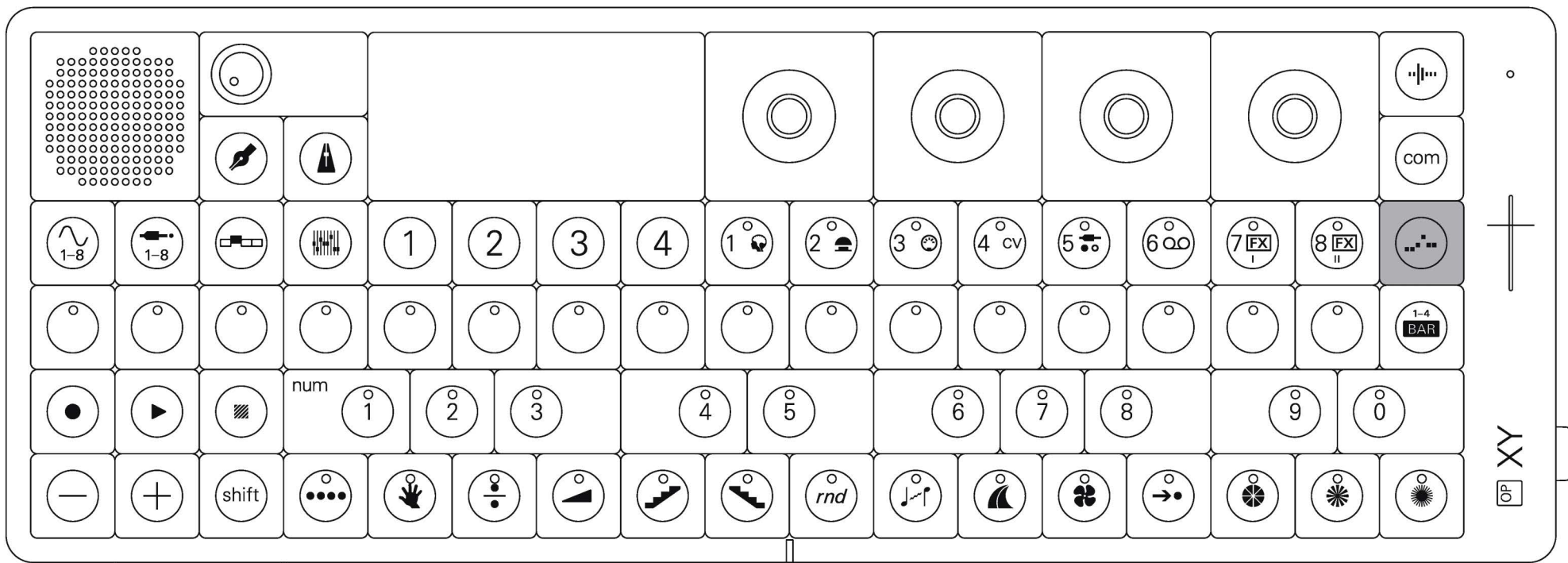

on each track, a player can be added.
 players create player-style variations on existing
 sequences such as arpeggios and chords triggers.

add a player to a track

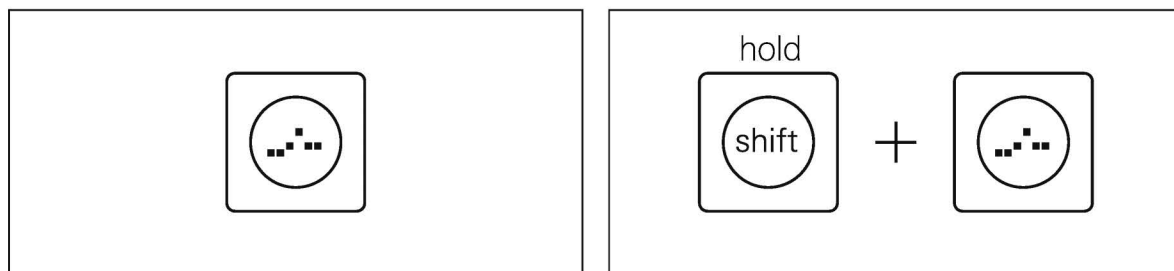

in any instrument or
 auxiliary track press player
 to open the player, then
 press it again to enable it.

hold shift and press player
 to change the player style.

9.1 arpeggio

speed

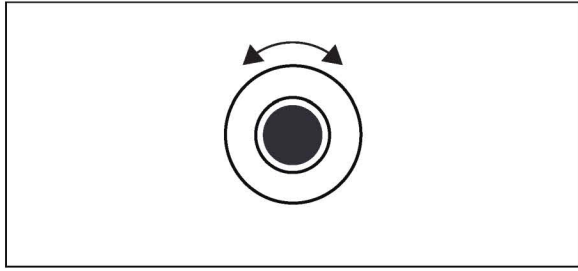

rotate the dark gray knob to adjust the speed of the arpeggio.

pattern

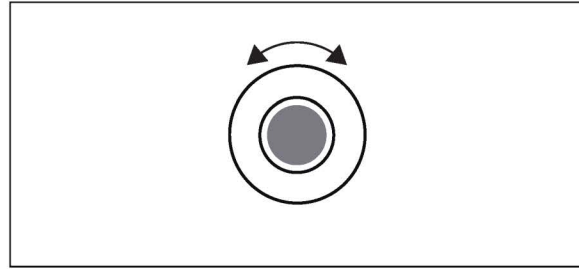

rotate the mid gray knob to adjust the pattern style.

patterns include:

- up
- down
- up/down
- up/repeat/down
- random
- play order

range

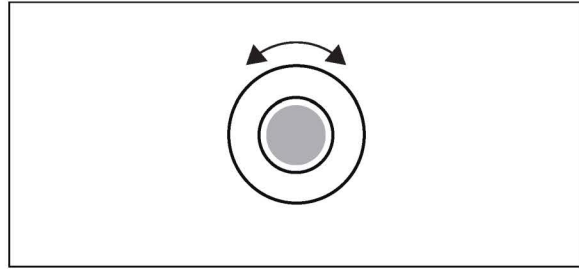

rotate the light gray knob to change the range of the arpeggio. this allows you to arpeggiate across multiple octaves.

hold

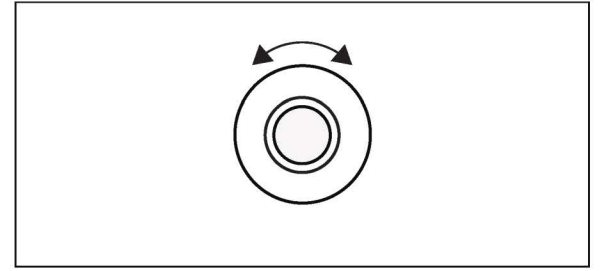

rotate the white knob to enable and disable hold, this will hold the arpeggio without you having to keep the notes held.

note length

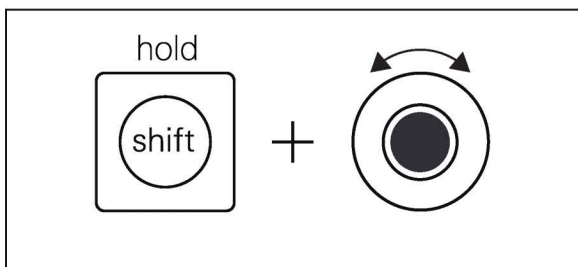

hold shift and rotate the dark gray knob to adjust the note length.

style

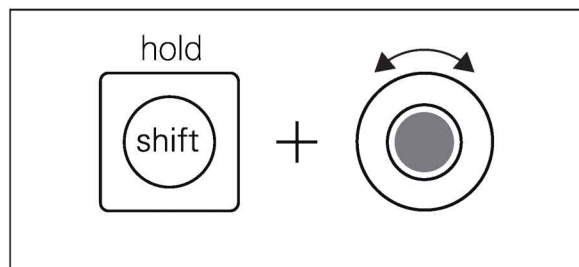

hold shift and rotate the mid gray knob to change the arpeggio style, this will change the order in which the notes are played back.

glide

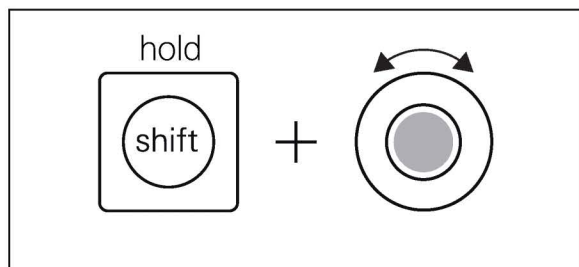

hold shift and rotate the light gray knob to adjust the glide between notes.

stereo

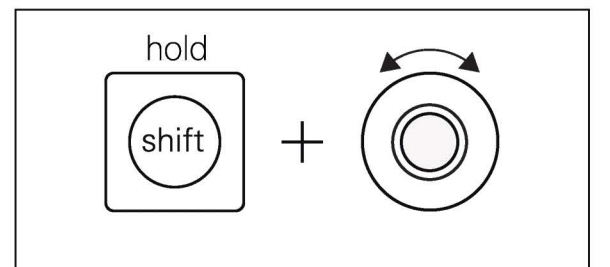

hold shift and rotate the white knob to adjust the stereo amount, this will pan each note by a specified amount.

9.2 maestro

record notes

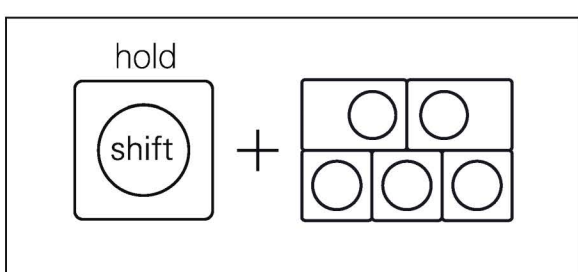

hold shift and play notes on the musical keyboard to record them to maestro. maestro will then play them back whenever you press a key, transposing the notes up or down. use maestro to record and play chords.

roll

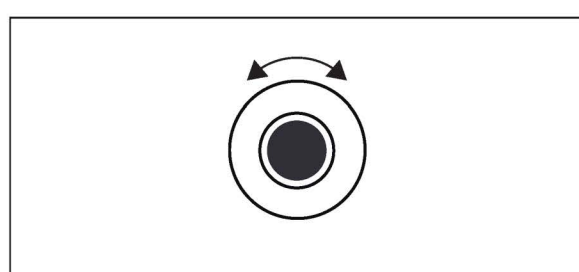

rotate the dark gray knob to adjust the roll of the notes, this will strum the notes faster or slower.

pattern

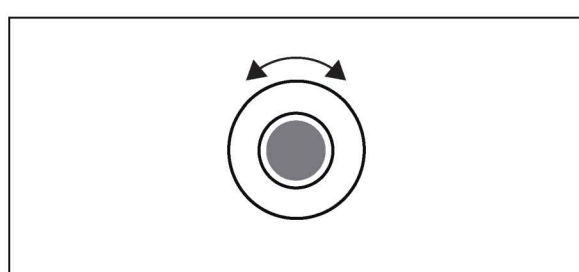

rotate the mid gray knob to adjust the pattern style.

patterns include:

- up
- down
- up/down
- random

hold

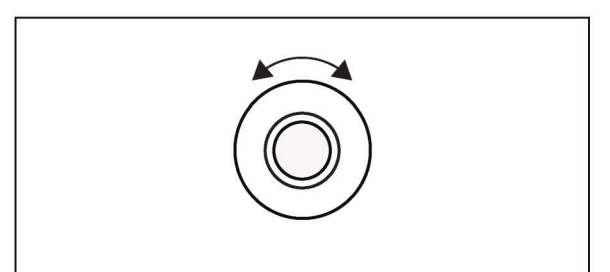

rotate the white knob to enable and disable hold, this will hold the maestro chord without you having to keep the note held.

9.3 hold

hold will hold whatever notes you play, until the next note is played. great for basses, perfect for chords. enable it and play some notes to have them hold. to turn off all notes, either press stop or disable it by pressing the player button.

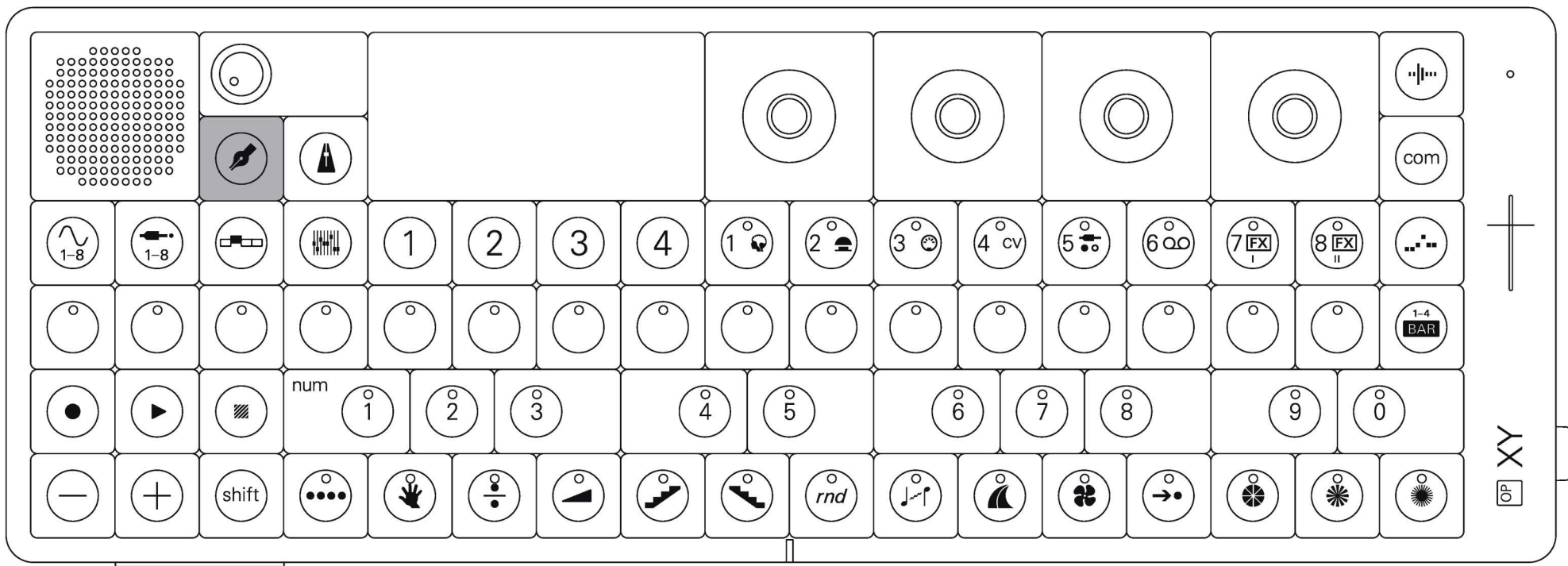

use projects to create full tracks or even just musical sketches.

OP-XY can store thousands of projects. each project has a history folder that allows you to go back in time and hear past versions of your project.

enter project view

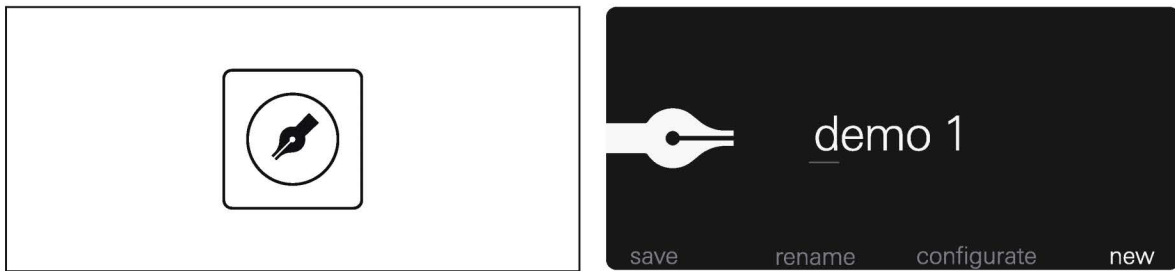

press project to enter the project view.

10.1 rename, save, create and configure

new

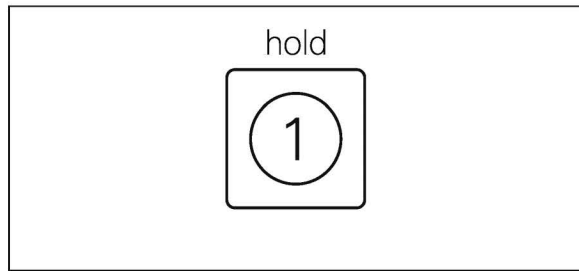

hold M1 to create a new project, this will automatically save your project, as long as you have auto save enabled in the project or system settings.

save

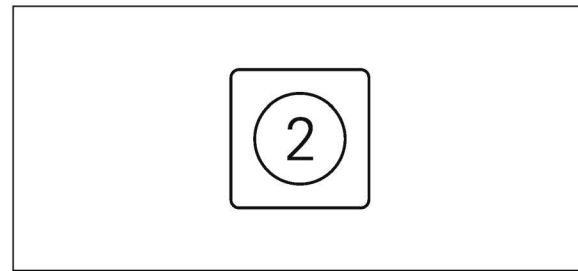

press M2 to save your project and create a version in the version folder. by default OP-XY will auto save, however you can disable this in project and [system settings](#) to only manually save instead.

rename

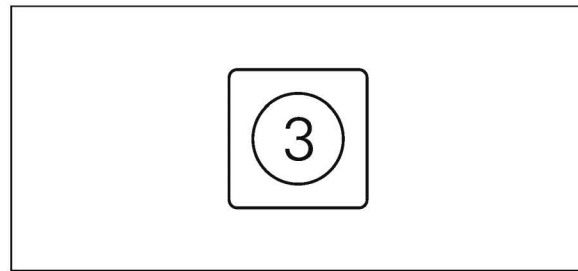

press M3 to rename your project. you can then use the dark gray encoder to select the character, mid gray to edit it and then use the module keys to confirm, navigate, cancel or delete.

configure

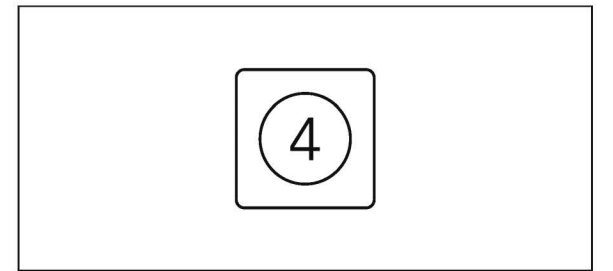

press M4 to configure your project's settings. these are separate from the system settings and allow you to configure everything from time signatures to midi channels.

10.2 projects folder

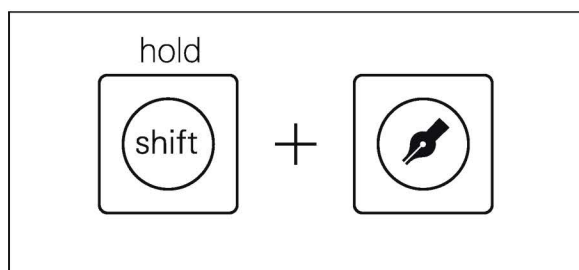

hold shift and press project to open the projects folder.



load

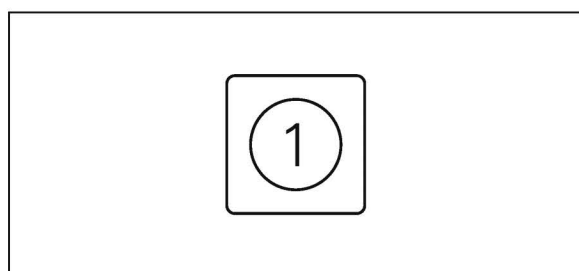

press M1 to load the selected project

history

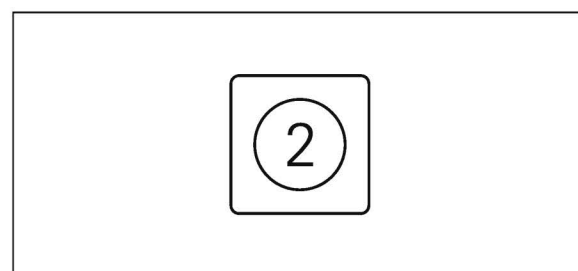

press M2 to view the history of the selected project. as you work on your project and press save, each save and auto save will be stored in the history folder so you can go back in time and hear old versions of your project.

duplicate

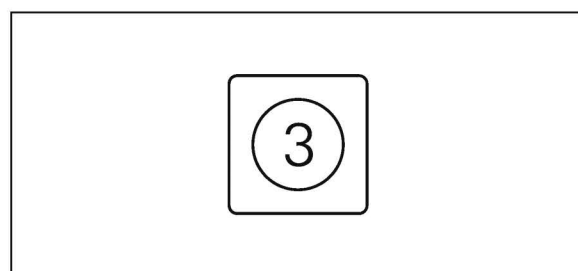

press M2 to duplicate your project. this will duplicate all patterns, scenes, tracks and everything else held in the project.

delete

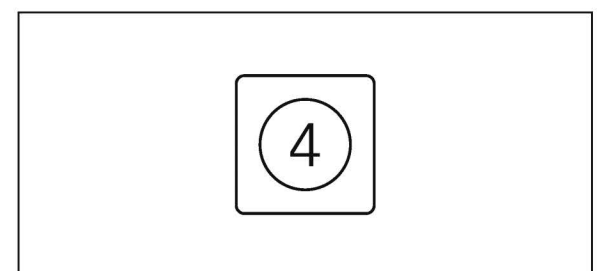

press M4 to delete the selected project.

10.3 project settings

config

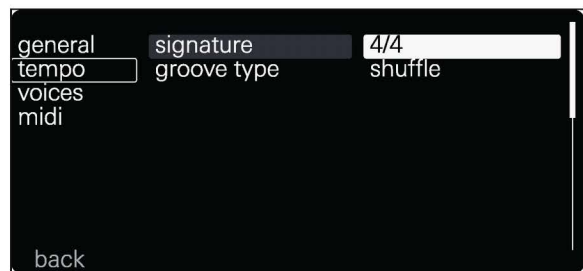

entering the config page under the project view will take you to the project settings.

type

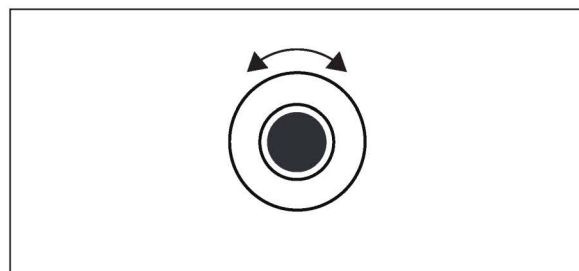

rotate the dark gray knob to select between general, tempo, voices and midi project settings.

setting

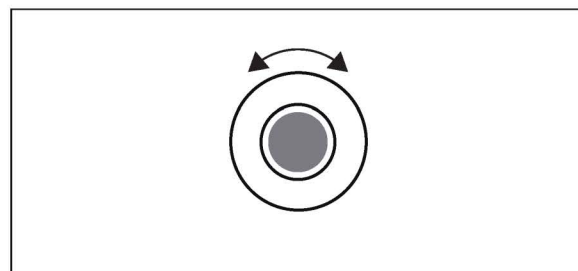

rotate the mid gray knob to choose the setting you wish to edit.

value

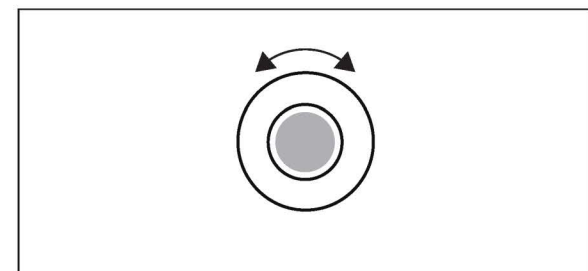

rotate the light gray or white knob to adjust the value on the selected setting.

general

the general settings page in project settings allows you to transpose every note in your project, including drums.

perfect for matching the key of you track on OP–XY with something else.

tempo

the tempo settings page in project settings allows you to edit the time signature between

3/4, 4/4, 5/4, 6/8, 7/8 and 12/8 as well as view and edit the groove type.

voices

the voices settings page in project settings allows you to assign voices to specific tracks.

OP–XY has 24 voices of polyphony and by default automatically assigns voices but you can give tracks specific voice priority by assigning the voices on a track.

midi

the midi settings page in project settings allows you to set the midi channel on each of the 16 tracks.

perfect for connecting external midi devices and sequencing them with OP–XY.

exit

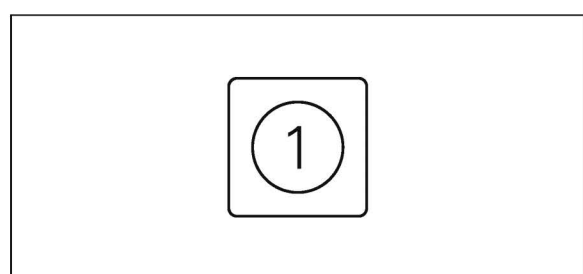

press M1 to exit project settings.

11. tempo

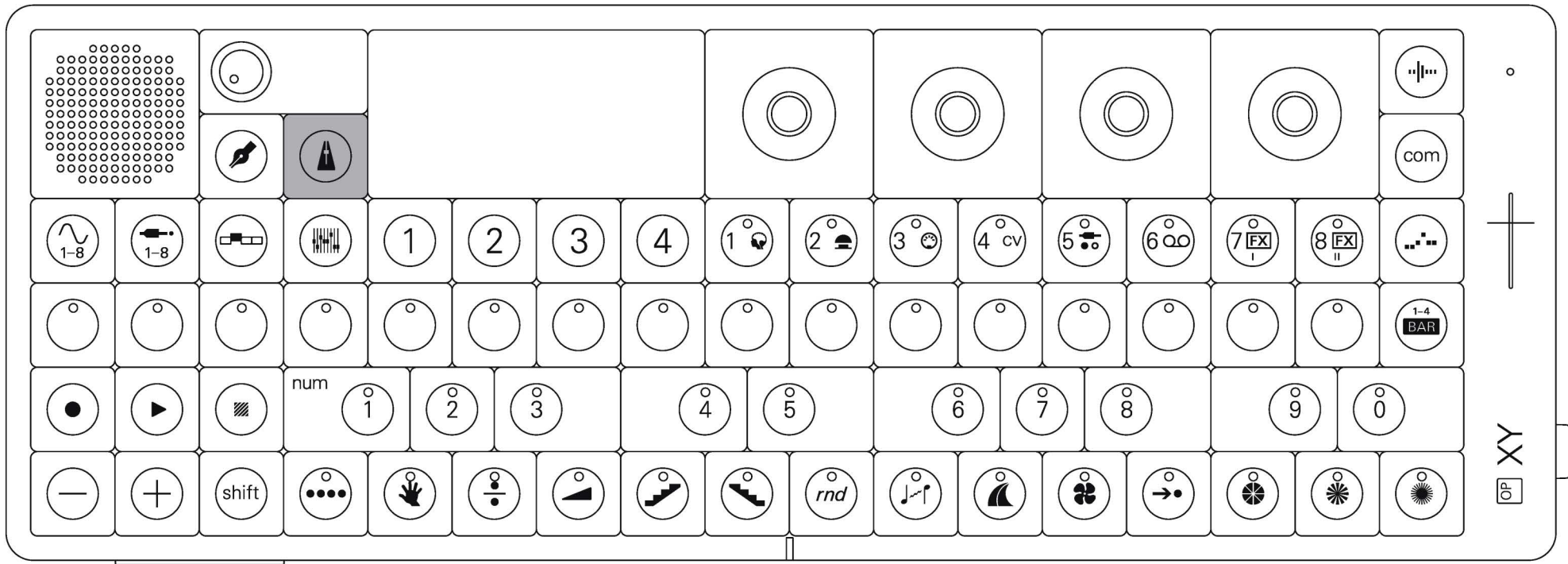

use tempo to adjust tempo, swing and metronome.

enter tempo

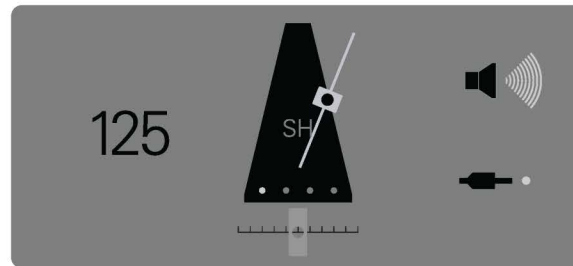
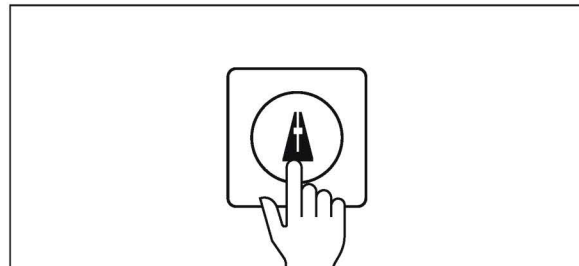
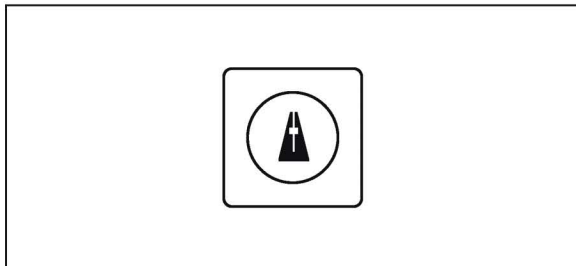

in any screen on the device, press tempo to view the tempo screen.

tap tempo repeatedly to tap the tempo.

11.1 edit tempo

tempo

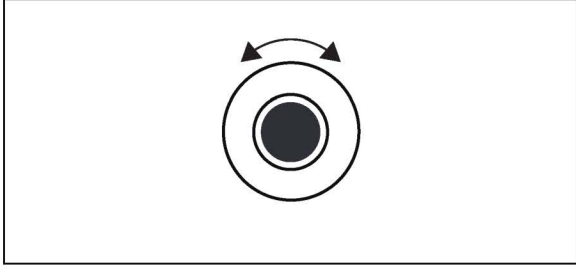

rotate the dark gray knob to adjust the tempo of your song.

groove type

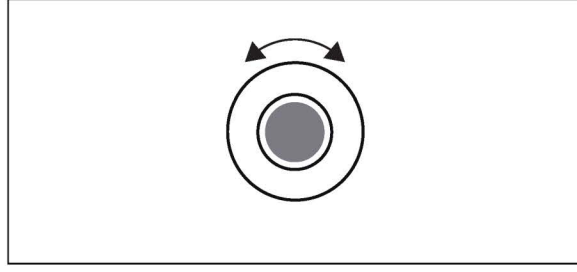

rotate the mid gray knob to adjust the groove style.

groove amount

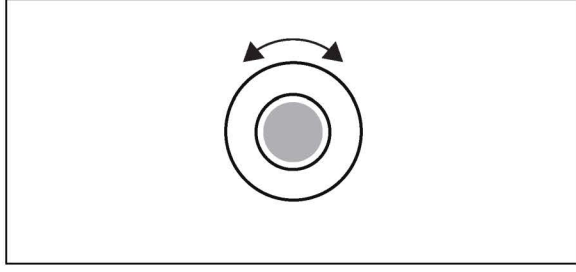

rotate the light gray knob clockwise past the center line to adjust the amount of groove.

metronome

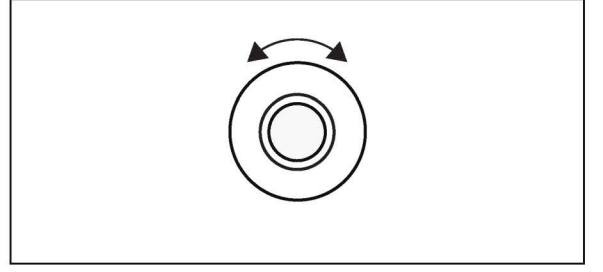

rotate the white knob to adjust the volume of the metronome. click it to enable and disable it.

11.2 what are grooves?

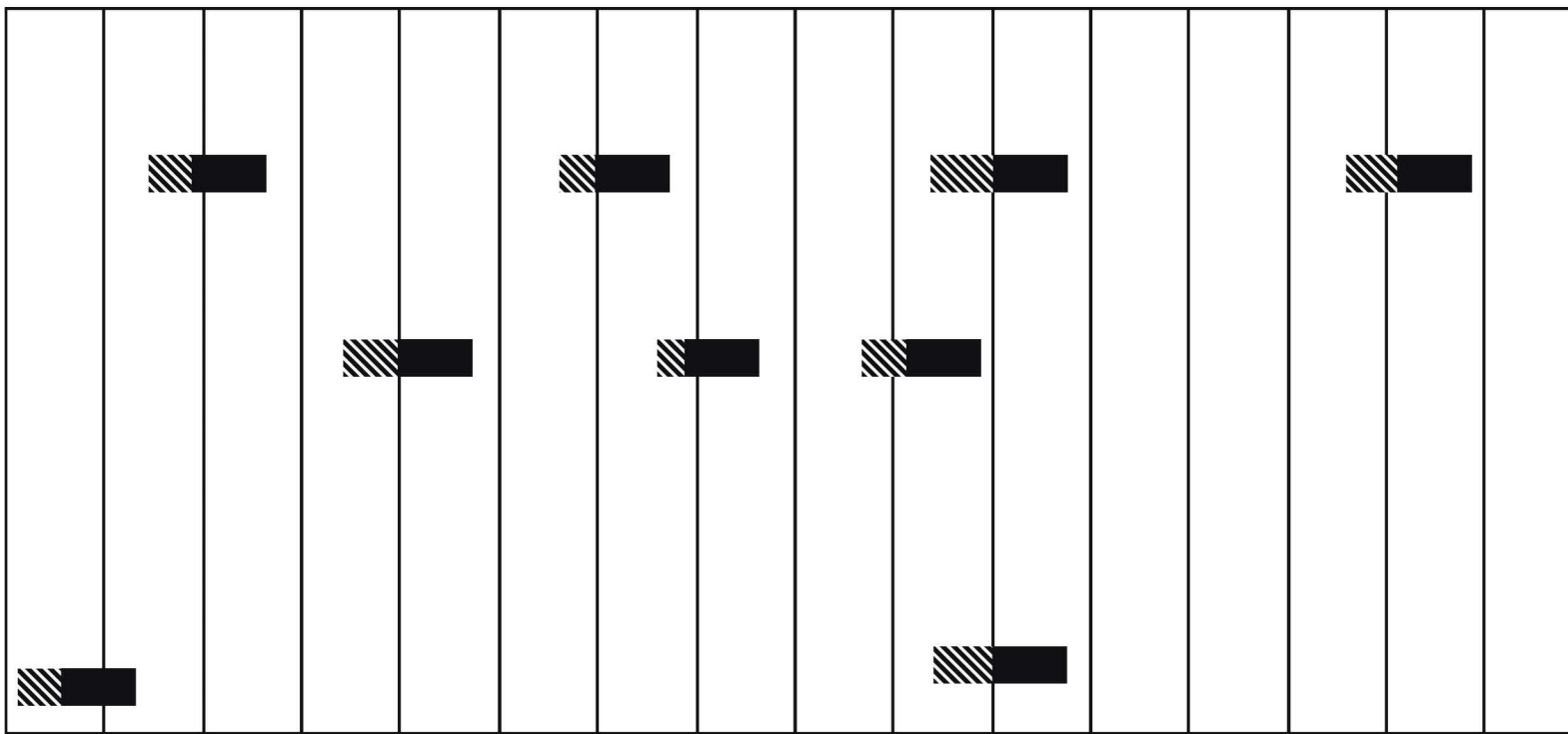

grooves allow you to change feel of your sequences, adding swing and shuffle to notes. grooves change the timing of notes recorded in the sequencer, as well as the velocity of those notes.

grooves apply a slight randomisation to both the timing and velocity of notes to make the swing sound more human.

shuffle

your bread and butter groove, use shuffle to add the perfect swing to your beat.

half shuffle

a margarine equivalent of shuffle, half shuffle offers a diet friendly alternative to shuffle.

danish

chill out, have a beer, sit on the grass, let your beat get a little more danish.

bombora

let the waves flow, pushing your beat up against the sea floor, breaking up your twos and fours.

wobbly

woah, what the hell did i just press?! oh wait, thats the wobbly groove. use it mess up your beat and get far too funky.

gaussian

durch planmässiges tattonieren you can create awesome music, awesome maths too.

accents

emphasise the most important beats with accents.

island nod

careful of your neck when you use this one, you may find yourself using it excessively.

disfunk

disfunk combines disco and funk, turn it up to get funky or turn it down to get groovy.

roll over

slow things down then roll over, tuck yourself into bed and make some sweet hiphop beats.

prophetic

nobody knows quite where this one came from, but it sounded cool so we kept it.

12. workflow

there are many workflows for music creation on OP–XY. this chapter will cover some best practices to get the most out of your OP–XY.

project overview

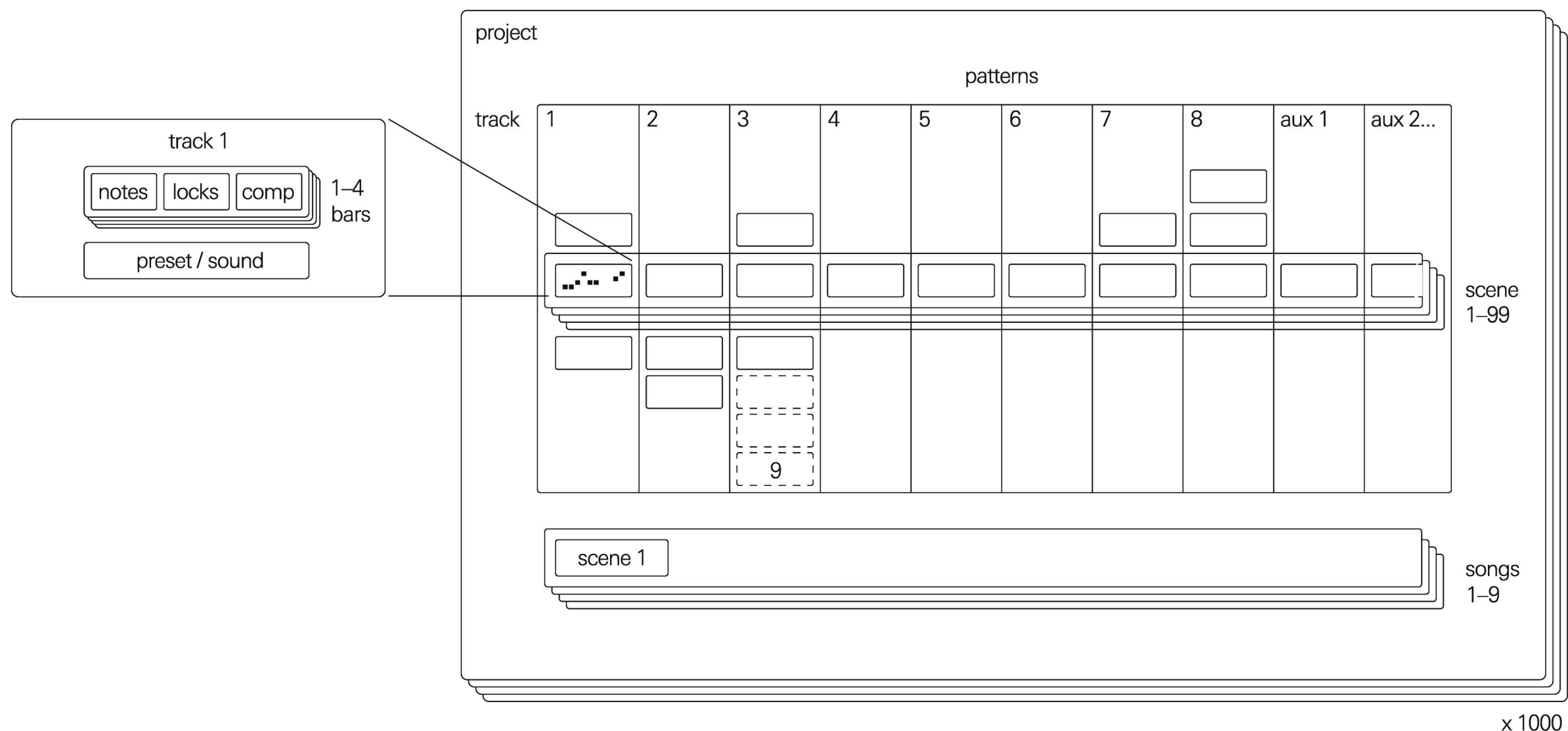

12.1 patterns, scenes, songs and projects

each track (both instrument and auxiliary) holds up to nine patterns. a pattern is an arrangement of notes or sounds. each pattern holds a maximum of 120 notes.

the arrangement of patterns on every track is saved as a scene. there are 99 available scene with each scene storing the pattern on each track as well as the track volumes and mutes.

scenes can then be composed into songs. songs are arrangements of scenes. OP–XY can store 9 songs. scenes are as long as their longest pattern.

projects are where you create patterns, scenes and songs. projects can be quick musical ideas or full songs. OP–XY can store thousands of projects.

12.2 creating a song

to create a song, start by sequencing the various tracks.

use arrange to create new patterns or copy and modify existing patterns.

switch between the scenes and compose patterns into the sections of your song.

once you have a few scenes you are happy with, you can start to arrange these into a song. open the song mode and sequence the scenes into a full song.

12.3 the importance of saving

as OP–XY does not autosave, it is important that once you are happy with your project that you press the save button in the project screen.

in case you forget to save, OP–XY has a special backup folder within the projects folder. use it only when absolutely necessary.

saving regularly is not only good practice but also allows you to “turn back time” and listen to older versions of your project within the history folder.

14. instrument

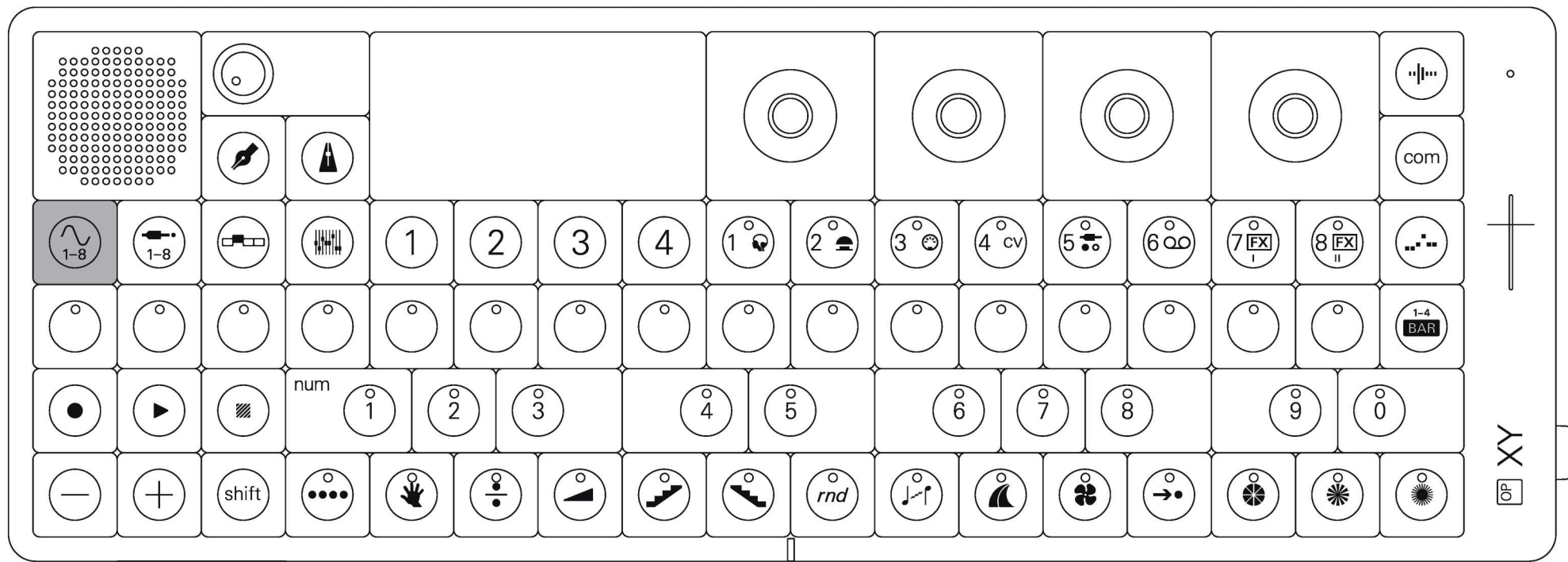

instrument mode holds 8 instrument tracks. an instrument can either be a sampler or a built-in synth engine, each with its own characteristics.

select a track by pressing the 1-8 keys, to change the instrument assigned to a track, press shift and M1. to select a sample pack or synth engine or to change the preset on that track, hold shift and press the track button you wish to replace.

enter instrument mode

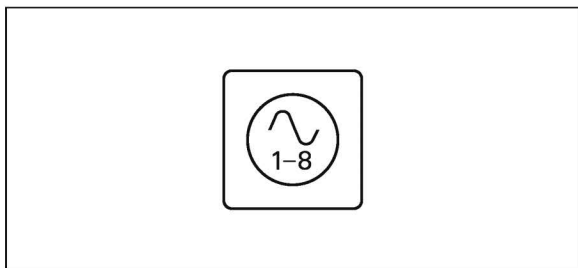

press instrument to open instrument mode.

14.1 engine

the engine is where sound is generated, the source of audio, noise or any musical tones.

engine

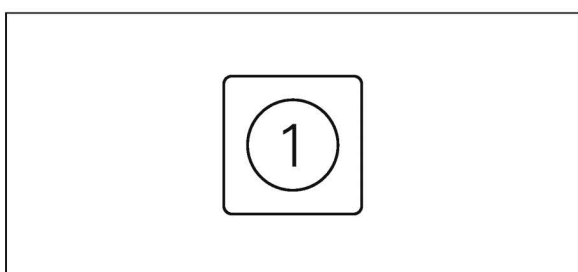

M1 is where you will find the synth, drum or sampler.

change engine

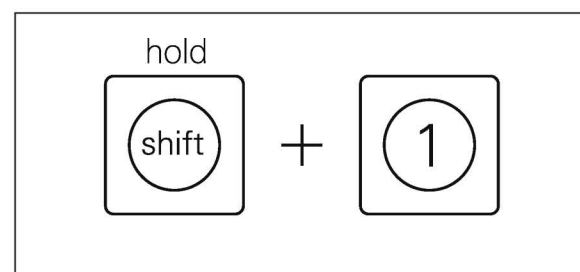

hold shift and press M1 to select the engine on the current track

edit

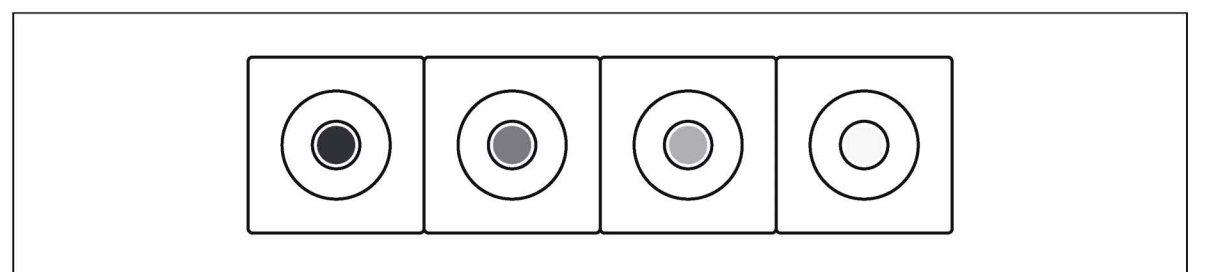

when in M1, the encoders will control the various synth engine, sampler or drum parameters

a full list of what the parameters control can be found in the [engine chapter](#).

14.2 envelopes

the envelopes allow you to shape your sound, how it fades in, sustains and fades out.

envelopes

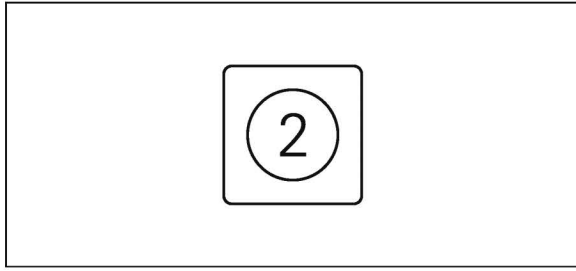

M2 holds the envelopes. OP-XY features two envelopes per track, one amplitude envelope and one filter envelope.

switch envelopes

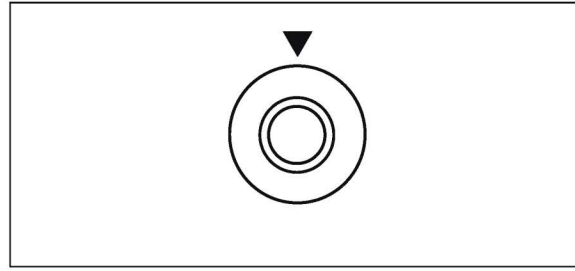

click on an encoder to switch between amplitude and filter envelopes. this applies to both drum and synth type tracks.

edit envelopes

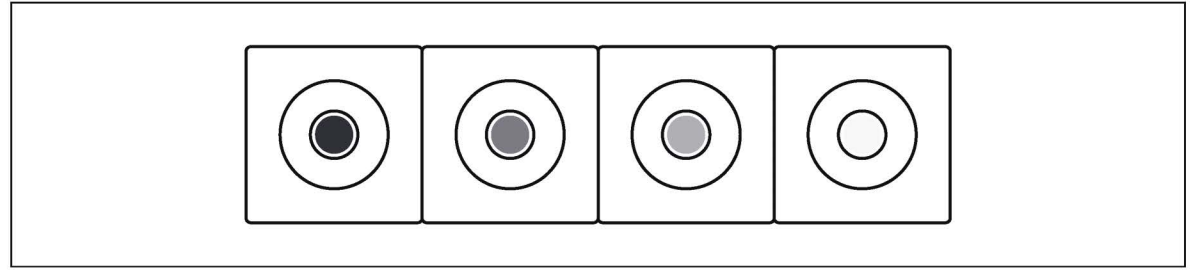

while in the envelopes page, rotate the encoders to adjust the following:

- dark gray - attack
- mid gray - decay
- light gray - sustain
- white - release

play mode

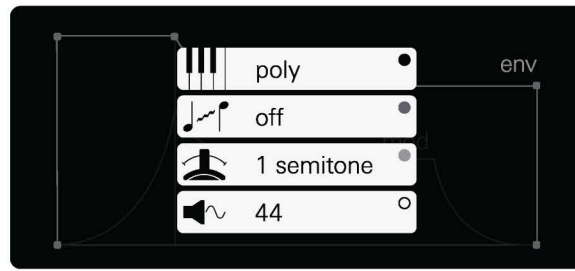
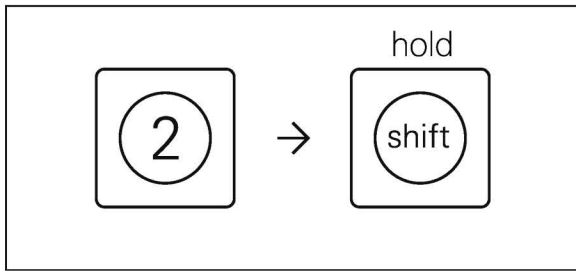

hold shift while in M2 to modify the play mode.

play mode

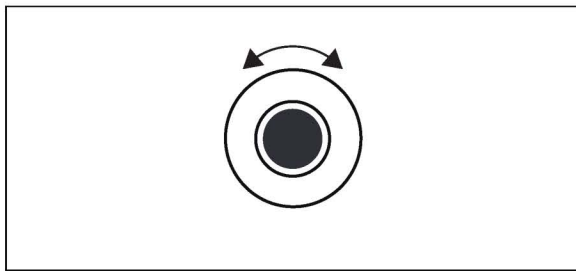

rotate the dark gray knob to select between poly, mono, legato and unison. this changes both how the notes play and how many you can play at the same time.

portamento

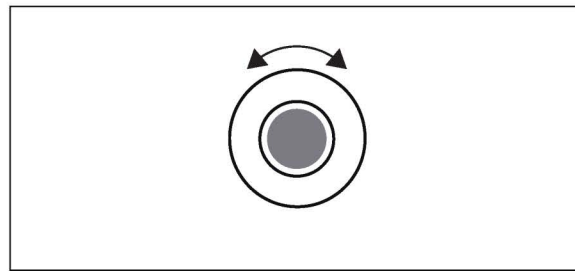

rotate the mid gray knob to adjust portamento amount, this is the time it takes to glide between notes.

bend range

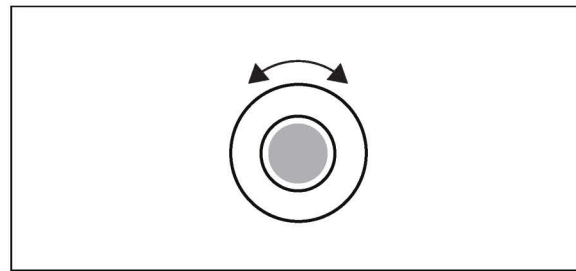

rotate the light grey knob to adjust the bend range, this is the pitch range of the pitch bend.

preset volume

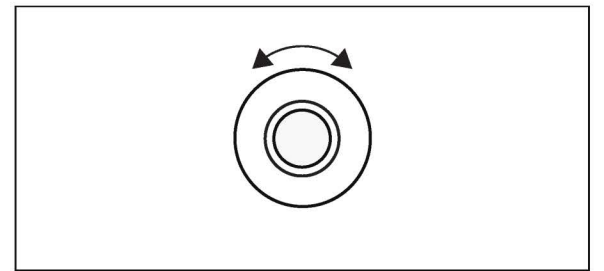

rotate the white knob to adjust the preset volume, this is separate from the track volume and allows you to ensure your presets have a consistent volume.

14.3 filter

the filter allows you to remove frequencies and make others more pronounced.

filter

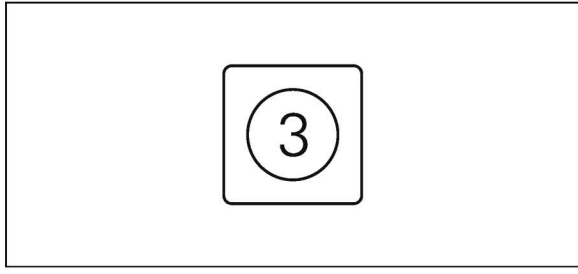

M3 is where you can find the filter. OP-XY features a range of different filters to choose from which will each impart a unique sound on your instrument.

change filter

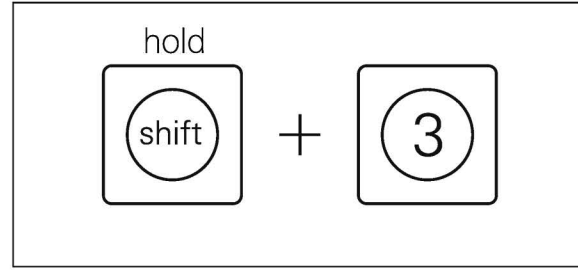

holding shift and pressing M3 will allow you to change the filter type. OP-XY features several filters, each with their own character.

cutoff

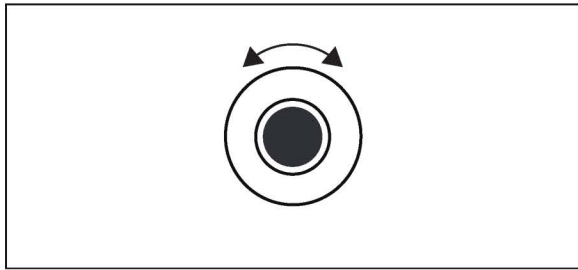

rotating the dark gray knob will adjust the filter cutoff. this is the frequency before or after which the filter will take effect.

resonance

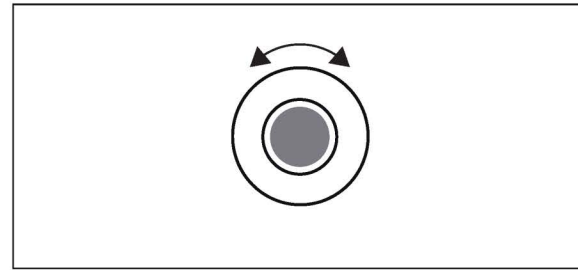

rotating the mid gray knob will adjust the resonance, this is a volume boost at the cutoff frequency and can be used to accentuate the effect of the filter.

envelope amount

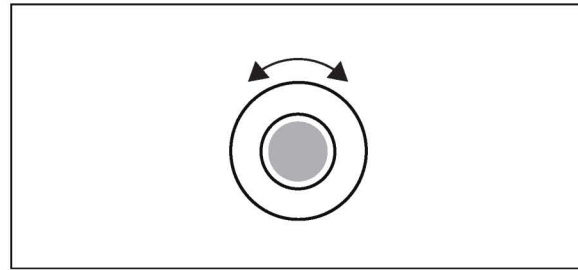

rotating the light gray knob will adjust the envelope amount, this is how much the filter envelope on M2 will move the filter.

key tracking

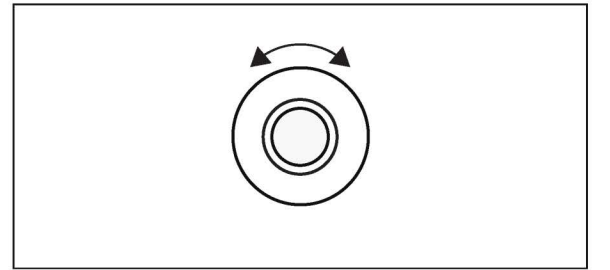

rotating the white knob will adjust the key tracking on the filter, opening or closing the filter depending on the pitch of the note played.

track send

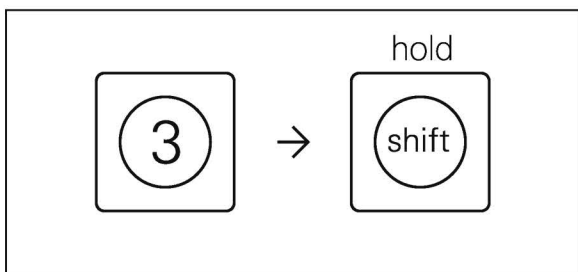

hold shift while in M3 to modify the play mode.

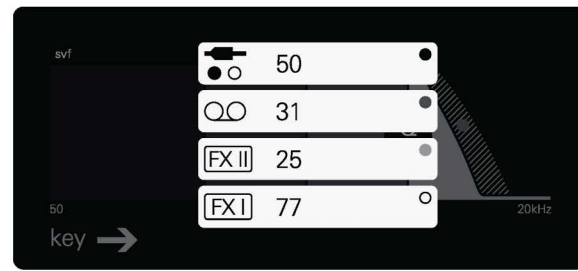

aux out

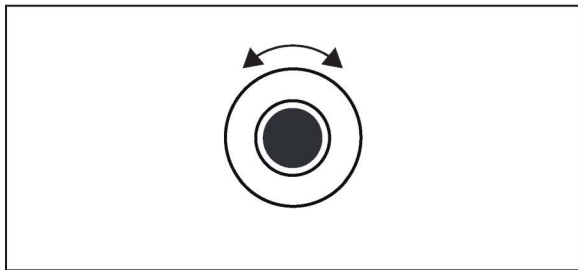

rotate the dark gray knob increase the aux out send.

tape

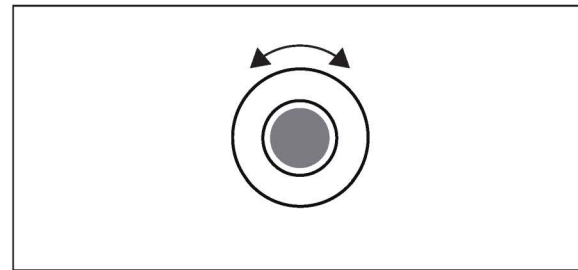

rotate the mid gray knob to increase the tape send.

fx i

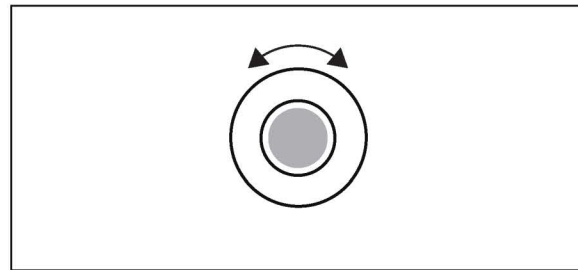

rotate the light gray knob to increase the fx i send.

fx ii

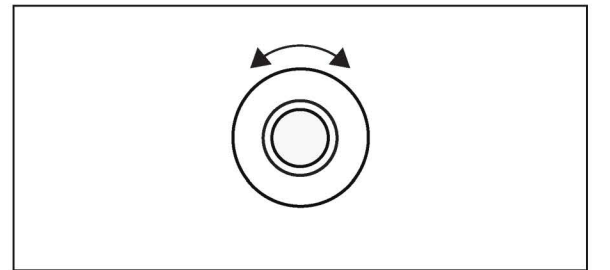

rotate the white knob to increase the fx ii send.

lfos allow you to make more complex sounds through the process of modulation.

lfo

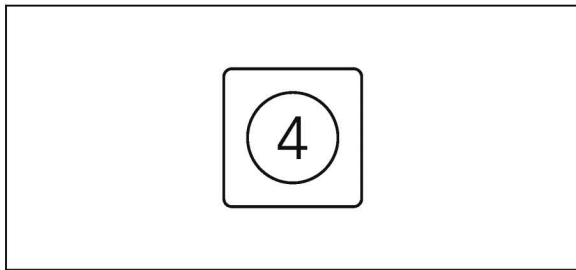

M4 holds the lfo. lfos allow you to add hands-free modulation to your tracks. you can choose from several lfos which will each impart a different effect on the desire track.

source/rate

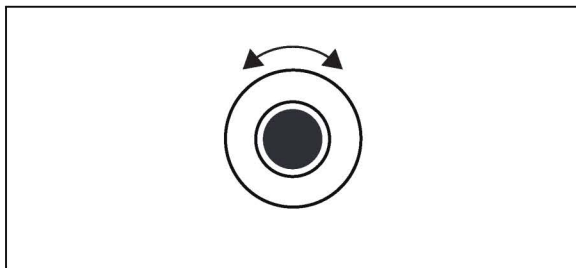

rotating the dark gray knob will adjust the source or rate of the lfo. clicking it in some lfos will adjust the shape.

amount

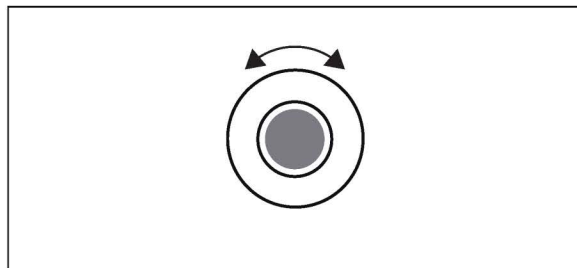

rotating the mid gray knob will adjust the amount that the lfo affects the destination parameter.

destination

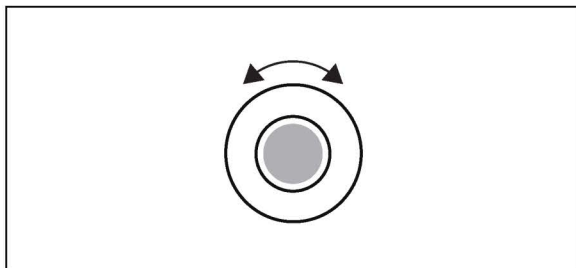

rotating the light gray knob will select the destination on the track, this is the module that you wish to assign the lfo to.

parameter

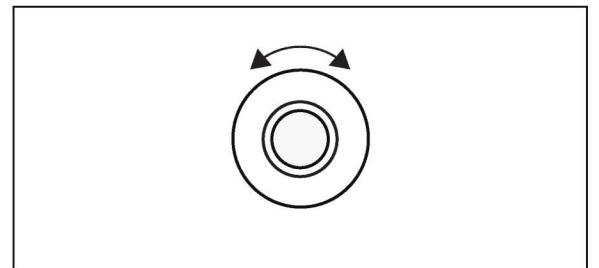

rotating or pressing down the white knob will select the parameter you wish to modulate, this is the encoder on the destination module that you wish to modulate.

change lfo

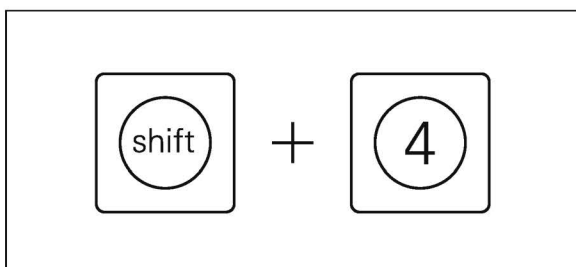

press shift and M4 in combination to change the lfo type. there are four lfo types available on OP-XY: element, random, tremolo and value.

sub functions

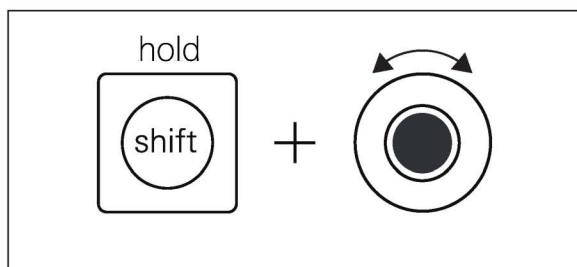

some lfos feature sub functions—you can edit these by clicking the encoders or alternatively holding shift and rotating the encoders.

element

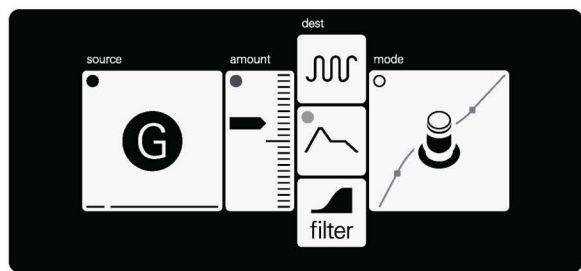

element uses the built-in gyroscope and microphone, as well as the envelope and a combination of all three to use as a modulation source.

source

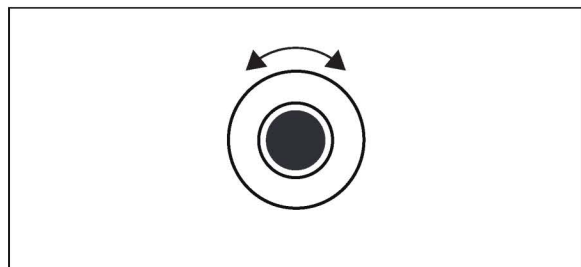

rotating the dark gray knob will adjust the source of the element lfo. available sources are:
 gyroscope
 built-in microphone
 amp envelope
 sum (all of those combined)

amount

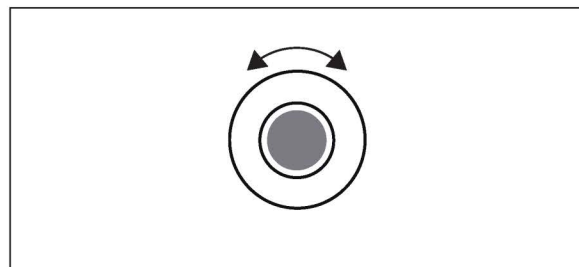

rotating the mid gray knob will adjust the amount that the lfo affects the destination parameter.

destination

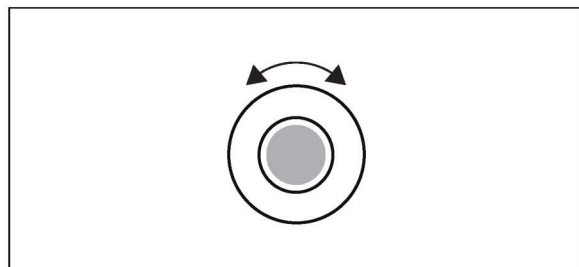

rotating the light gray knob will select the destination on the track, this is the module that you wish to assign the lfo to.

parameter

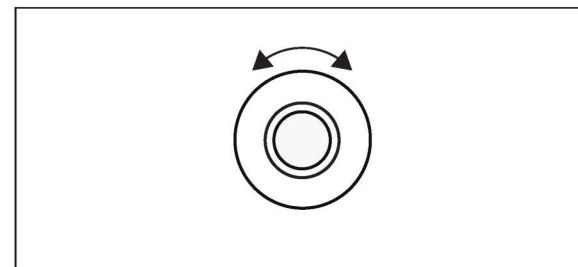

rotating or pressing down the white knob will select the parameter you wish to modulate, this is the encoder on the destination module that you wish to modulate.

random

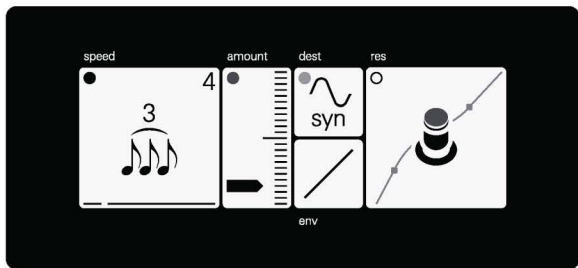

random uses a random value generator as a modulation source.

speed

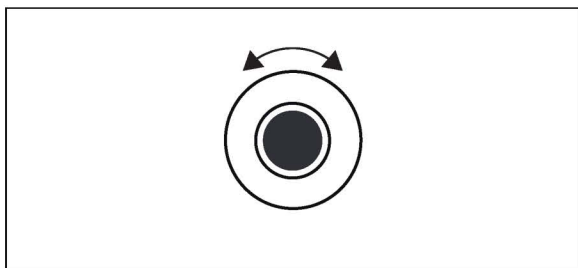

rotating the dark gray knob will adjust the speed of the random lfo. turning it anti-clockwise will allow you to tempo sync the speed and rotating it clockwise until the dial is shown will allow a continuous speed change.

amount

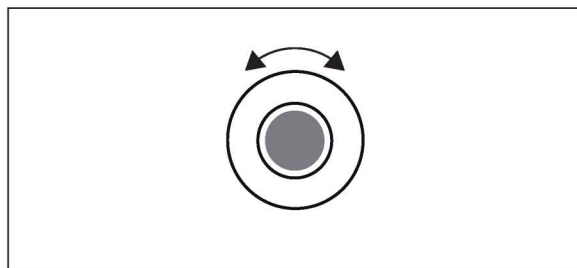

rotating the mid gray knob will adjust the amount that the lfo affects the destination parameter.

destination

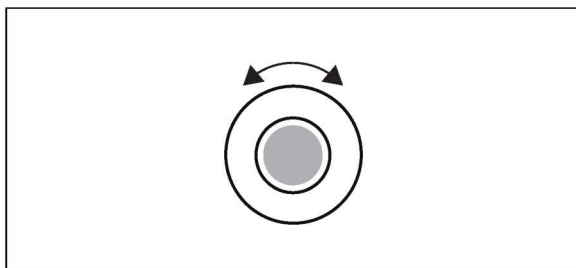

rotating the light gray knob will select the destination on the track, this is the module that you wish to assign the lfo to. each module has a regular and 'free' destination, when set to the free destination, the value does not reset when a key is pressed, instead continuously modulating the parameter.

parameter

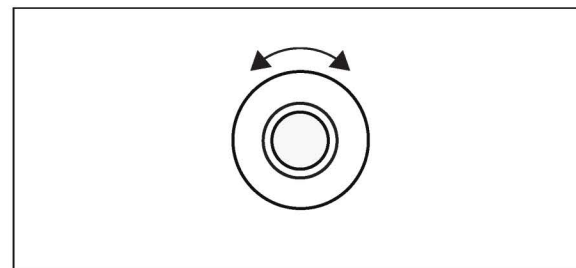

rotating or pressing down the white knob will select the parameter you wish to modulate, this is the encoder on the destination module that you wish to modulate.

envelope

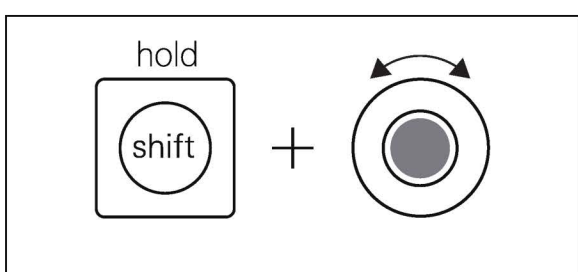

holding shift while rotating the mid gray knob will adjust the envelope of the random lfo, allowing you to slowly fade the modulation in or out.

tremolo

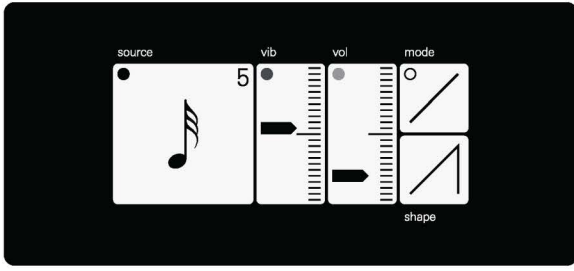

tremolo is great for adding subtle or dramatic variations to the volume and pitch of a track.

speed

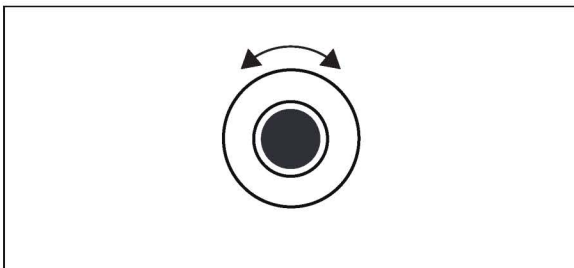

rotating the dark gray knob will adjust the speed of the tremolo lfo. turning it anti-clockwise will allow you to tempo sync the speed and rotating it clockwise until the dial is shown will allow a continuous speed change.

amount

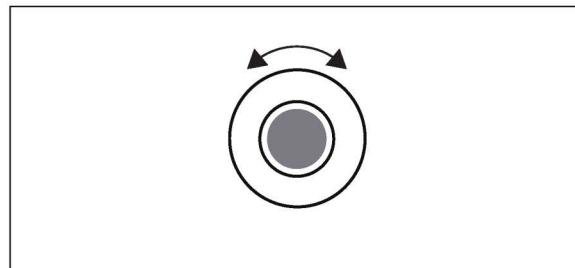

rotating the mid gray knob will adjust the amount that the lfo affects the vibrato. this modulates the pitch of the sound.

destination

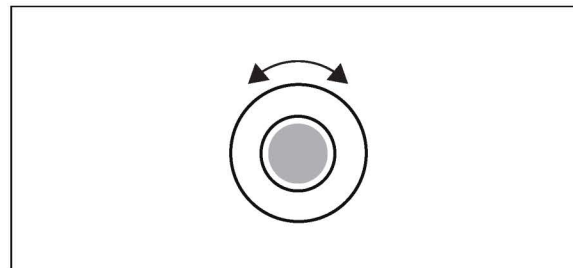

rotating the light gray knob will adjust the amount that the lfo affects the volume. this modulates the volume of the sound, creating a tremolo effect.

envelope

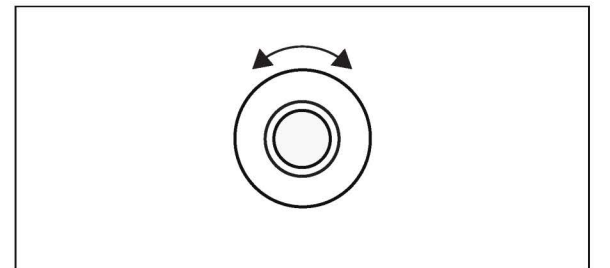

rotating the white knob will adjust the envelope of the tremolo lfo, allowing you to slowly fade the modulation in or out.

shape

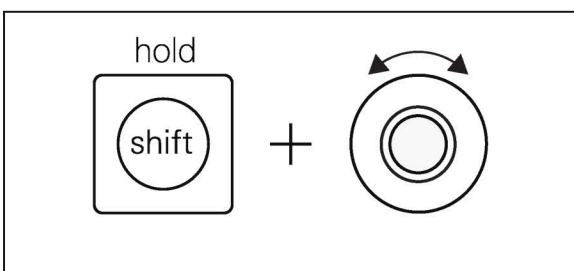

holding shift while rotating the white knob or pressing it down will change the shape of the tremolo.

value

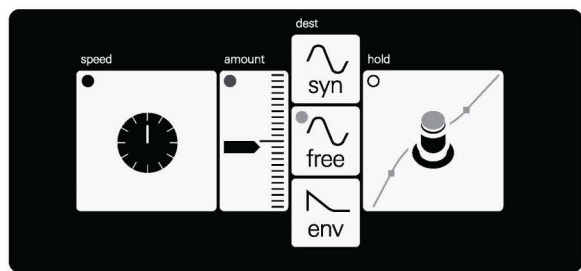

value uses a continuous or triggered low frequency oscillator to modulate a chosen parameter.

speed

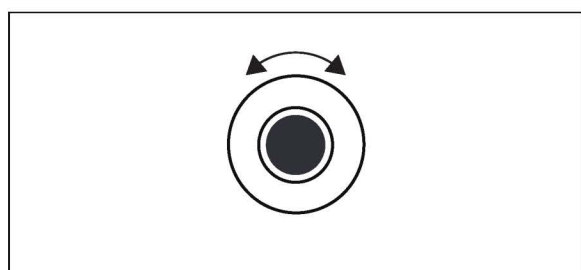

rotating the dark gray knob will adjust the speed of the value lfo. turning it anti-clockwise will allow you to tempo sync the speed and rotating it clockwise until the dial is shown will allow a continuous speed change.

amount

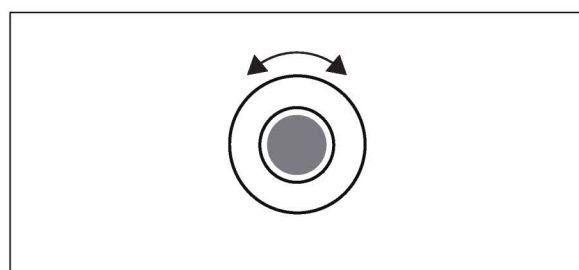

rotating the mid gray knob will adjust the amount that the lfo affects the destination parameter.

destination

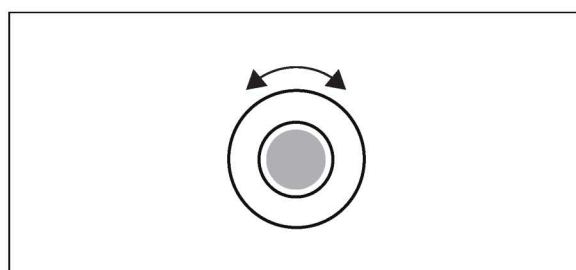

rotating the light gray knob will select the destination on the track, this is the module that you wish to assign the lfo to. each module has a regular and 'free' destination, when set to the free destination, the value does not reset when a key is pressed, instead continuously modulating the parameter.

parameter

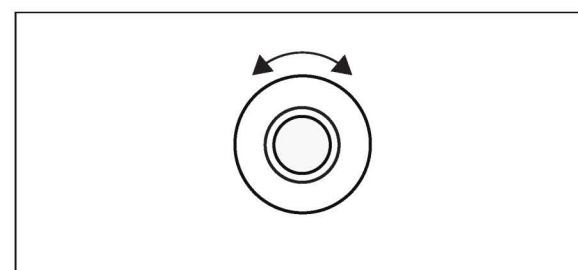

rotating or pressing down the white knob will select the parameter you wish to modulate, this is the encoder on the destination module that you wish to modulate.

14.5 preset settings

preset settings allow you to adjust everything from tuning to modulation targets. use the color coded encoders to adjust the various settings.

once you are happy with your settings press any of the module buttons (M1-M4) or the instrument button to return to the the instrument pages.

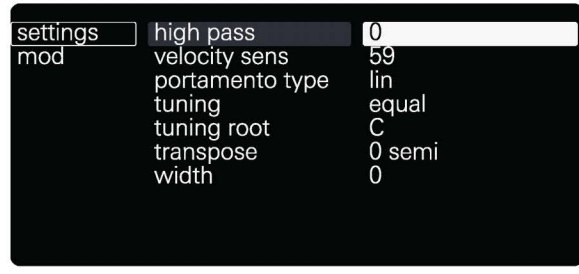
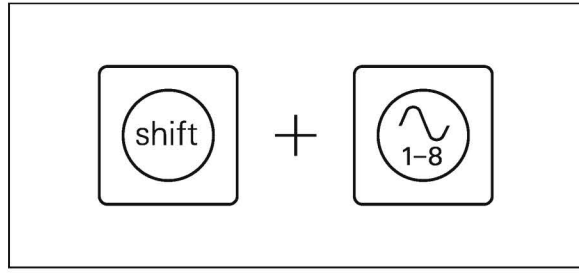

press shift and instrument to enter the preset settings.

settings/mod

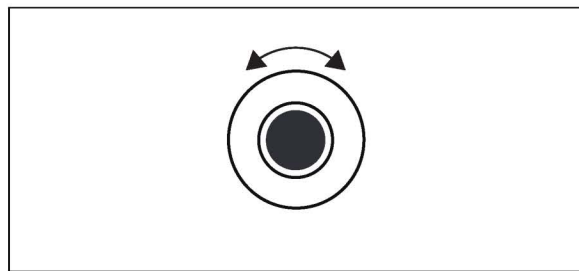

rotate the dark gray knob to select between settings and modulation.

setting

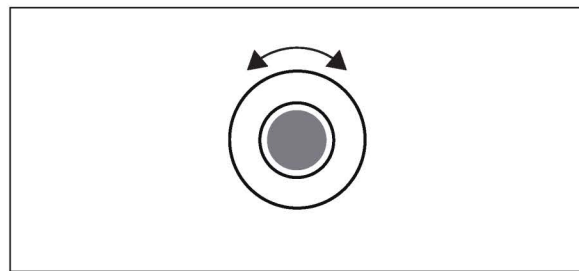

rotate the mid gray knob to select the setting you wish to edit

value

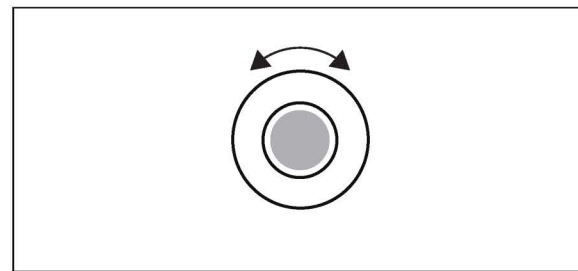

rotate the light gray or white knob to edit the value on the selected setting.

settings

the settings tab holds settings for tuning, allowing for microtonal adjustments and transposition, you can create up to 11 user tunings, where you can set the pitch of each note.

here you can also add a basic high pass to the track for filtering out low frequencies, control velocity sensitivity, adjust the style of portamento and increase the width of your preset, spreading the sound.

mod

in the mod settings you can change the routing of the modwheel, aftertouch, pitchbend and velocity to control various synth parameters.

tuning

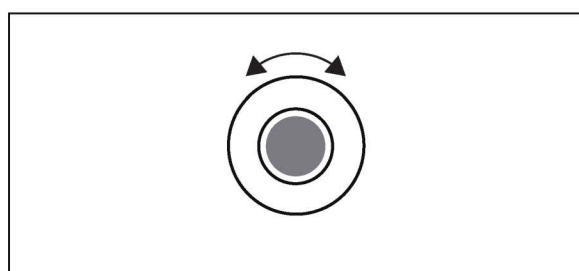

to create your own tuning, open the preset settings then go to settings, then tuning.

select tuning

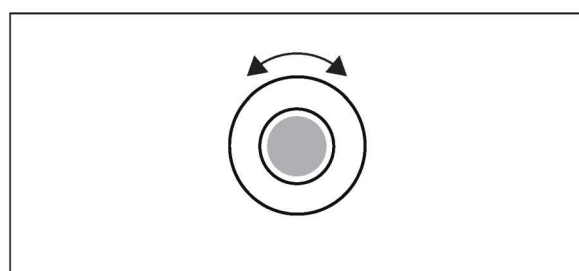

use the light grey knob to select one of the user tuning slots.

edit

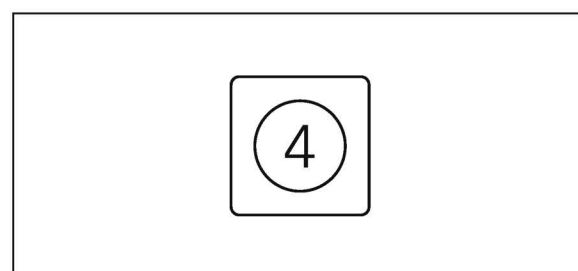

press M4 to edit the user tuning slot.

set notes

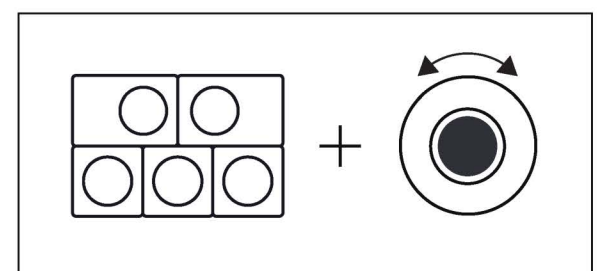

select the note you wish to edit by playing it on the musical keyboard and then rotate the dark gray knob to adjust the tuning in cents and the mid gray knob to adjust the tuning in microcents.

14.6 view and create presets

OP-XY comes with presets for every engine and category of sound. these allow you to quickly get up and running with the sound you want.

you can of course create your own presets to lend the device a unique and personal sound.

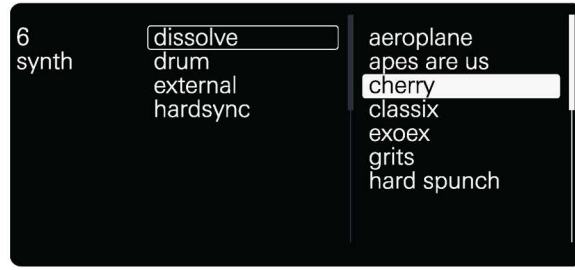
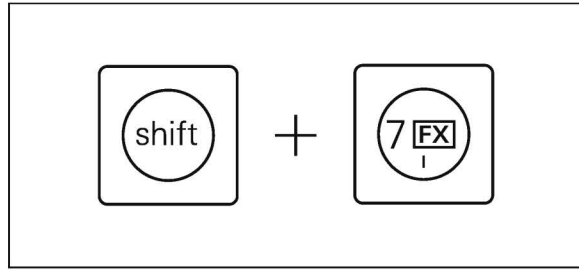

press shift and any track button while in instrument mode to view and change the preset on that track.

category/engine

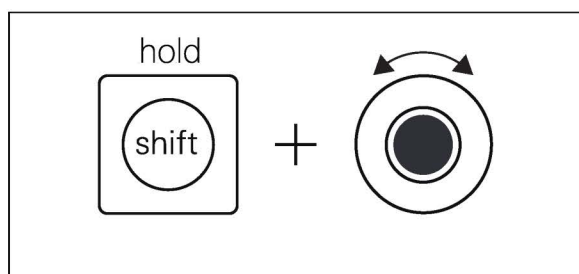

hold shift and rotate the dark gray knob to switch between category view and engine view.

type

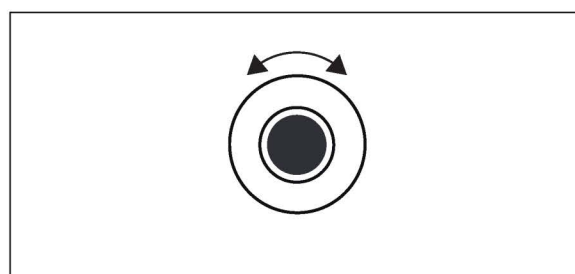

rotate the dark gray knob to select the category or engine you wish to choose from.

preset

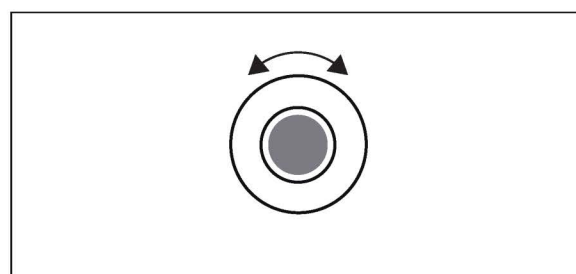

rotate the mid gray, light grey or white knob to select the preset within that category.

select

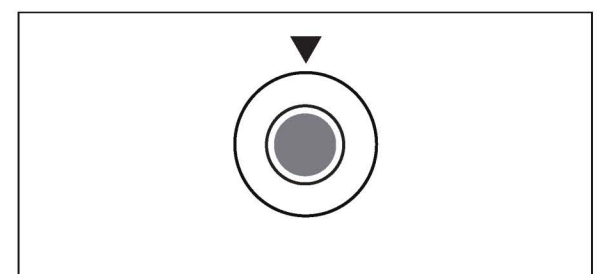

click any encoder to select the preset.

rename preset

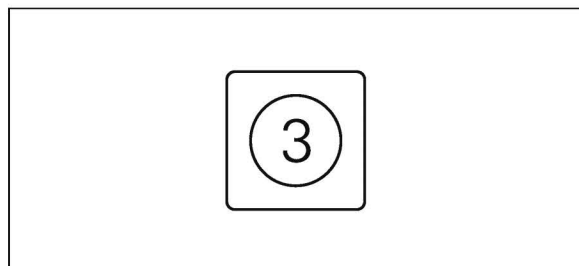

select a user preset and press M3 to rename it. use the dark grey knob to select a character and the other knobs to edit it. confirm with M1, next character with M2, cancel with M3 and delete with M4.

delete preset

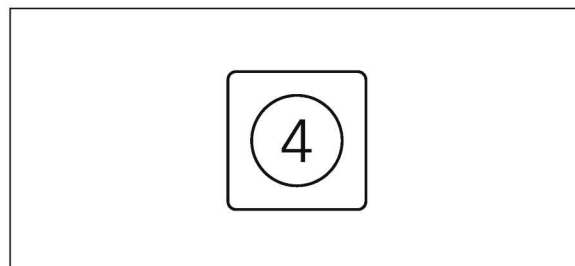

select a user preset and press M4 to delete it.

scramble

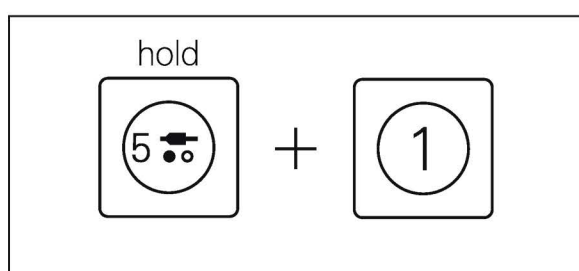

if you want to mess up a sound, or flick through some random sounds then hold a track button and press M1 to scramble that track.

copy preset

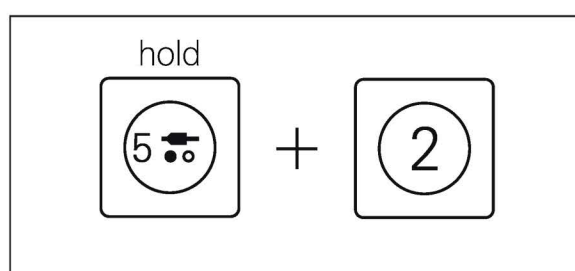

to copy a sound from one track to another, hold the track button you wish to copy, then press M2 to copy it.

paste preset

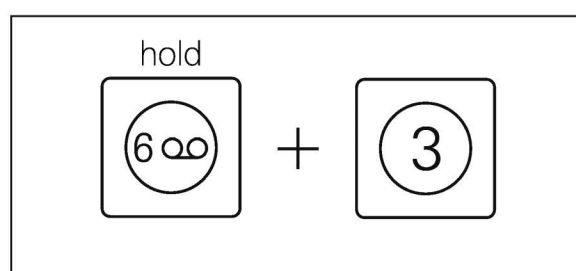

to paste a sound from one track to another, hold the track button for the track you wish to paste to and press M3 to paste it into that track.

save preset

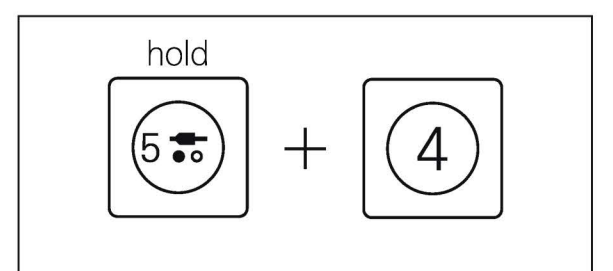

once you have a sound that you are happy with, you can save it as a preset by holding the track button for that track then pressing M4 to save it.

15. auxiliary

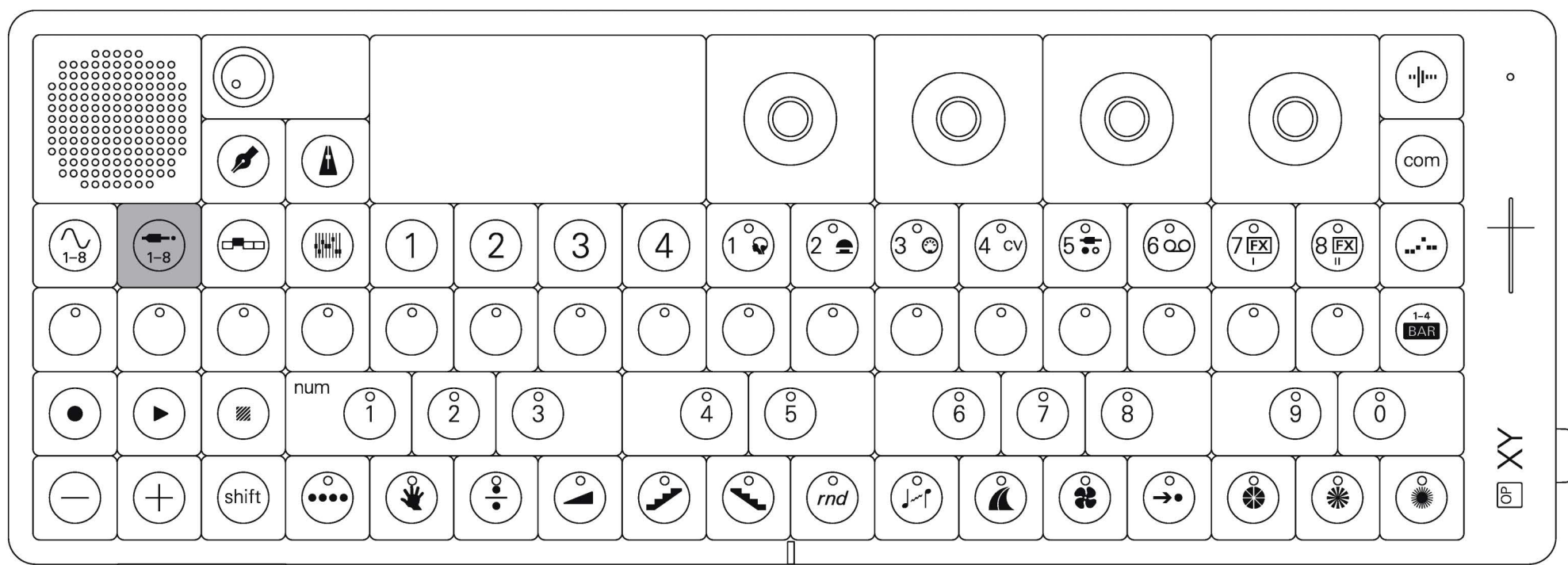

auxiliary mode holds 8 aux tracks ranging from midi effects to audio effects, as well as FX sends and punch in FX.

use the auxiliary tracks to vary OP-XY's built-in sounds, or even to control and send to external ones.

enter auxiliary mode

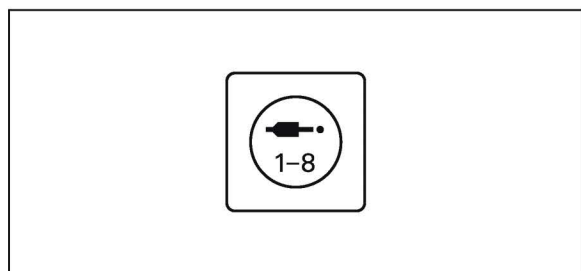

press auxiliary to open auxiliary mode.

15.1 brain

brain introduction

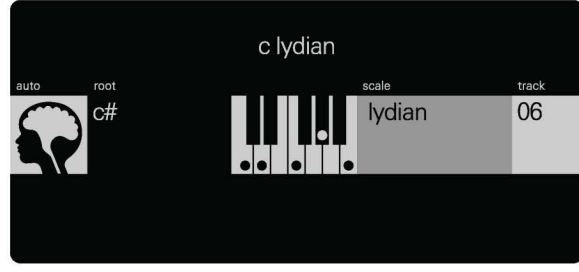

brain is an intelligent way of transposing your whole song or even just one track. brain will listen and figure out the key signature of your song, or even just the tracks you have selected.

brain track

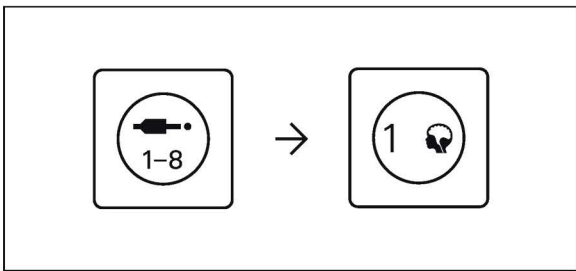

within the auxiliary tracks, track number 1 is the brain track.

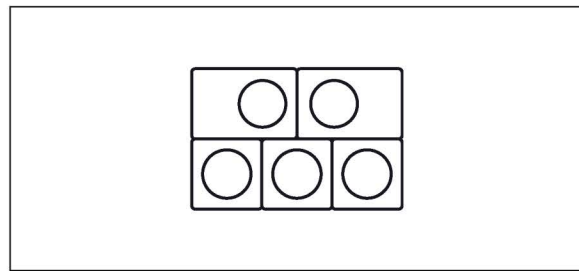

here, you can use the musical keyboard to transpose whatever tracks you have routed into the brain.

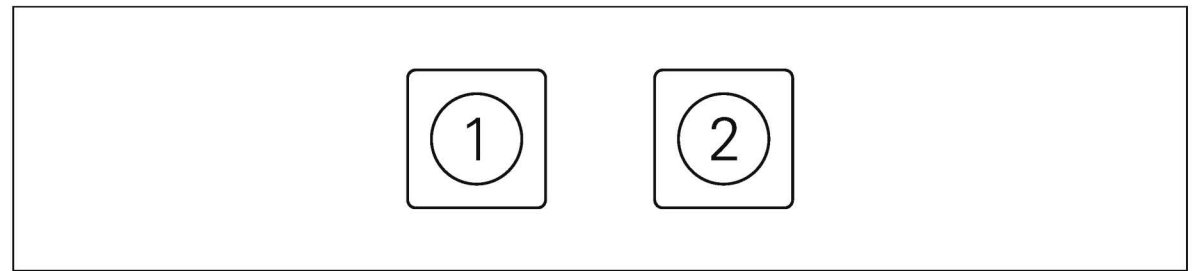

M1 holds the brain, where you can view and edit the scale of the song, and M2 is where you can route tracks through the brain.

manual/auto

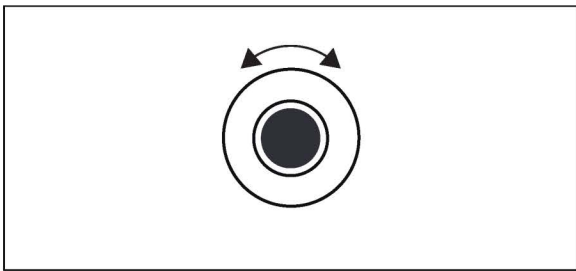

when in brain, rotate the dark gray knob to switch between manual key input or automatic key detection. manual allows you to select a different key to the one automatically detected by the device, making the transposition more accurate.

key

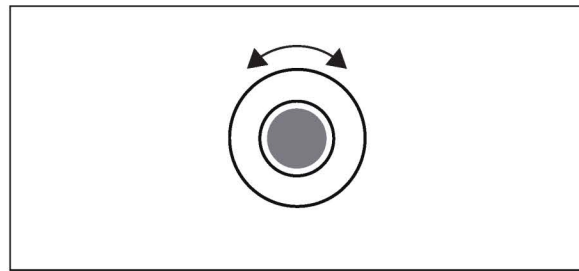

rotate the mid gray knob to select the key of your song.

scale

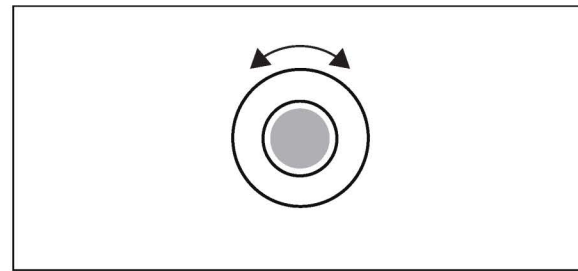

rotate the light gray knob to select the scale of your song.

link

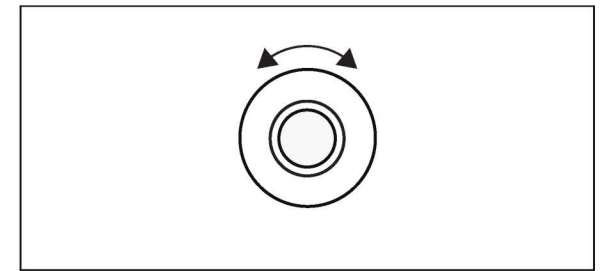

rotate the white knob to link any of the instrument tracks to the brain track, this allows you to riff over your song, while transposing it live.

routing

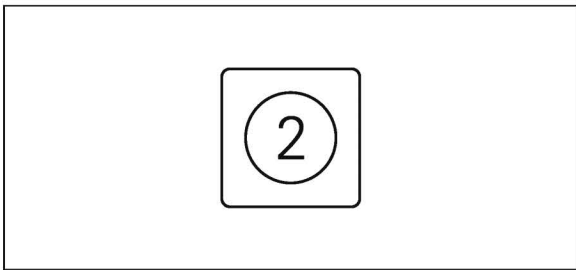

press M2 to view the routing module.

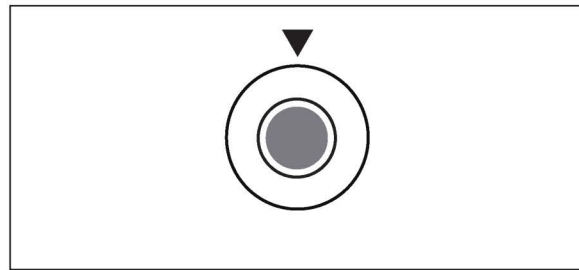

click any encoder to switch between instrument tracks 1-4 and 5-8.

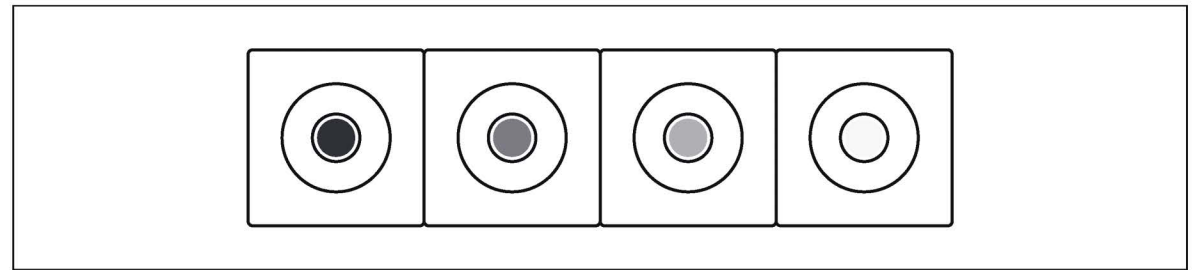

rotate the encoders to add or remove a track from the brain's routing, routed tracks will be transposed.

tracks that have not been routed will not be transposed. only routed tracks will affect the automatic key detection.

15.2 punch-in FX™

punch-in FX™ introduction

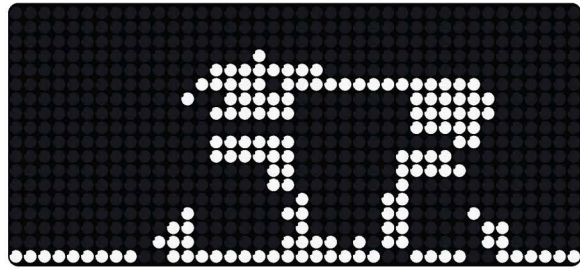
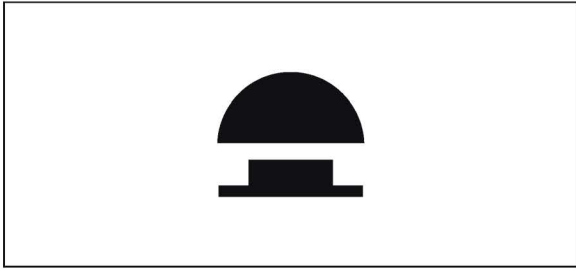

punch-in FX™ are a great way to quickly add variations to your song. use them while producing a track to get ideas then quickly record them in or perform them live to add powerful variations to your beat.

punch-in FX™ track

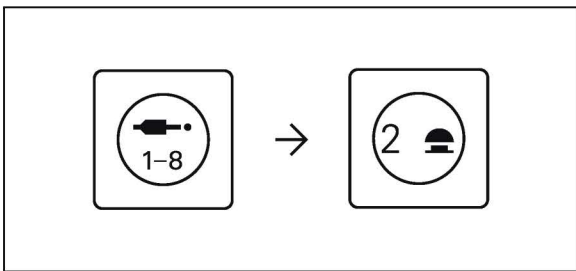

within the auxiliary tracks, track number 2 is the punch-in FX™ track.

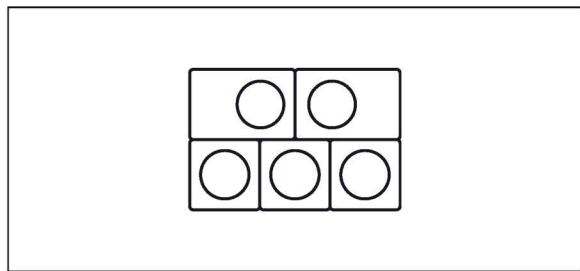

here, you can use the musical keyboard to play, record and perform with the punch-in FX™.

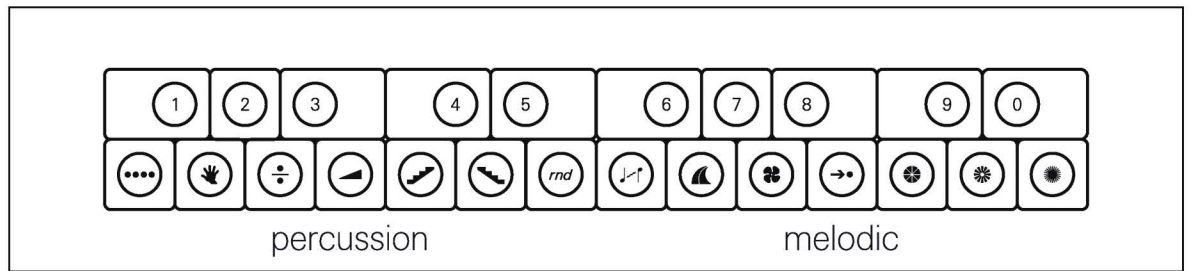

the lower octave adds punch-in FX™ to any percussion tracks, and the higher octave adds punch-in FX™ to melodic tracks.

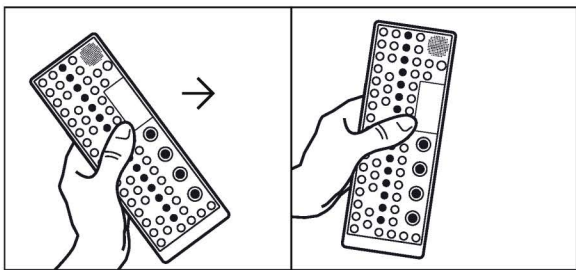

some punch-in FX™ will also make use of the accelerometer and pitchbend to add modulation or alter their behavior, try moving the device or pressing on the pitchbend while using the punch-in fx

per track punch-in FX™

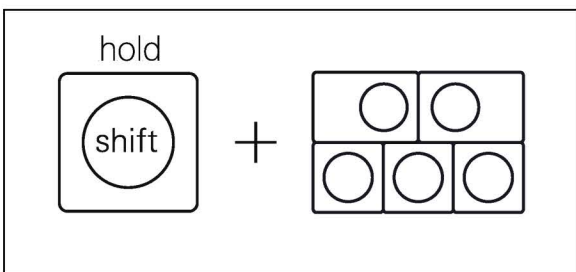

while in any instrument track, press and hold shift then press any of the keyboard keys to apply punch-in FX™.

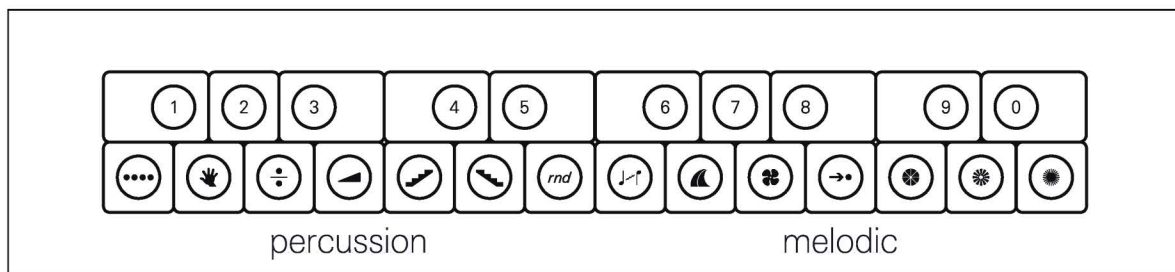

the low octave controls the individual track whereas the high octave modulates all tracks within that group (percussion or melodic).

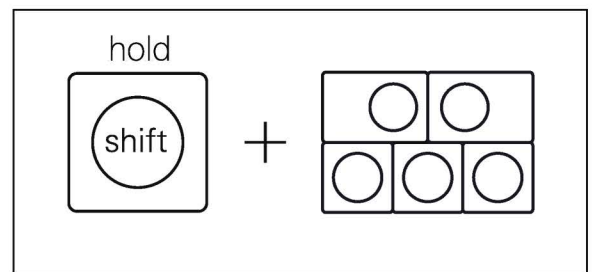

you can record track specific punch-in FX™ by starting a recording then holding shift and playing them on the keyboard. punch-in FX™ will record to the punch-in FX™ track in auxiliary.

15.3 external midi

external midi introduction

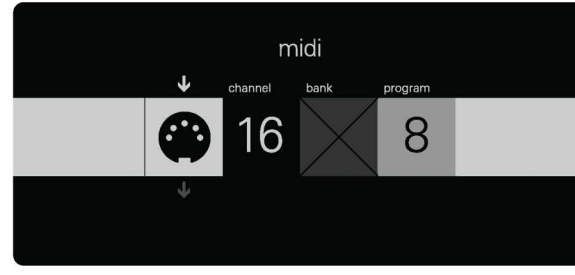
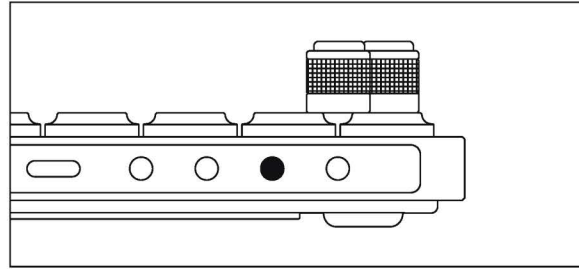
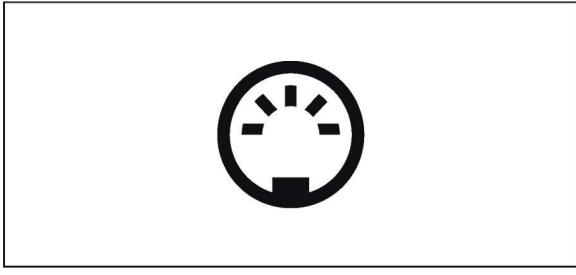

connecting other gear to OP-XY is a fantastic way to open up new musical possibilities, or even just add a couple of extra sounds. the external midi track allows you to control those external devices.

to connect and control external midi devices, you can use the usb-c port or the multi-out jack.

learn more about setting up the multi-out in the [multi-out chapter](#).

external midi track

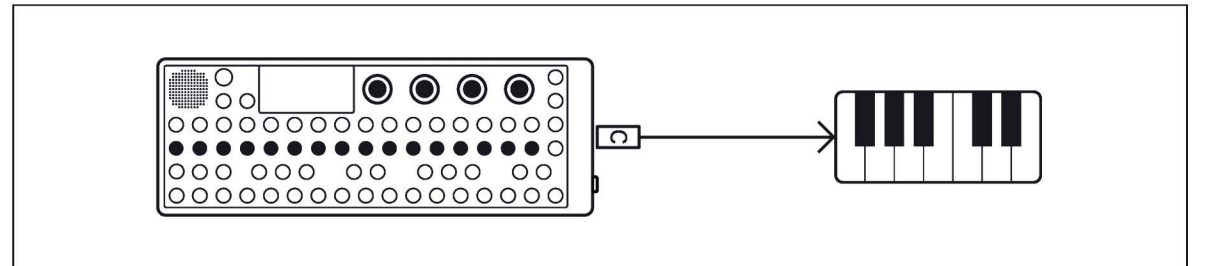
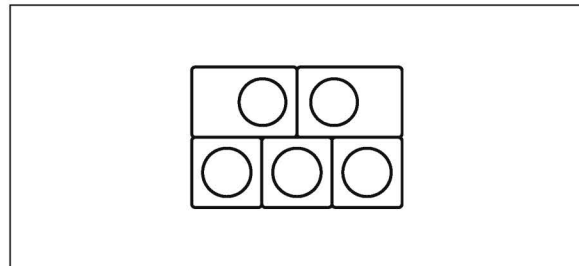
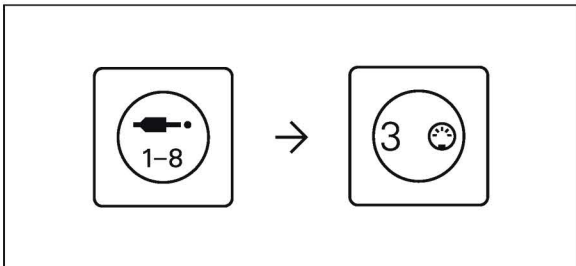

within the auxiliary tracks, track number 3 is the external midi track.

here you can use the musical keyboard to play notes on external midi devices, as well as sequence those notes on the sequencer.

in the external midi track you can control which midi channel, bank and program you want to control as well as offering 8 midi ccs that can be edited, sequenced and recorded.

channel, bank and program

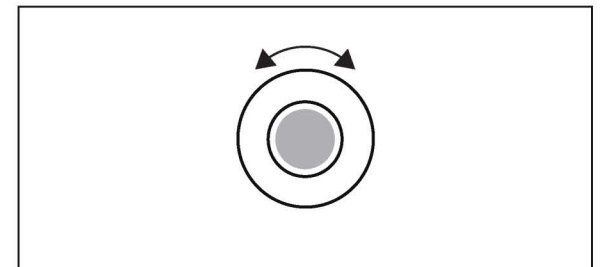
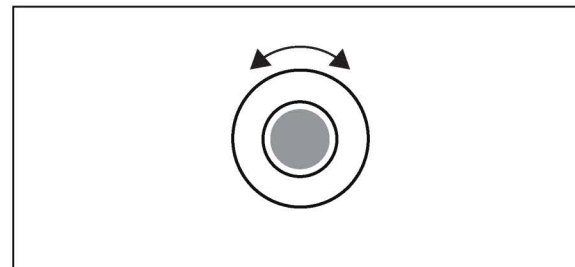
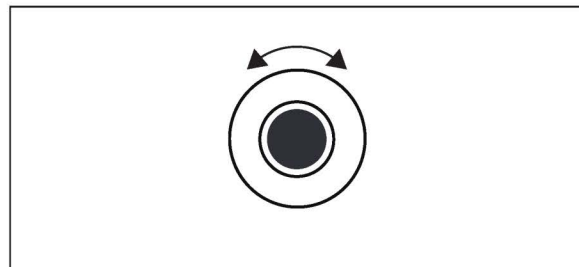
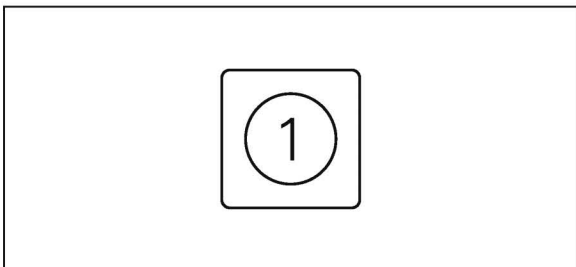

within M1 you will find the controls for channel, bank and program. in a typical midi set up, each device listens to a different channel. some devices may use banks and programs to select a particular sound.

rotate the dark gray knob to select midi channel.

rotate the mid gray knob to select the bank.

rotate the light gray knob to select a program.

midi CCs

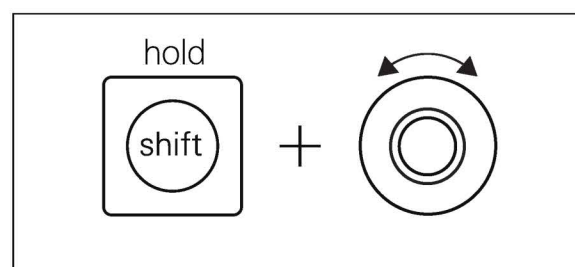
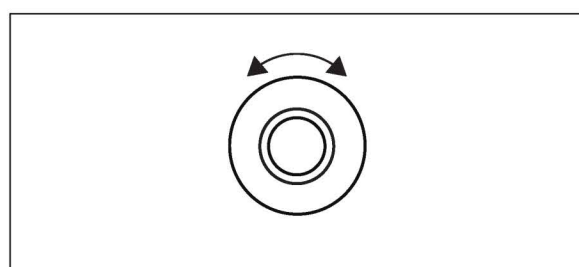
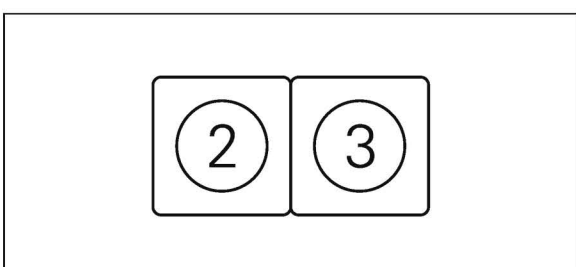

within M2 and M3 you will find the midi ccs.

rotate each of the encoders to edit the available ccs.

hold shift and rotate the encoders to turn on or select the cc message.

lfo

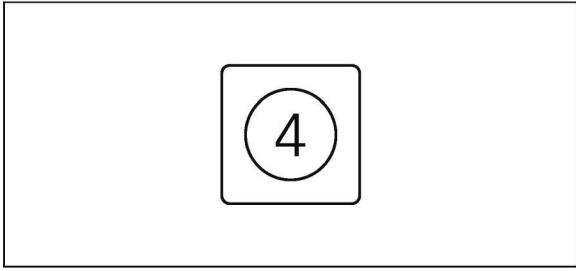

M4 is where you can find the lfo. use it to modulate parameters within the external midi track.

speed

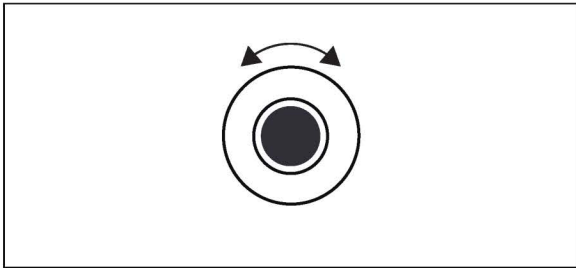

rotating the dark gray knob will adjust the speed of the lfo.

amount

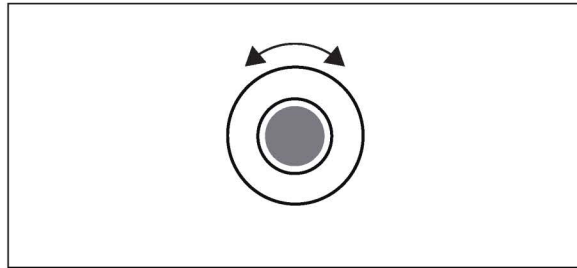

rotating the mid gray knob will adjust the amount that the lfo affects the destination parameter.

destination

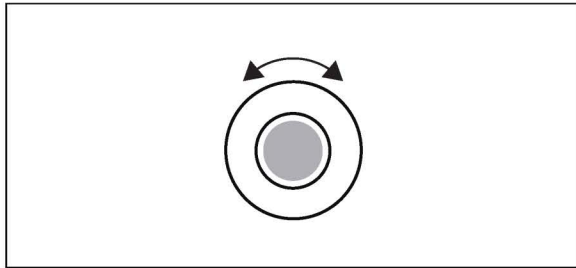

rotating the light gray knob will select the destination on the track, this is the module that you wish to assign the lfo to.

parameter

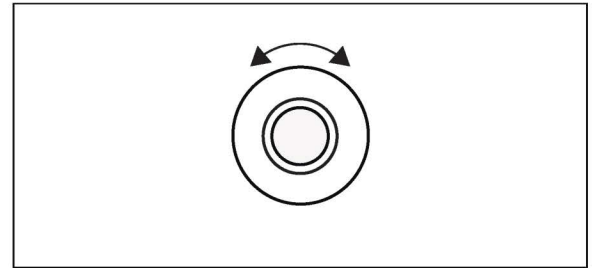

rotating the white knob will select the parameter you wish to modulate, this is the encoder on the destination module that you wish to modulate.

15.4 external cv

external cv introduction

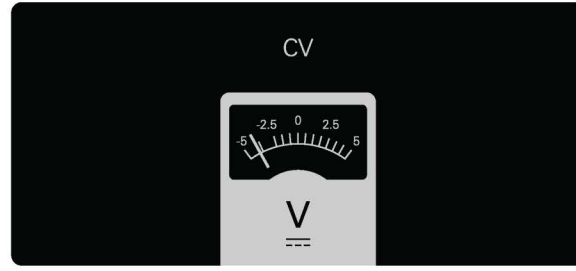
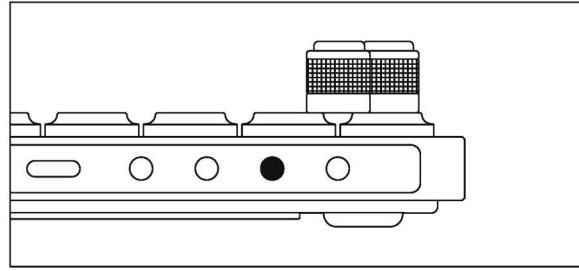
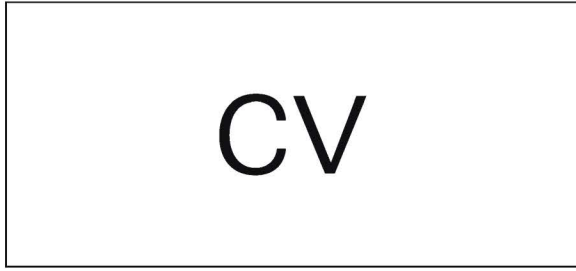

modular and vintage synths use a control voltage signal to determine the pitch of a note.

to connect and control cv devices, you can use the multi-out jack. cv is output on the tip (left channel) and gate on the ring (right channel).

learn more about setting up the multi-out in the [multi-out chapter](#).

external cv track

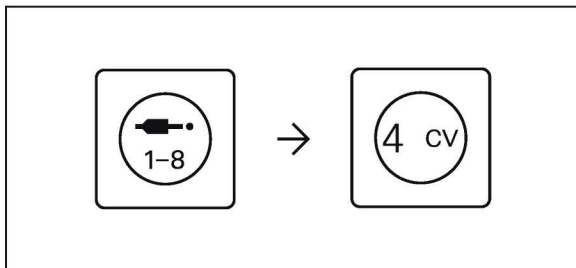

within the auxiliary tracks, track number 4 is the external cv track.

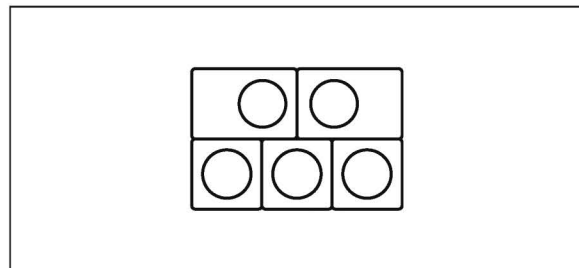

here you can use the musical keyboard to play notes on the connected cv device, as well as sequence those notes on the sequencer.

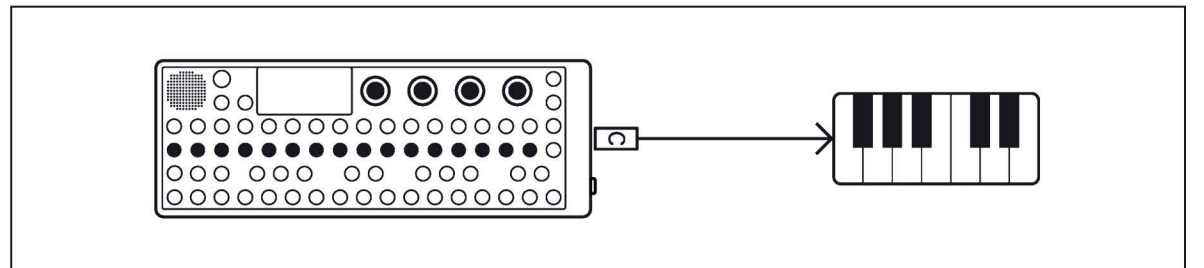

in the external cv track, control voltage is sent through the connected cable.

15.5 external audio

introduction

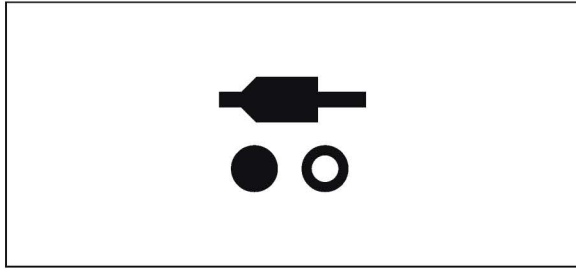

sending and receiving audio is a core part of any music workflow. use the external audio track to manage audio in and out of OP–XY

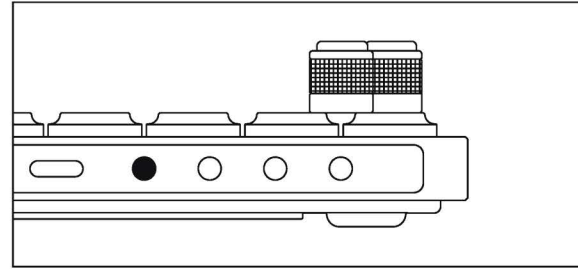

inputting audio on OP–XY is as simple as plugging a 3.5mm jack into the audio input.

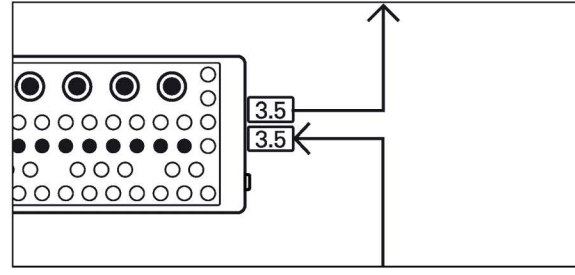

to send auxiliary audio out of OP–XY, you will need to set the multi-out to output audio and plug in a 3.5mm cable.

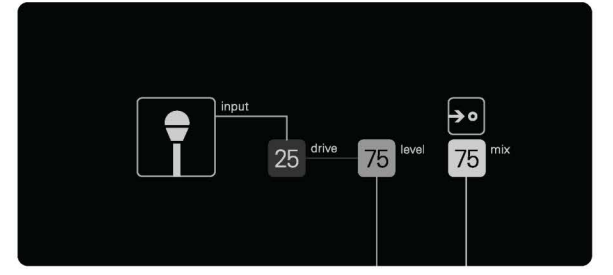

learn more about setting up the multi-out in the [multi-out chapter](#).

external audio track

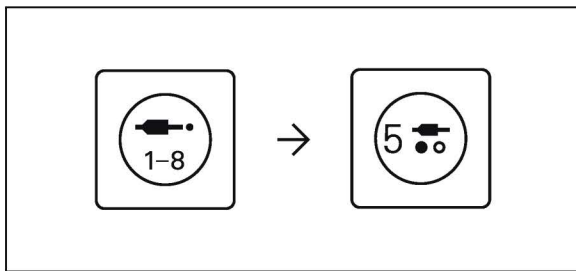

within the auxiliary tracks, track number 5 is the external audio track.

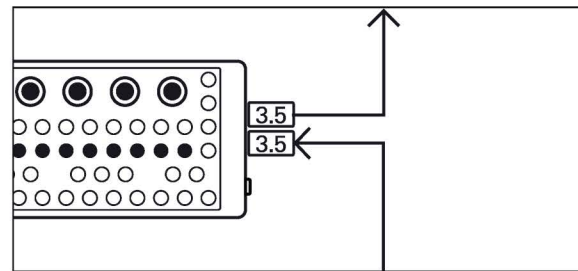

here you can route audio into and out of OP–XY.

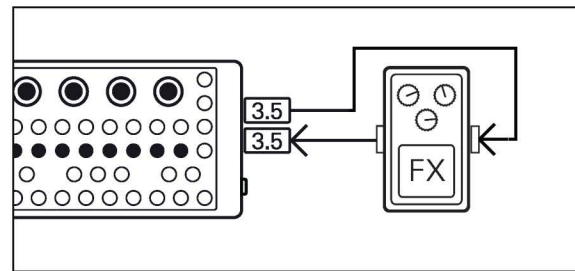

use the aux out from the multi-out jack to send to fx pedals and then the audio in to route it back into OP–XY.

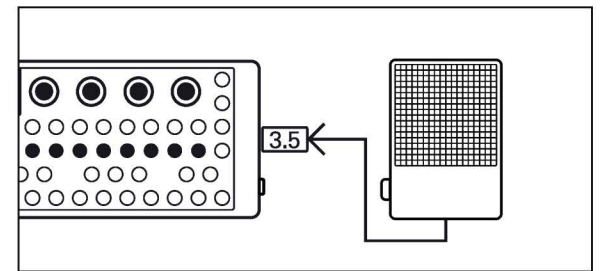

use the line input to connect a microphone and send vocals, trumpets or any other sounds into your OP–XY.

input

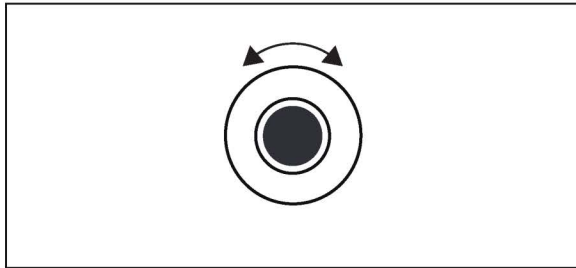

rotate the dark gray knob to select the input into the external audio track. you can select from: mic, headset, audio input, usb audio and main output.

drive

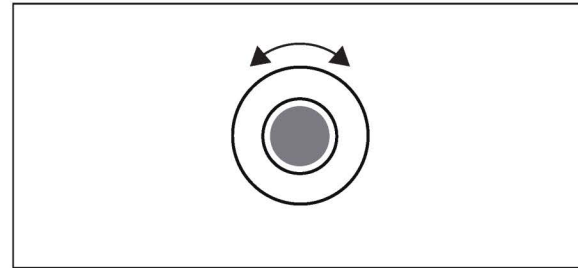

rotate the mid gray encoder to adjust the drive (gain) of the audio input. this only applies to analog inputs and uses the built in preamps in OP–XY.

level

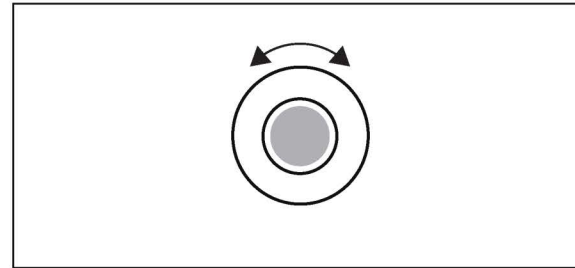

rotate the light gray encoder to adjust the level of the audio input, this is the volume in the master mix from whatever input you have selected.

mix

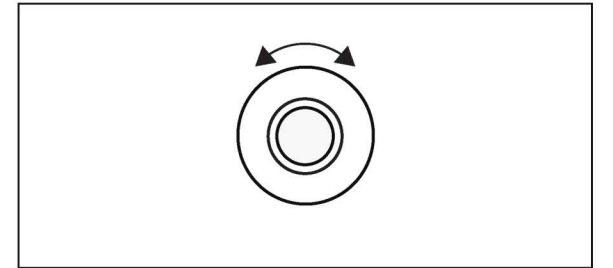

rotate the white encoder to adjust the mix into the main output. this will take whatever tracks you route through the external audio track and feed them into the main mix.

activate input

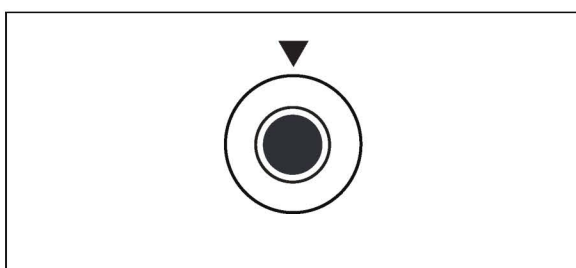

click down the dark gray knob to activate the selected audio input.

routing

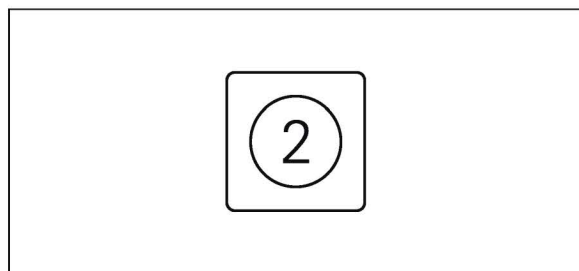

press M2 to view the routing module. this is where you can send instrument tracks through the external audio output on the multi-out jack.

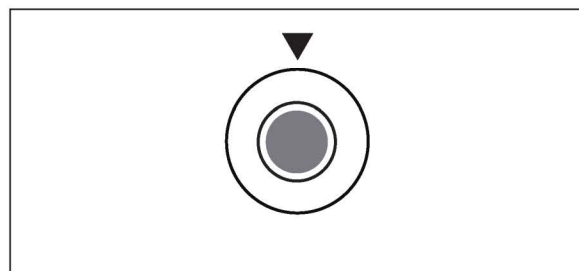

click any encoder to switch between instrument tracks 1-4 and 5-8.

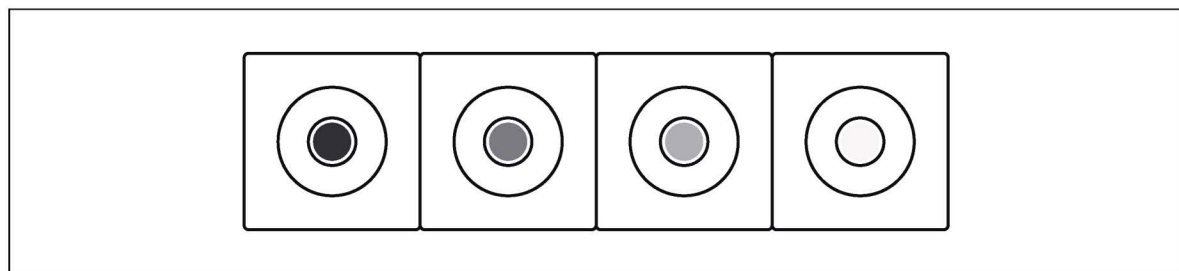

rotate the encoders to add or remove a track from the aux audio routing, only routed tracks will run out of the aux output.

you can set the amount of audio coming into the external audio track from each track which can be totally different to the main mix.

filter

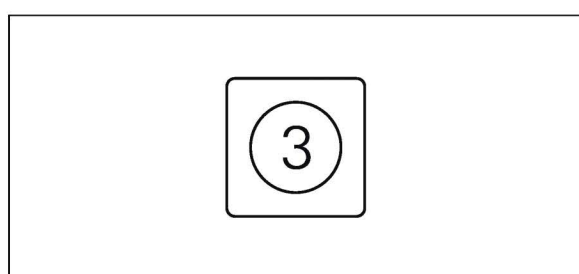

press M3 to edit the filter.

the external audio track features a high-pass/low-pass filter.

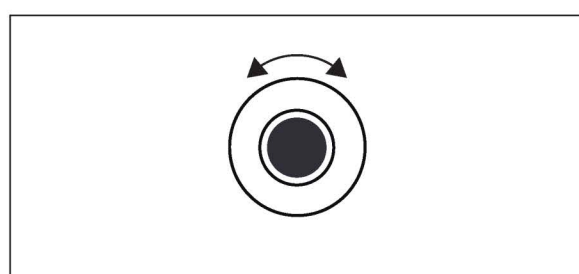

rotate the dark gray knob to edit the high-pass cut-off frequency.

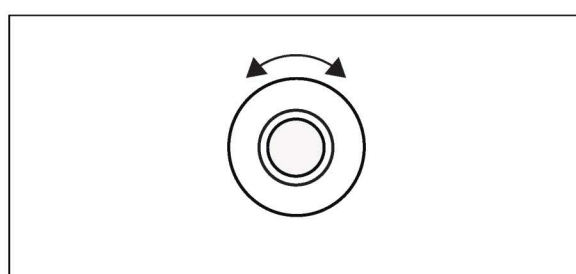

rotate the white knob to adjust the low-pass cutoff frequency.

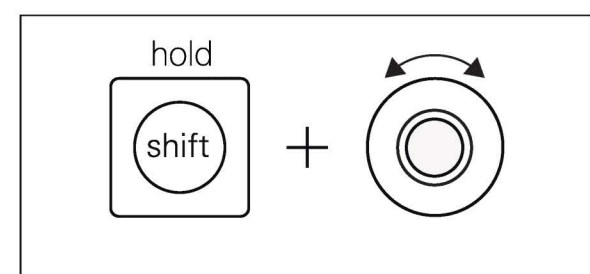

hold shift and rotate the mid gray knob to adjust tape send level or rotate the light gray and white encoders to control the fx send levels.

lfo

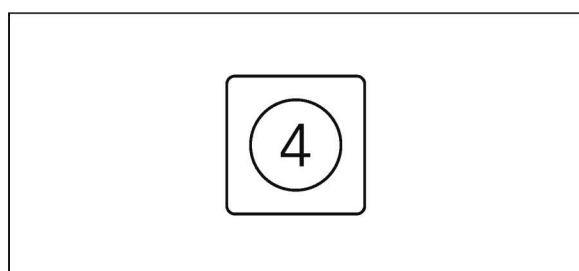

M4 is where you can find the lfo. use it to modulate parameters within the external audio track.

speed

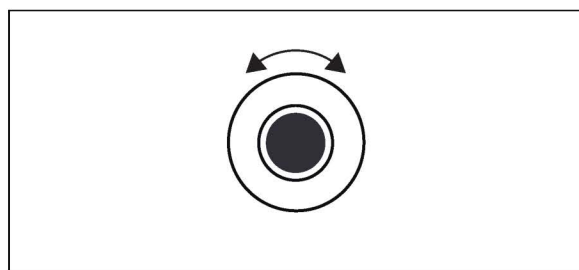

rotating the dark gray knob will adjust the speed of the lfo.

amount

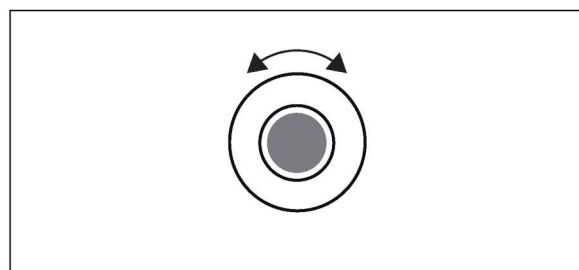

rotating the mid gray knob will adjust the amount that the lfo affects the destination parameter.

destination

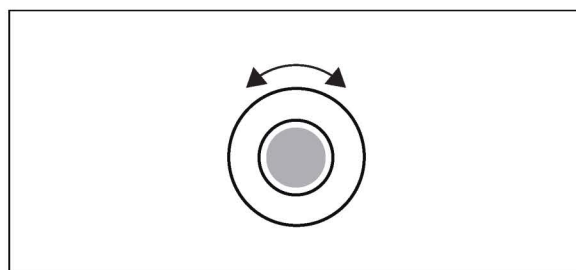

rotating the light gray knob will select the destination on the track, this is the module that you wish to assign the lfo to.

parameter

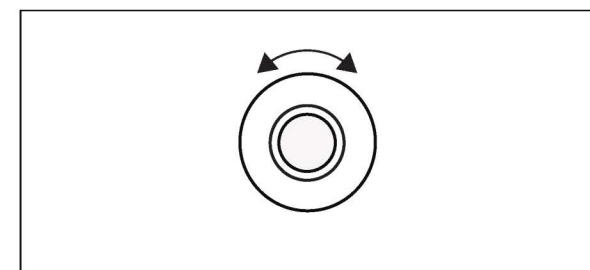

rotating the white knob will select the parameter you wish to modulate, this is the encoder on the destination module that you wish to modulate.

15.6 tape

tape introduction

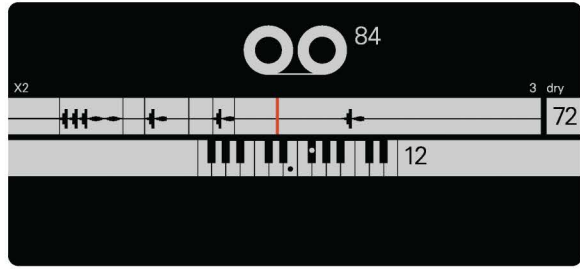
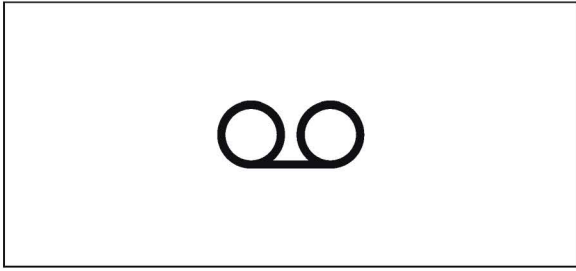

tape is where you can pick out and rearrange audio playing within the device and can produce some awesome glitchy effects.

tape track

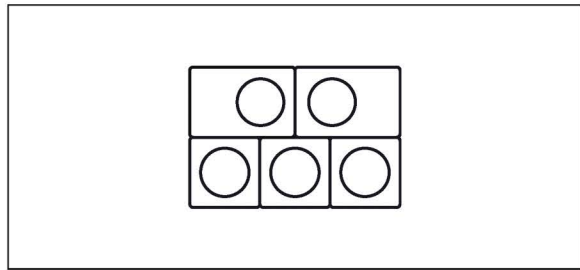
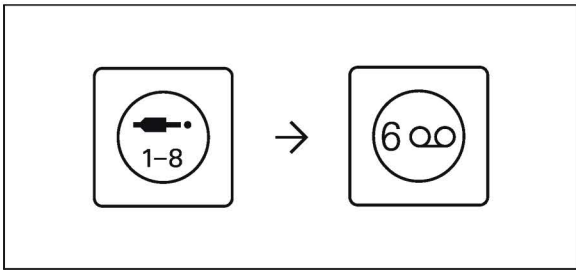

within the auxiliary tracks, track number 6 is the tape track.

here, you can use the musical keyboard to play clips from any tracks routed into the tape.

pitch

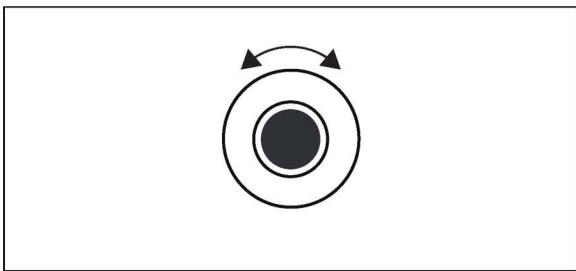

when in tape, rotate the dark gray knob to adjust the pitch of the tape, this can create some crazy sounds and creative effects.

speed

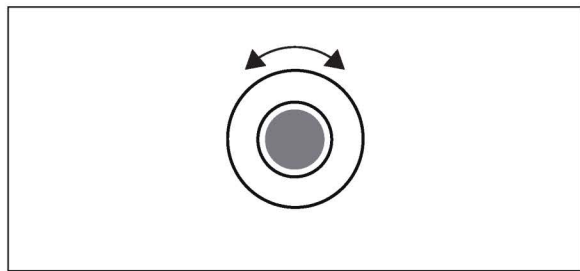

rotate the mid gray knob to adjust the speed of the tape, this is a more gentle and precise way of adjusting how fast it plays back.

length

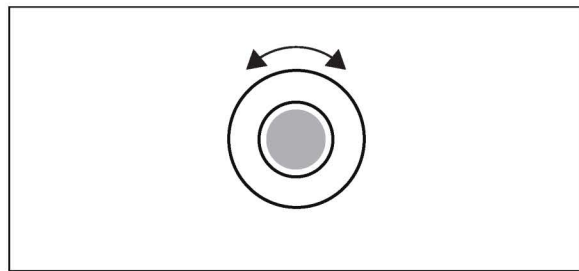

rotate the light gray knob to change the length of the loop made on the tape.

mix

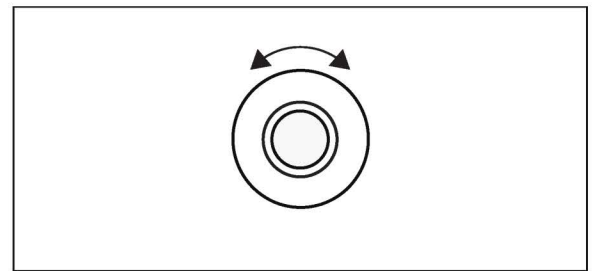

rotate the white knob to adjust the mix of tape and original audio.

routing

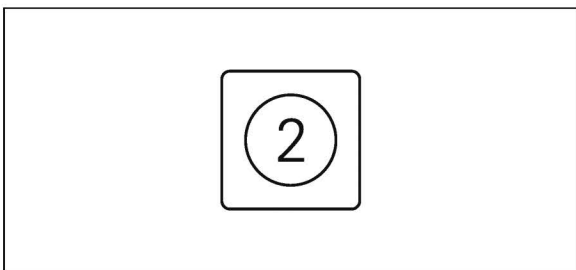

press M2 to view the routing module.

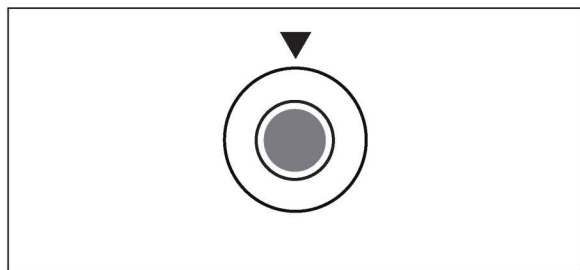

click any encoder to switch between instrument tracks 1-4 and 5-8.

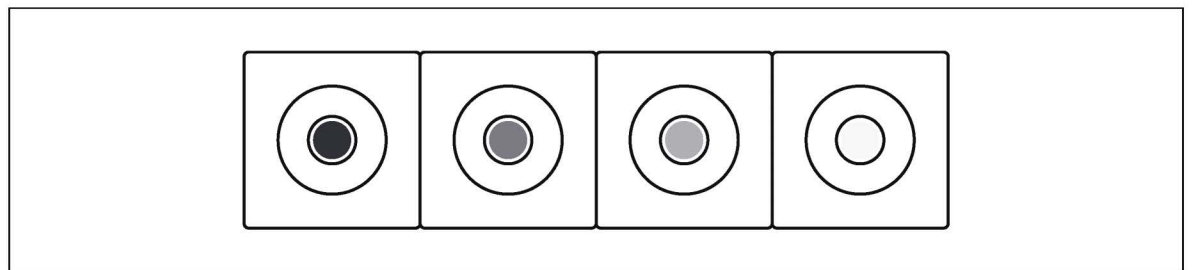

rotate the encoders to add or remove a track from the tape's routing, only routed tracks will run through the tape.

you can set the amount of audio coming into the tape from each track which can be totally different to the main mix.

filter

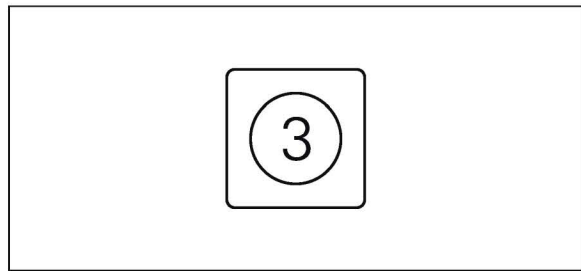

press M3 to edit the filter.

the tape track features a high-pass/low-pass filter.

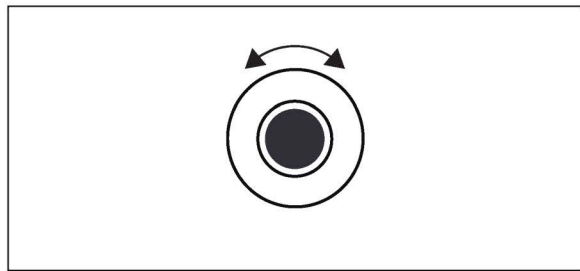

rotate the dark gray knob to edit the high-pass cutoff frequency.

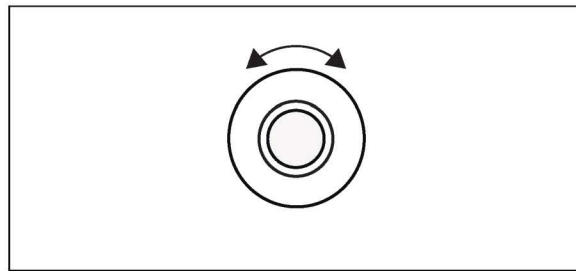

rotate the white knob to adjust the low-pass cutoff frequency.

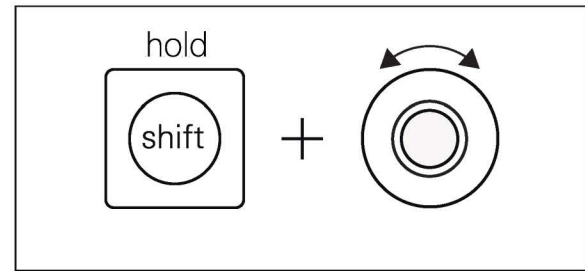

hold shift and rotate the light gray and white knobs to control the fx send levels.

lfo

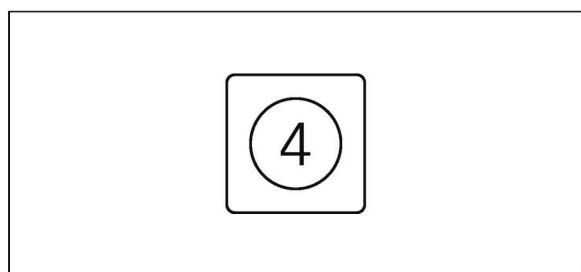

M4 is where you can find the lfo. use it to modulate parameters within the tape to get even crazier.

speed

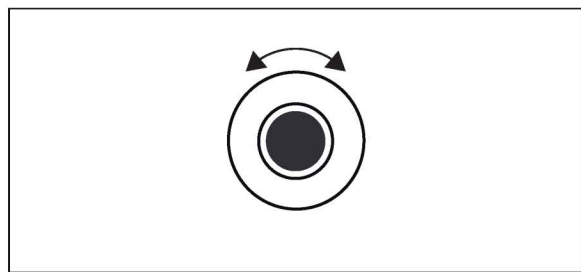

rotating the dark gray knob will adjust the speed of the lfo.

amount

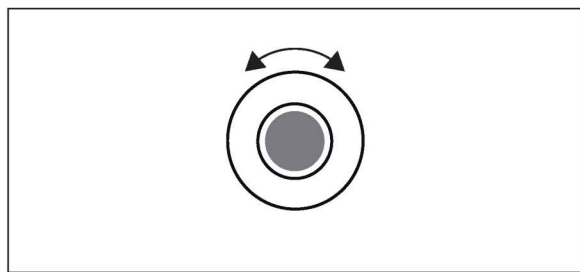

rotating the mid gray knob will adjust the amount that the lfo affects the destination parameter.

destination

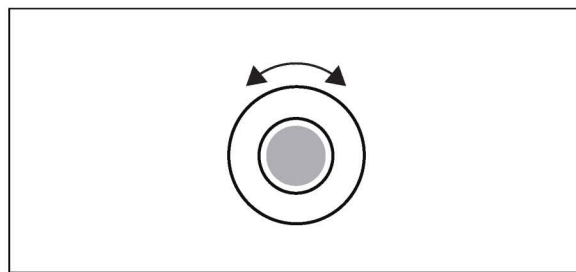

rotating the light gray knob will select the destination on the track, this is the module that you wish to assign the lfo to.

parameter

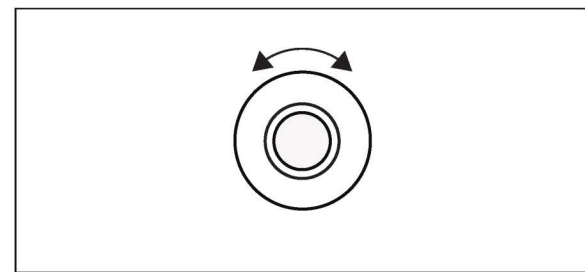

rotating the white knob will select the parameter you wish to modulate, this is the encoder on the destination module that you wish to modulate.

15.7 FX I and FX II

FX introduction

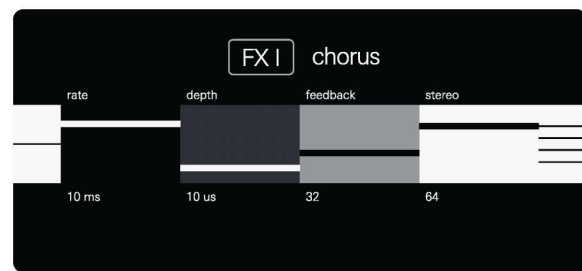

FX I and II hold the two fx sends within OP-XY. you can send any track that FX I and II and you can even send FX I to FX II.

FX tracks

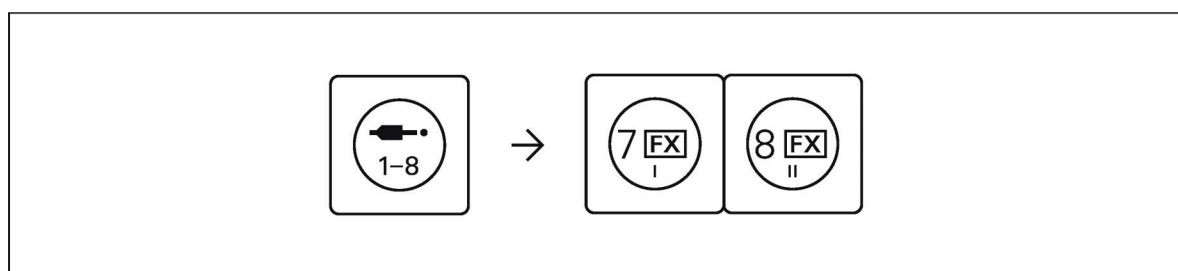

within the auxiliary tracks, tracks number 7 and 8 are the FX tracks.

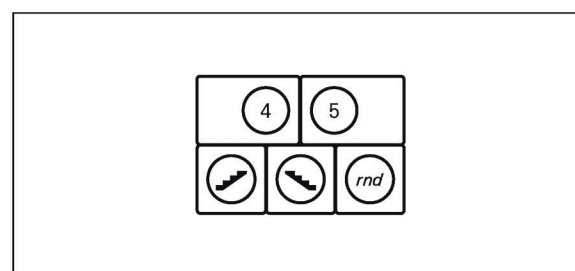

here, the musical keyboard will allow you to play whatever the last selected instrument track was. this allows you to preview the effect on whatever sound you are currently editing.

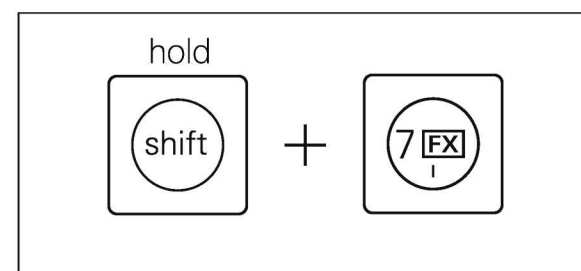

hold shift and press FX I or FX II to change the FX on the chosen slot. you can then use the encoders to select the FX.

FX engine

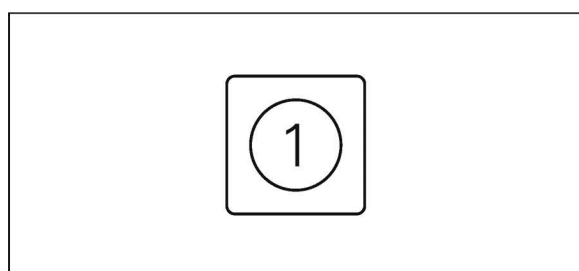

press M1 to view and edit the parameters for the currently selected FX engine.



you can learn more about the available FX and their parameters in the [FX chapter](#).

routing

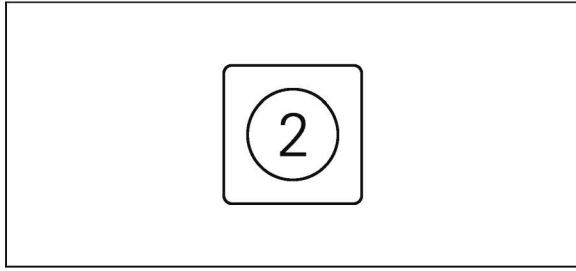

press M2 to view the routing module.

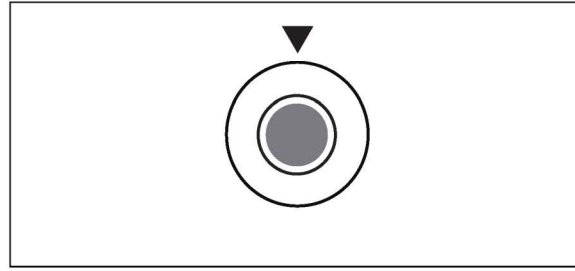

click any encoder to switch between instrument tracks 1-4 and 5-8.

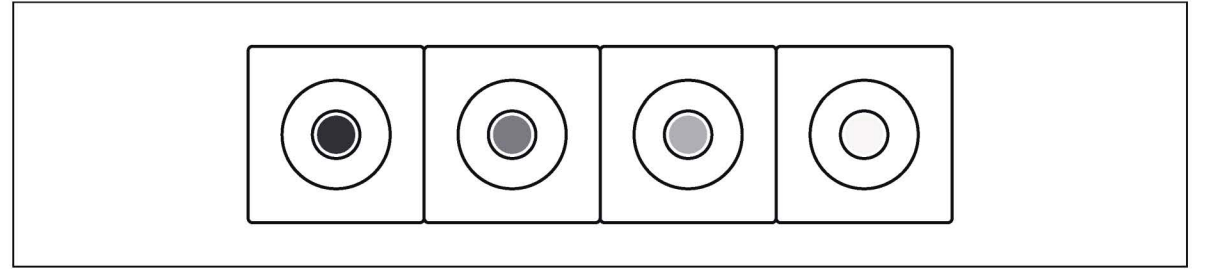

rotate the encoders to add or remove a track from the FX's routing, only routed tracks will run through the FX.

filter

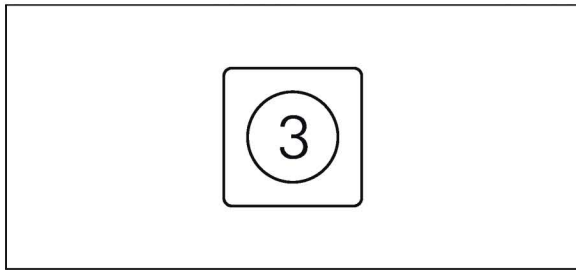

press M3 to edit the filter.

the tape track features a high-pass/low-pass filter.

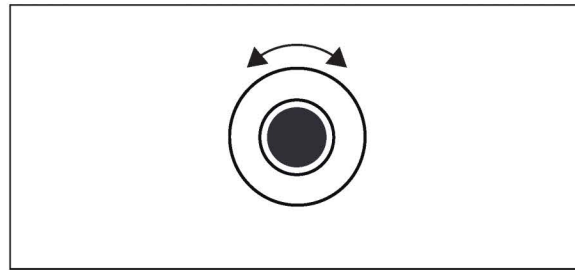

rotate the dark gray knob to edit the high-pass cutoff frequency.

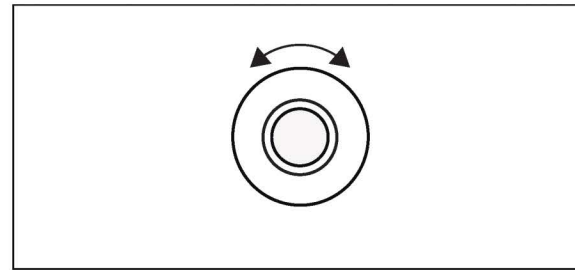

rotate the white knob to adjust the low-pass cutoff frequency.

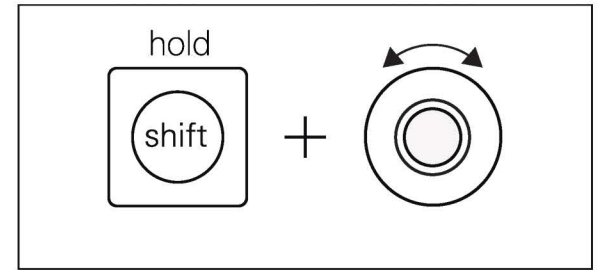

when in FX I, hold shift and rotate the white knob to control the send level to FX II from FX I.

lfo

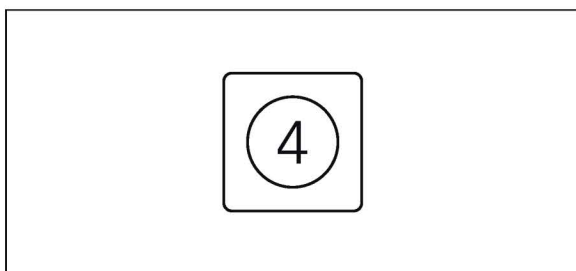

M4 is where you can find the lfo. use it to modulate parameters within the FX to add interesting modulations.

speed

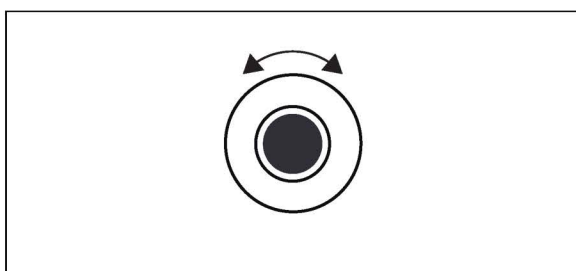

rotating the dark gray knob will adjust the speed of the lfo.

amount

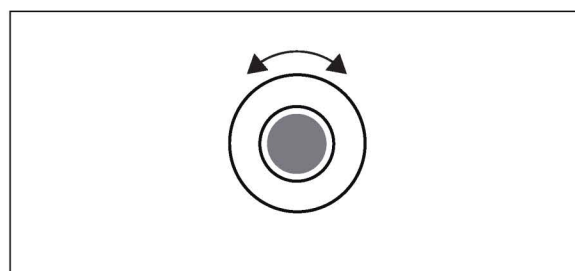

rotating the mid gray encoder will adjust the amount that the lfo affects the destination parameter.

destination

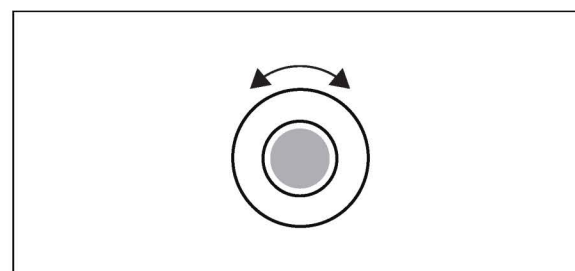

rotating the light gray encoder will select the destination on the track, this is the module that you wish to assign the lfo to.

parameter

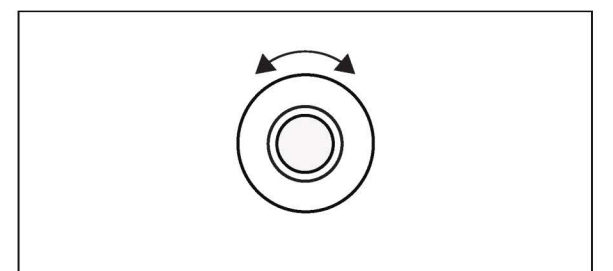

rotating the white knob will select the parameter you wish to modulate, this is the encoder on the destination module that you wish to modulate.

16. arrange

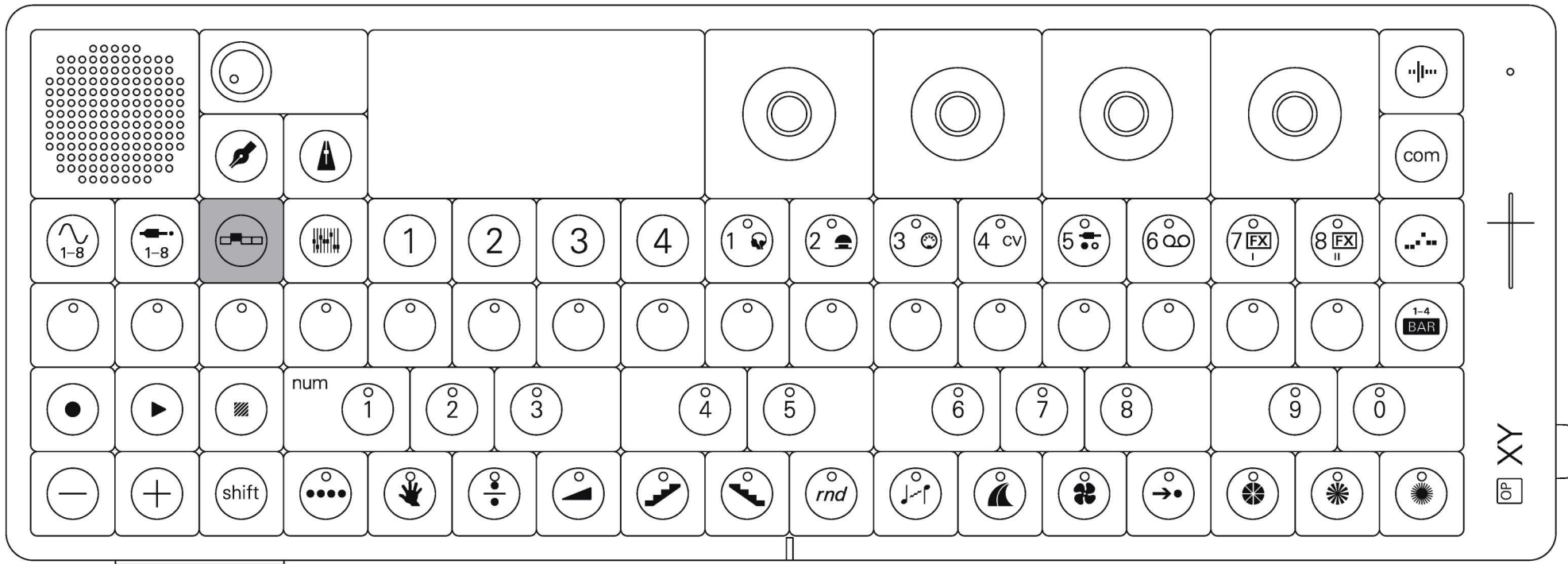

arrange mode is where you can create new patterns, move between them and arrange them into songs.

arrange is an incredibly powerful and fun part of OP-XY and can be used both when creating a song, and performing it.

enter arrange mode

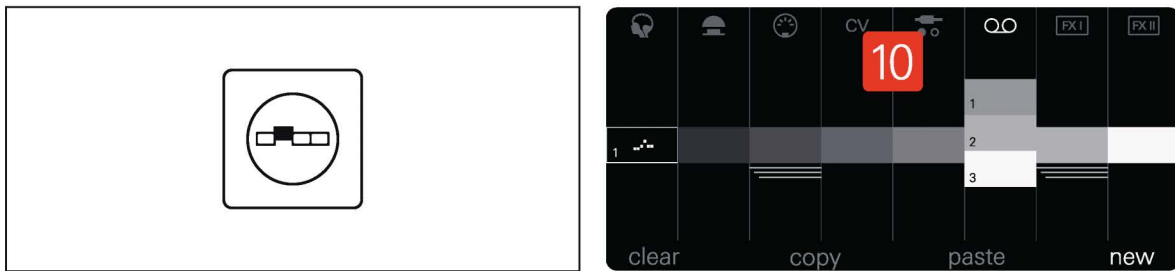

press arrange to open arrange mode.

16.1 switching tracks and patterns

switching tracks

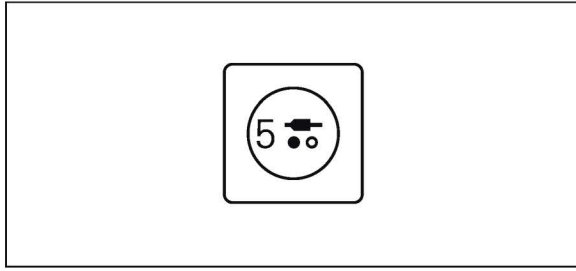

press the track button corresponding to the track you wish to edit and arrange.

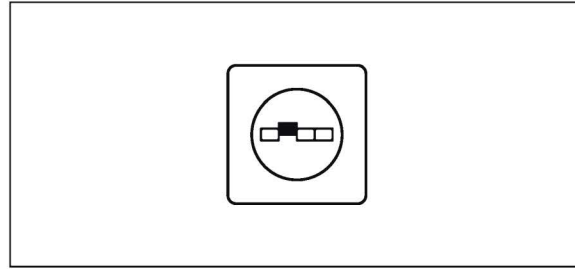

press arrange while in arrange mode to switch between instrument and auxiliary tracks. you can create and edit patterns for both instrument and auxiliary tracks.

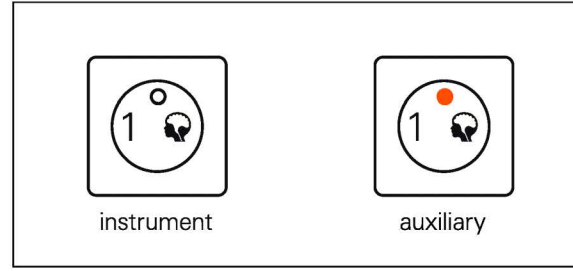

just as in any other mode, instrument tracks will light up in white and auxiliary in red, allowing you to quickly identify what tracks you are editing and arranging.

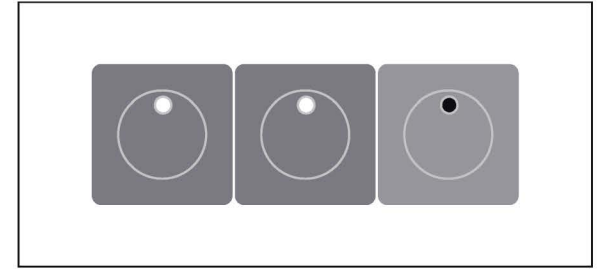

you'll notice that when you are in a chosen track the sequencer will light up with the sequence recorded to that track and pattern.

navigating patterns

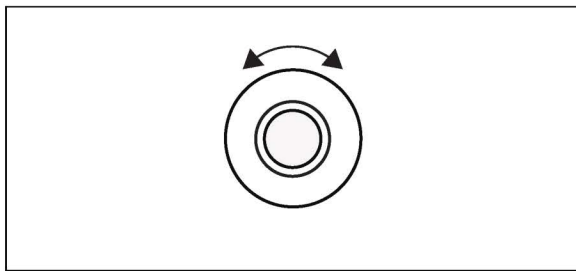

rotate the white knob to move between existing patterns in the selected track.

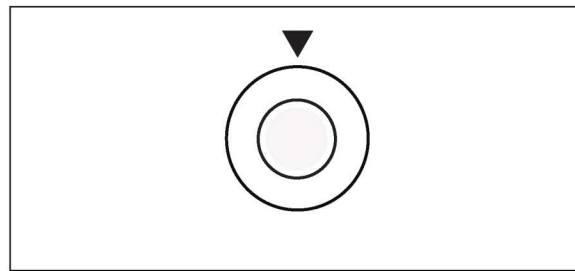

click the white knob to mute the selected track.

16.2 edit controls

new

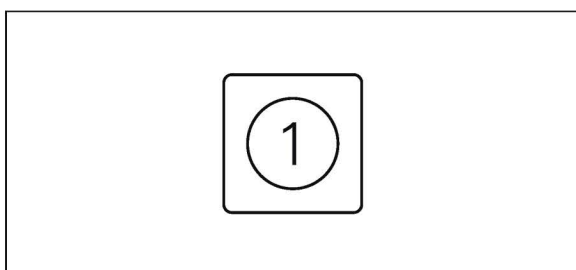

press M1 while in arrange to create a new pattern on the currently selected track (lit in white or red). a track can hold a maximum of 9 patterns.

copy

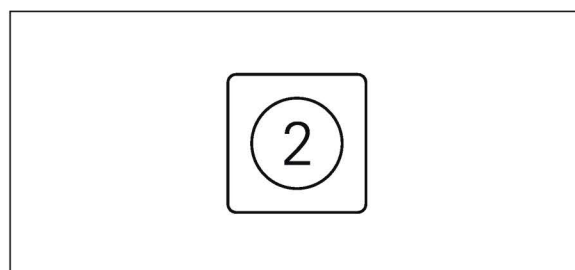

press M2 to copy the currently selected pattern, engine and all other parameters. this can then be pasted within the same track to quickly add variations on an existing pattern, or to another track to create more complex arrangements with multiple instrument changes per track.

paste

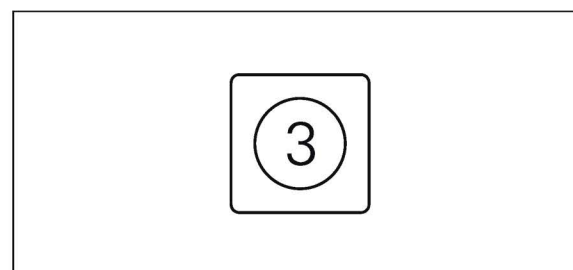

press M3 to paste a copied pattern, when pasting from one track to another the entire instrument will paste on that new pattern, including the engine and all parameters.

clear

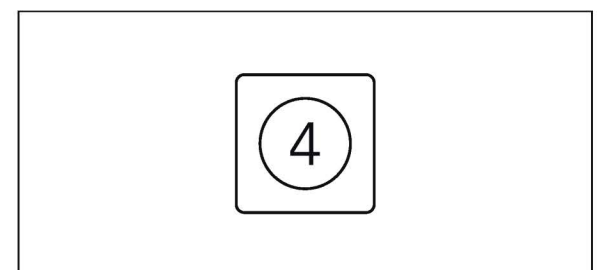

press M4 to remove a pattern from a track.

16.3 scenes and song mode

scenes

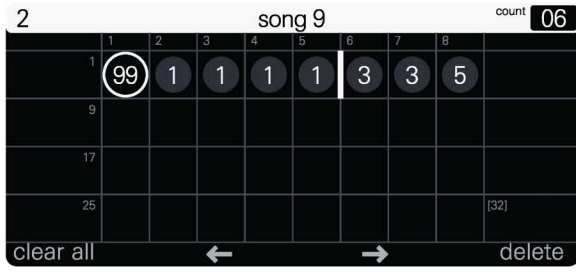

arrange mode allows you to group patterns into 99 distinct scenes. each scene remembers the pattern arrangement as well as the mix settings. scenes are as long as their longest pattern.

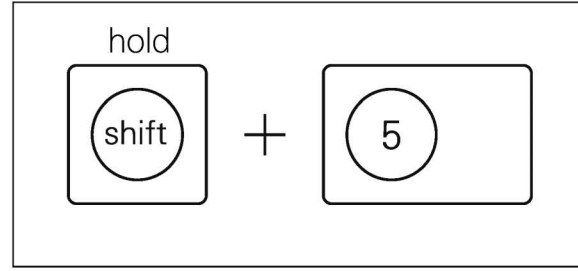

hold shift and press the accidental keys to select a scene. each accidental is numbered and thus corresponds to a different scene number.

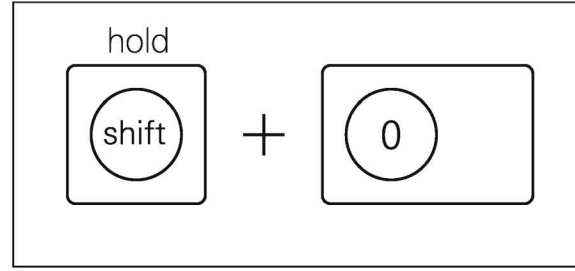

the final accidental (d#) is your gateway to scenes 10-99. press it, then enter the number you wish to navigate to using the other accidental keys.

song mode

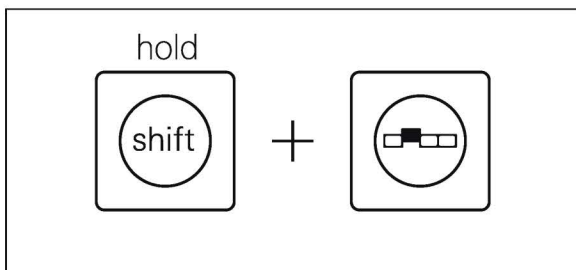

while holding shift in arrange, press arrange to enter song mode and edit the song.

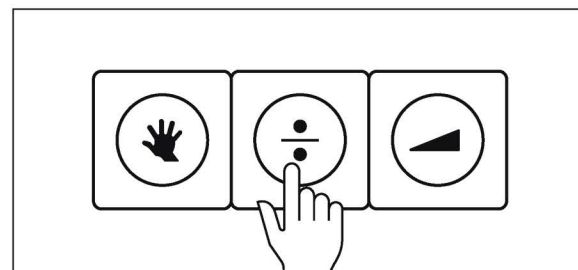

when prompted, press any natural key to create a song.

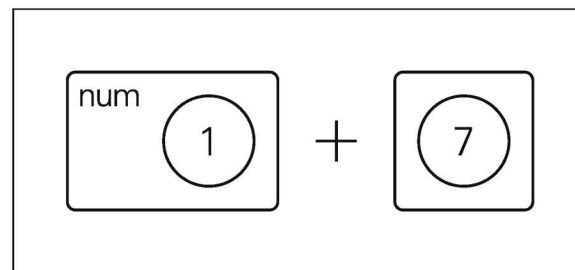

press the accidentals to select the scenes you'd like to sequence in your song. think of it like entering a phone number.

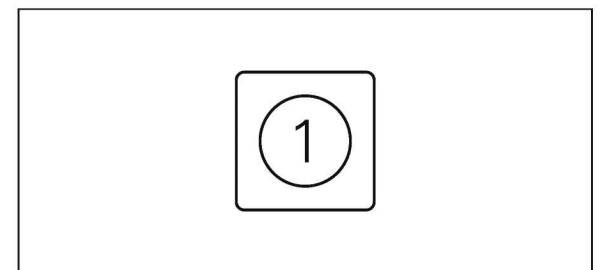

press M1 to clear all scenes from your song order to start fresh with the arrangement. this won't delete the scenes outright, just remove them from the song's playback.

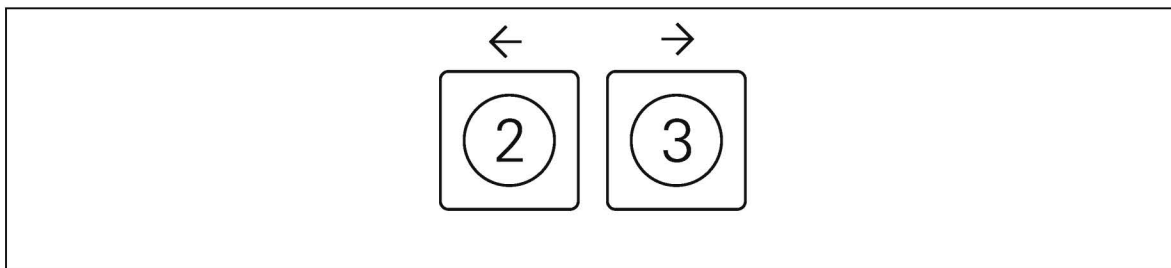

you can use M2 and M3 to navigate between the recorded scenes in your song, this allows you to insert scenes between others as well as delete scenes from your song.

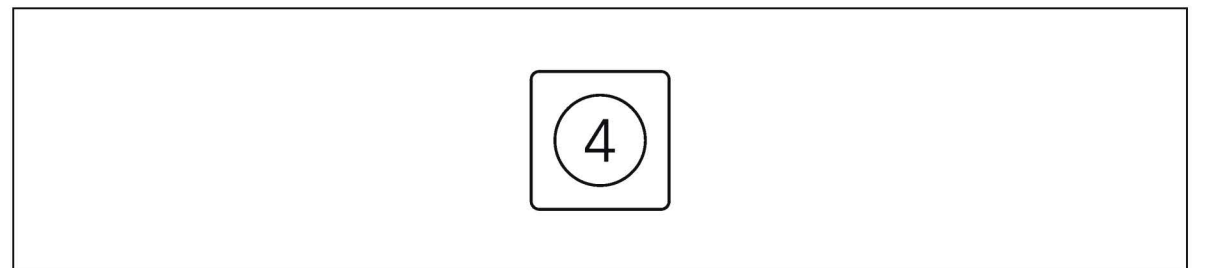

press M4 to delete a scene from the song. this won't delete the scene outright, just remove it from the song's playback.

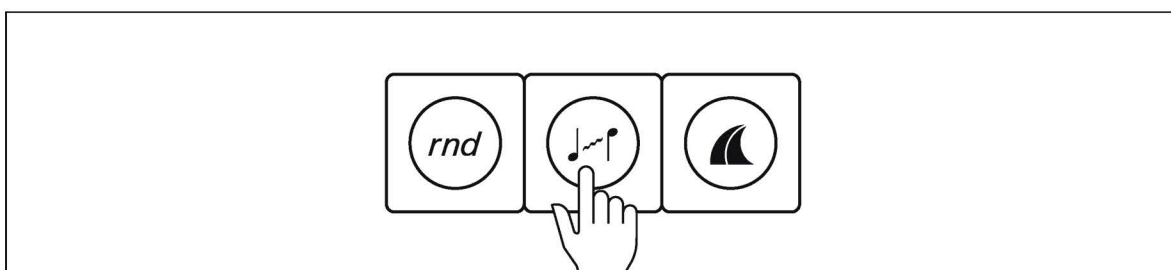

press the naturals to select a different song. you can arrange up to 10 songs per project.

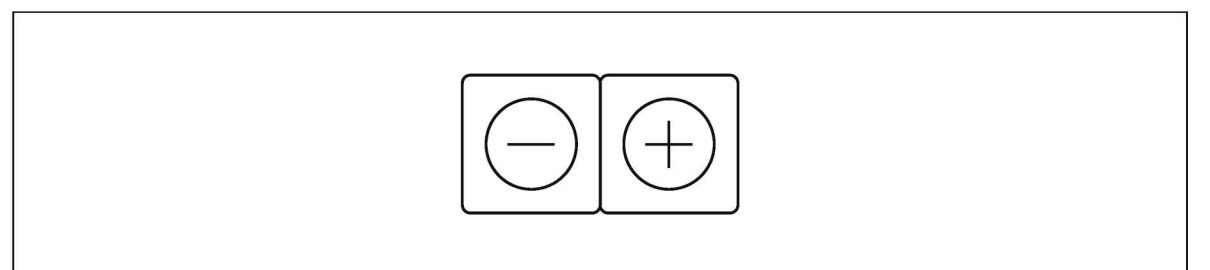

use (-) and (+) to cue up a future scene and jump forwards in your song.

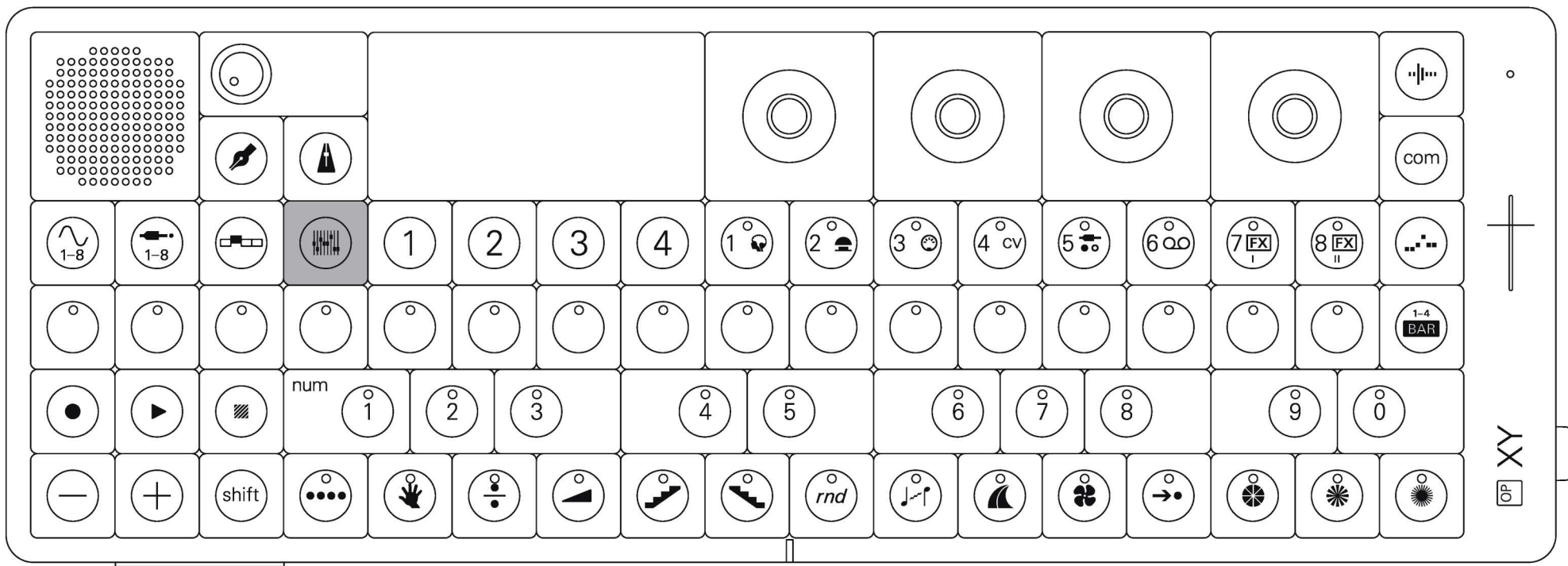

mix allows you to create the perfect balance in your song. use it to control levels, pan, eq, compression and fx sends.

a good mix can make or break a song and subtle changes can make a big difference so try things out and see what sticks!

enter mix mode

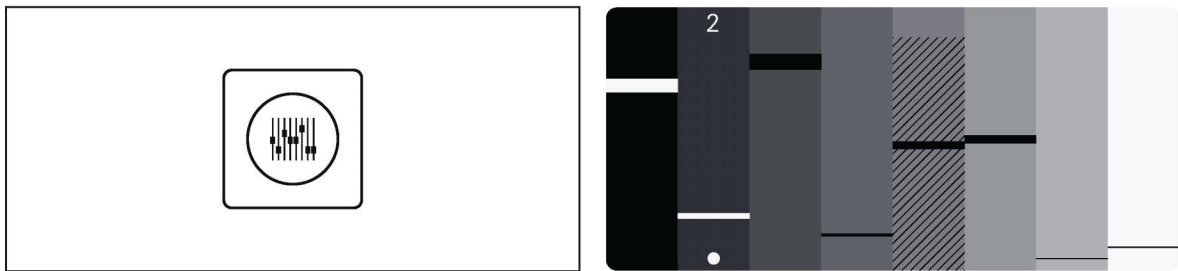

press mix to open mix mode.

17.1 levels, pans and sends

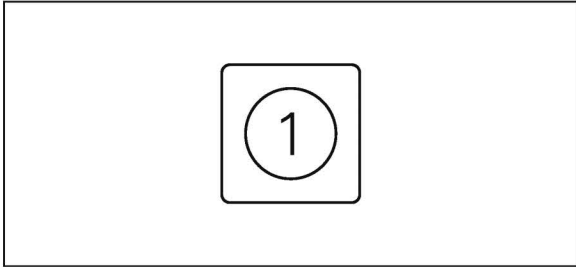

press M1 to view and edit the levels, pans and sends for each track.

switching tracks

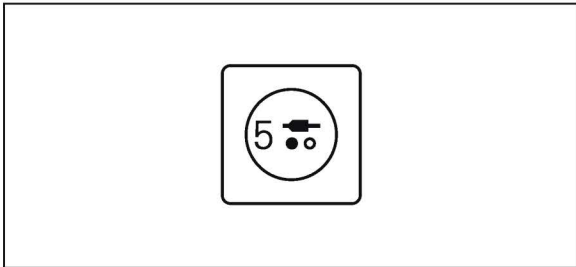

press the track button corresponding to the track you wish to mix.

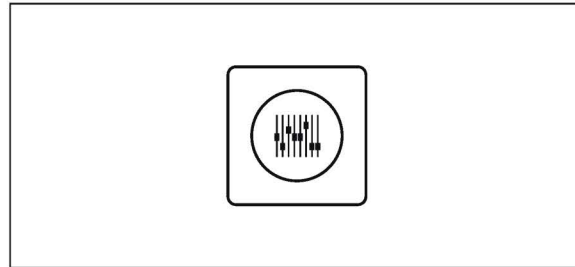

press mix while in mix mode to switch between instrument and auxiliary tracks. you can mix both instrument and auxiliary tracks.

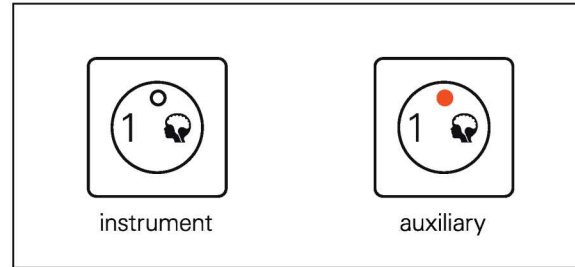

just as in any other mode, instrument tracks will light up in white and auxiliary in red, allowing you to quickly identify what tracks you are mixing.

FX I send

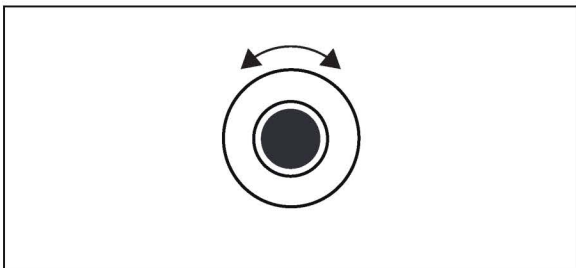

rotate the dark gray encoder to adjust the FX I send for the chosen track.

FX II send

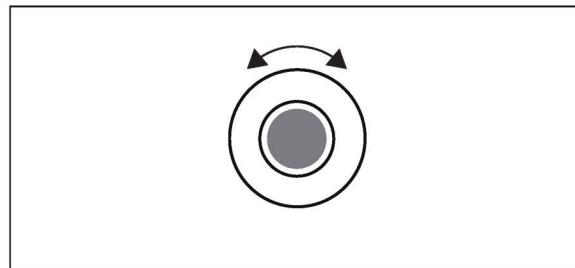

rotate the mid gray encoder to adjust the FX II send for the chosen track.

pan

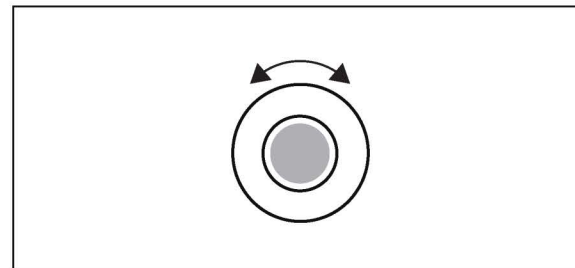

rotate the light gray encoder to adjust pan for the chosen track. press down on the encoder to reset the pan to center.

level

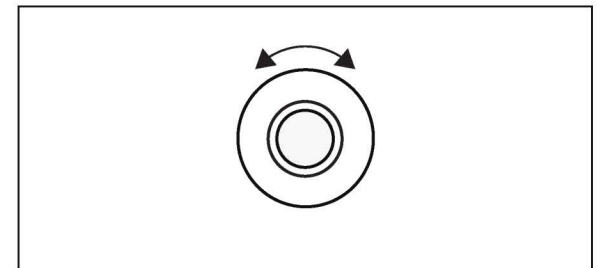

rotate the white encoder to adjust the level for the chosen track.

mute tracks

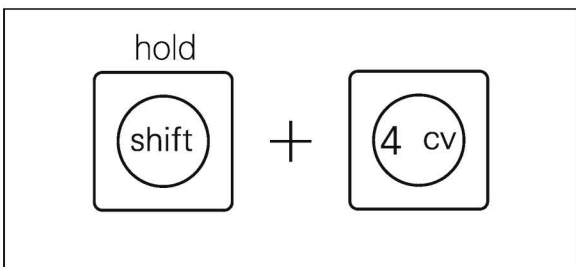

hold shift and press a track button to mute or unmute it. while holding shift, unmuted tracks will light up in white (for instrument) or red (for auxiliary) and muted tracks will be unlit. mutes affect notes and not audio.

mute track

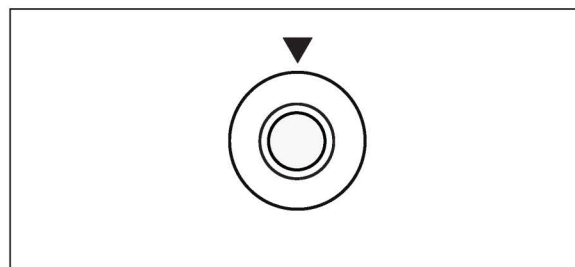

to mute the track you are currently editing you can alternatively press down the white encoder.

solo tracks

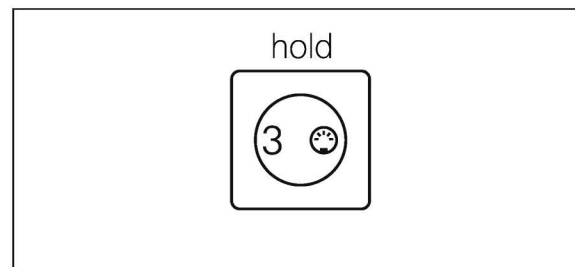

hold one, or multiple, track buttons while in mix to solo those tracks.

mute shortcut

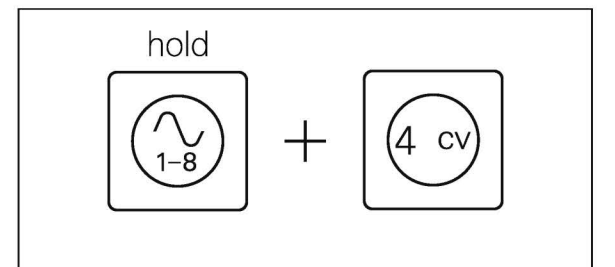

hold instrument or auxiliary and press a track button to quickly mute or unmute a track. if you hold instrument you will be able to mute instrument tracks, or auxiliary to mute auxiliary tracks.

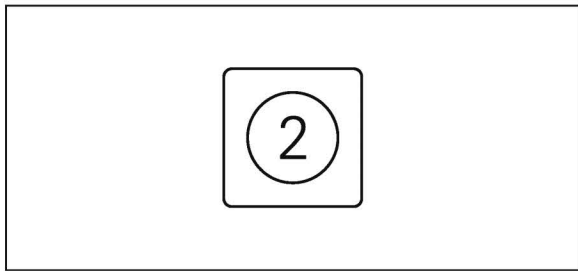

press M2 to adjust the master eq.

low

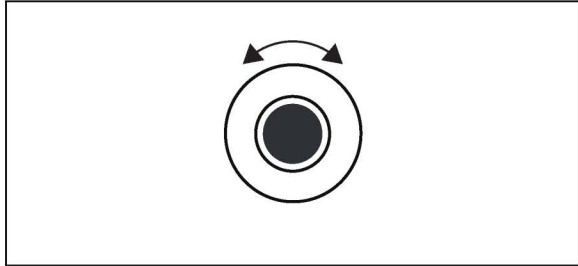

rotate the dark gray encoder to add or remove low frequencies. this is great for making basses more pronounced or taming bass that is too loud.

mid

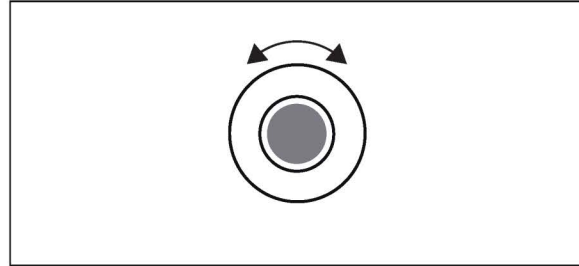

rotate the mid gray encoder to add or remove midrange frequencies.

high

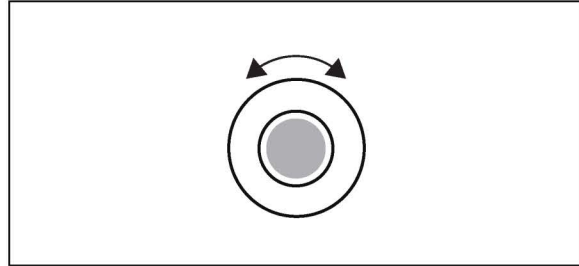

rotate the light gray encoder to add or remove high frequencies. use it to brighten or darken your sound.

blend

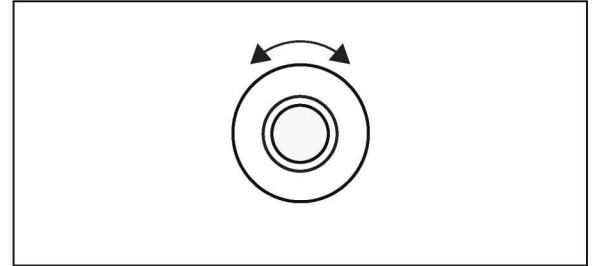

rotate the white encoder to blend between two eq settings. at lower settings the eq will always be neutral and at higher settings it will accentuate only the selected frequencies. this is perfect for performances where you want to quickly accentuate certain frequencies or do quick sweeps.

17.3 saturator

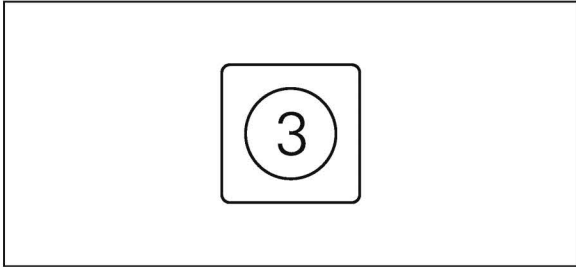

press M3 to adjust the master saturator.

gain

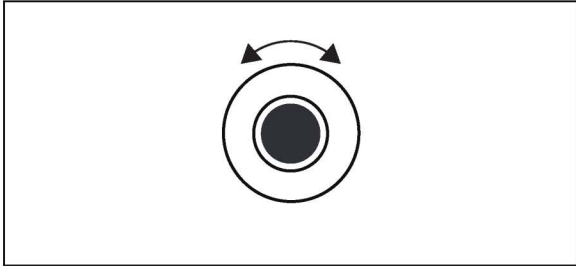

rotate the dark gray knob to adjust the gain into the saturator.

clip

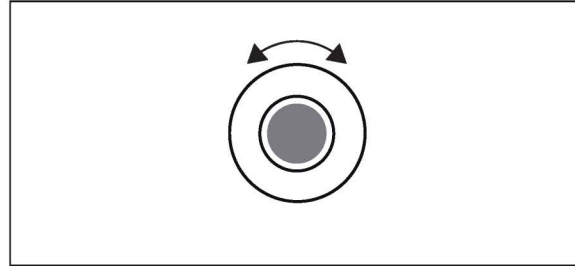

rotate the mid gray knob to adjust the clipping amount in the saturator, this will cut off loud dynamics.

tone

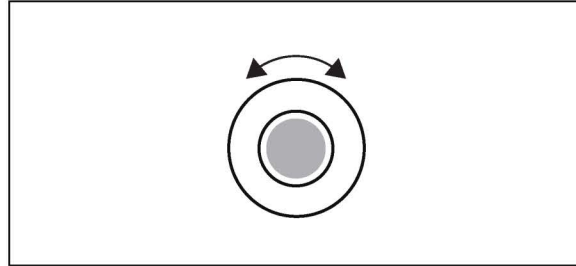

rotate the light gray knob to adjust the tone of the saturator, filtering high or low frequencies.

mix

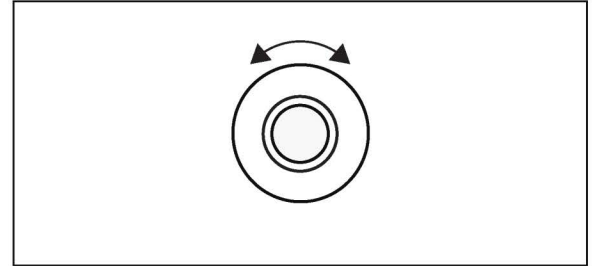

rotate the white knob to adjust the mix, how much you hear the saturator in the master mix.

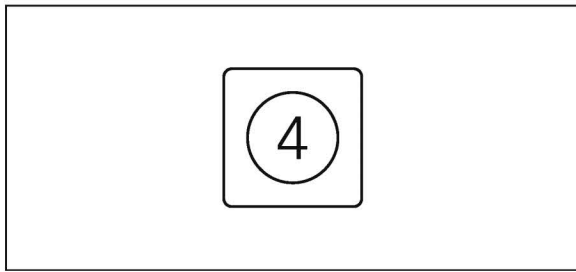

press M4 to adjust the master parameters in your project.

percussion

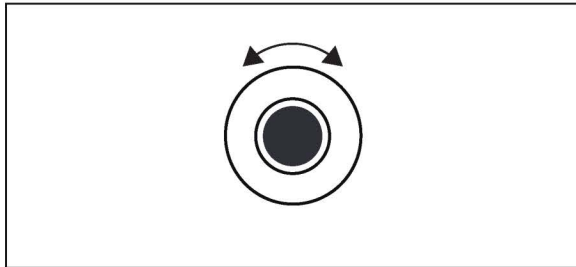

rotate the dark gray encoder to adjust the percussion group level. any percussive engines such as the drum sampler will automatically route through the percussion group.

melodic

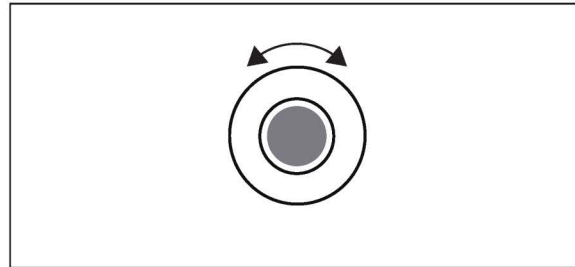

rotate the mid gray encoder to adjust the melodic group level. any melodic engines such as the synth engines and sampler will automatically route through the melodic group.

compressor

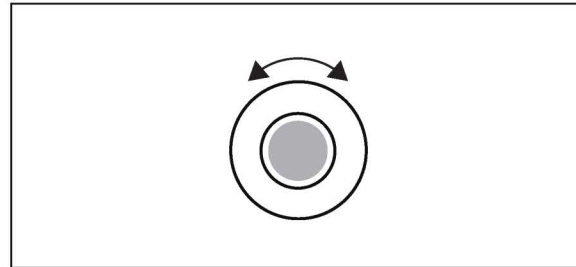

rotate the light gray encoder to add compression to the master bus. subtle compression can even out your mix by quietening loud sounds and boosting quiet ones. extreme compression can squash your whole mix and build a heavier, hard hitting sound.

master level

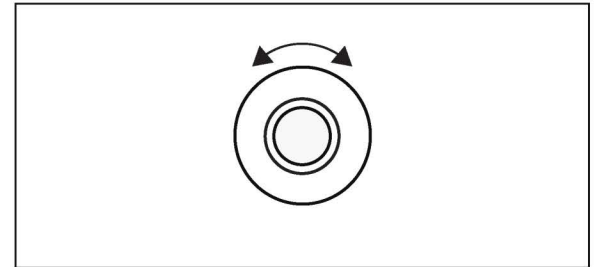

rotate the white encoder to boost the master level going into the output limiter.

17.5 signal flow diagram

note trig / signal path

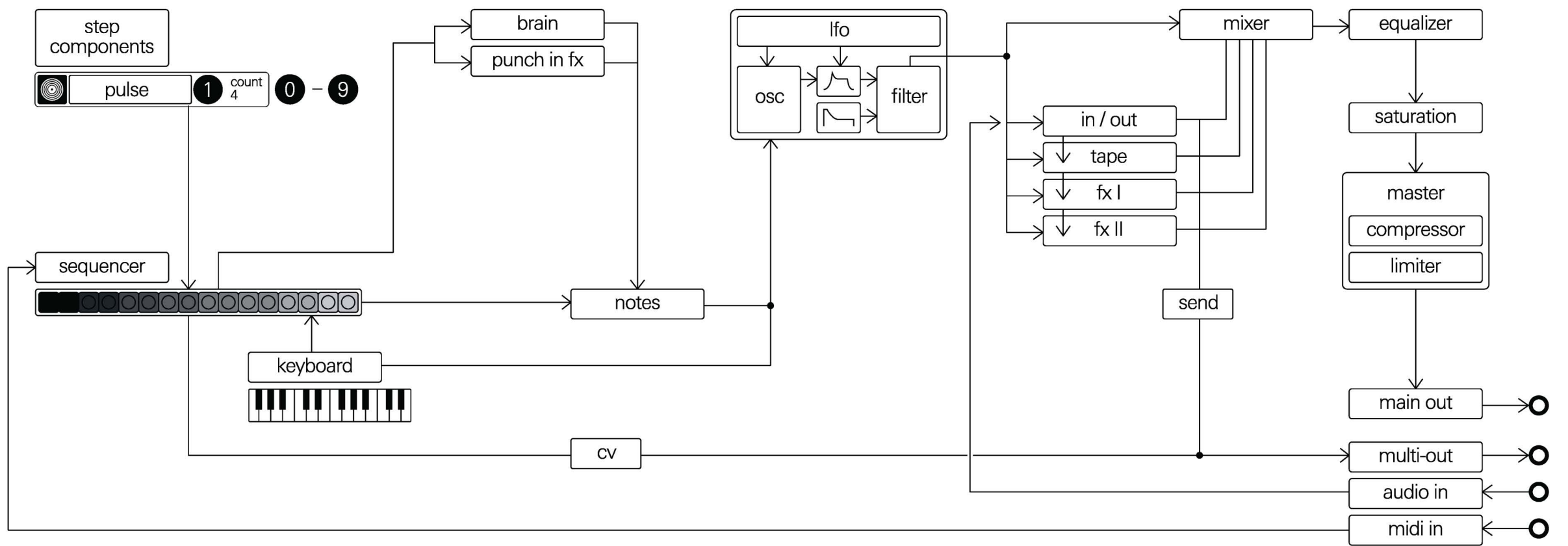

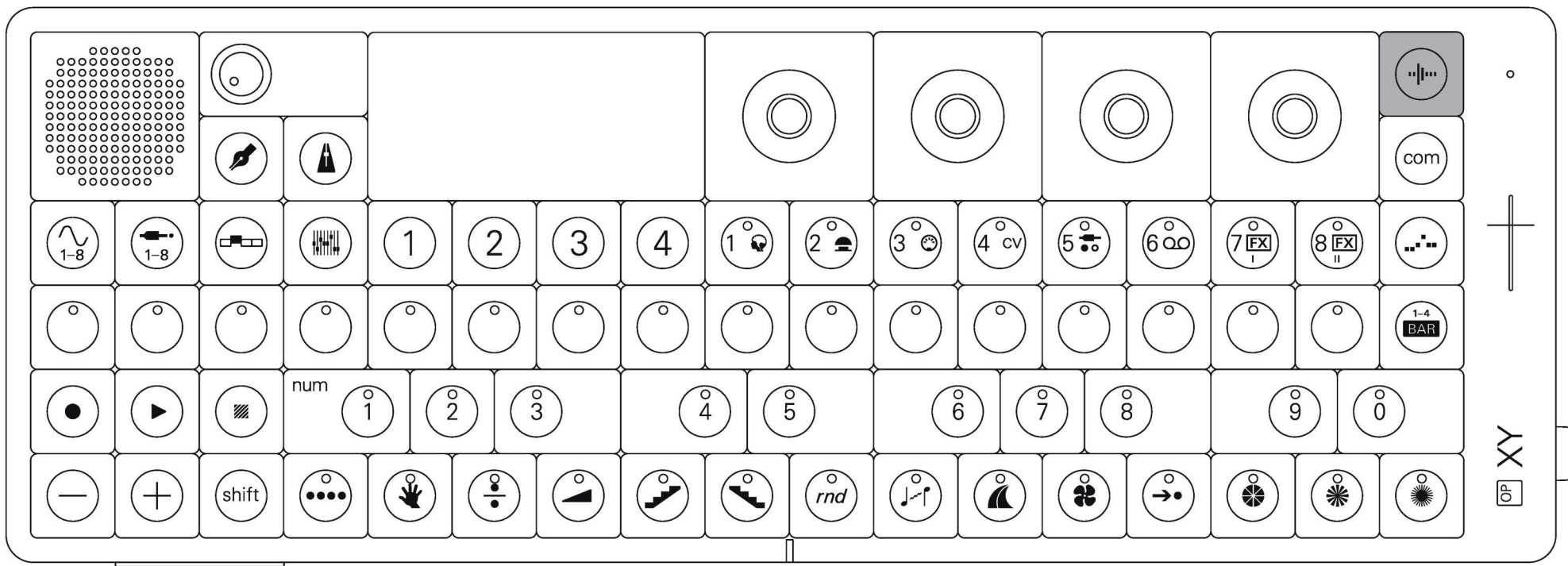

sampling is an amazing way to get new sounds into your OP-XY.

use the sample button to quickly record a sample or to record a new sample to an existing sampler track.

enter sample

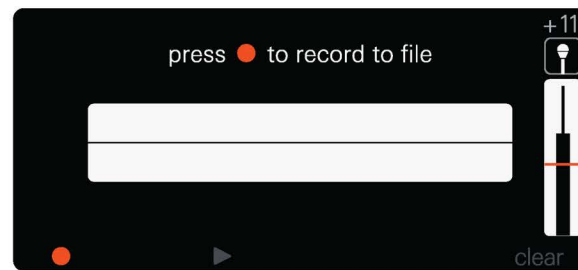
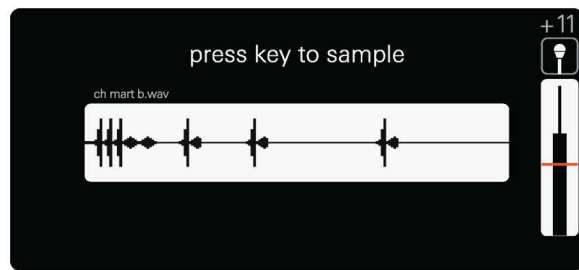
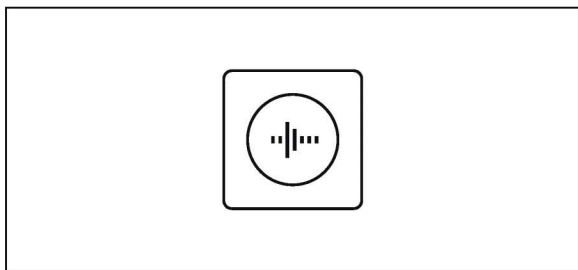

press sample while in any screen on the device to immediately sample something.

if you are already in a sample track the sample button will take you directly to the sample record page for the relevant sampler engine.

if you are not already in a sample track, the sample button will allow you to quickly record a sample and save it to the sample folder. for use later.

for all samplers, samples can be a maximum of 20 seconds in length.

record

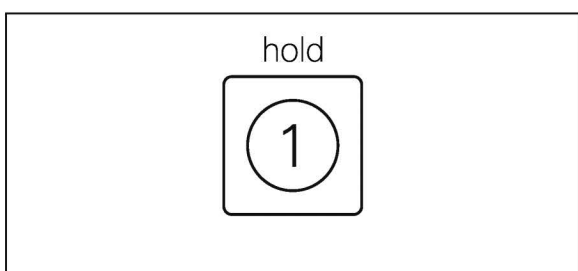

hold M1 to start recording a sample. sampling will only commence once the input source crosses the sampling threshold.

play

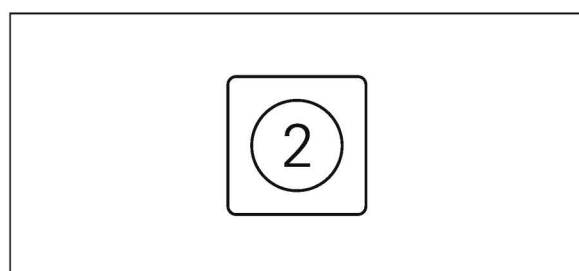

press M2 to listen to the recorded sample.

delete

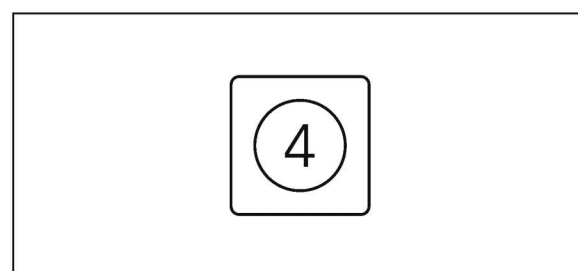

press M4 to delete the recorded sample, preventing it saving to the sample folder.

exit

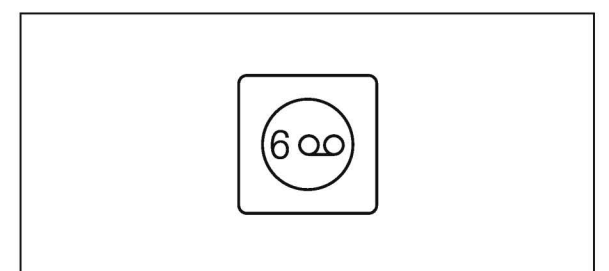

press the currently highlighted track button to exit sample mode.

source

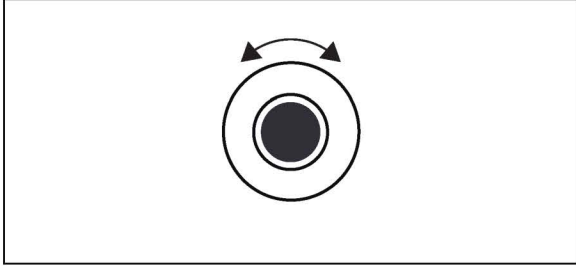

rotate the dark grey knob to select the input source for sampling.

gain

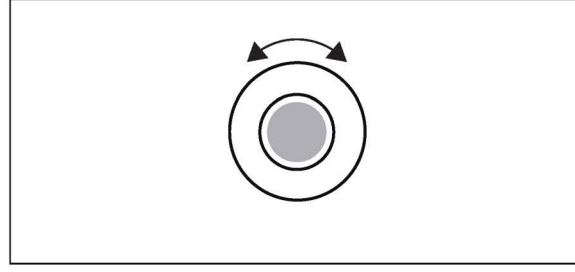

rotate the light grey knob to adjust the gain of the audio being recorded. you can see a live preview of the level on the vu meter.

threshold

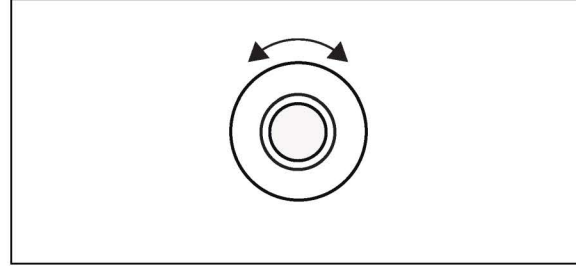

rotate the white knob to adjust the sample record threshold. this is the level after which the sampler will begin recording.

18.1 one shot synth sampler

the one shot sampler allows you to quickly record a sample and get an idea down.

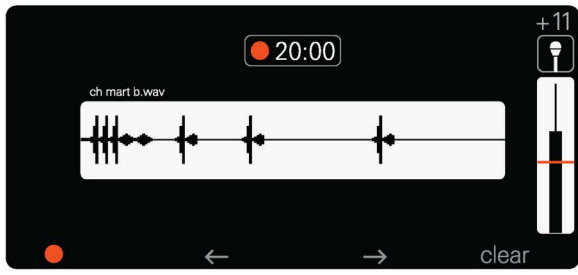

source

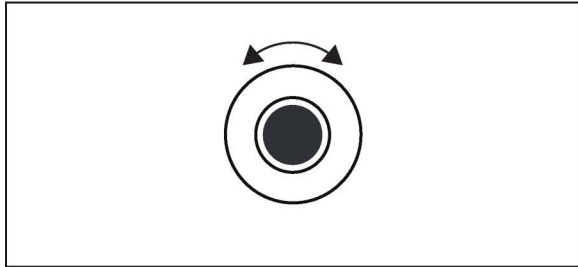

rotate the dark grey knob to select the input source for sampling.

gain

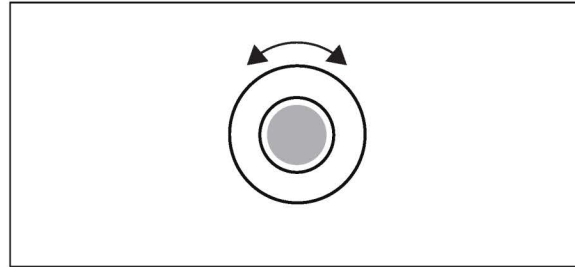

rotate the light grey knob to adjust the gain of the audio being recorded. you can see a live preview of the level on the vu meter.

threshold

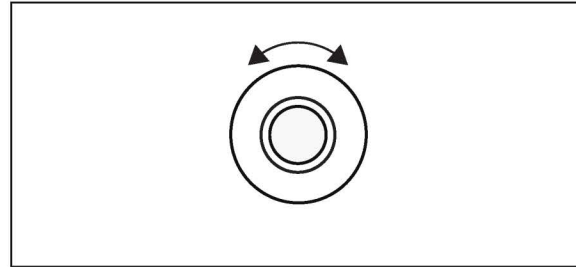

rotate the white knob to adjust the sample record threshold. this is the level after which the sampler will begin recording.

start sampling

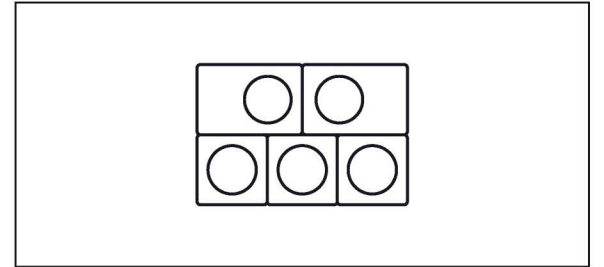

press any key to start sampling. the key you select will be the note that the sampler tunes the sample to.

editing screen

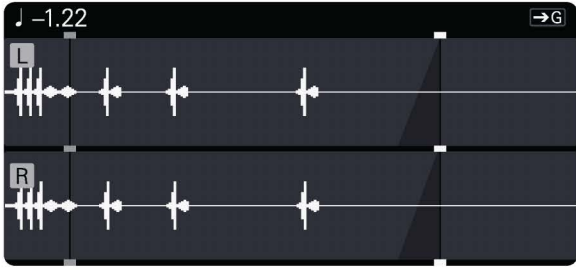

sample start

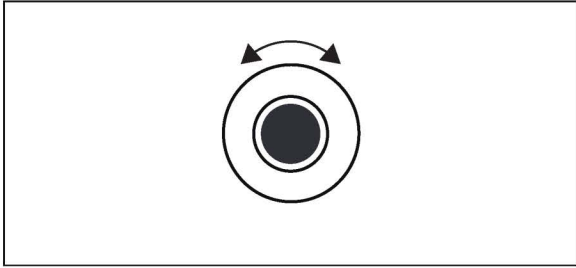

rotate the dark grey knob to adjust the sample start point. you can click the knob down to make a finer adjustment.

loop start

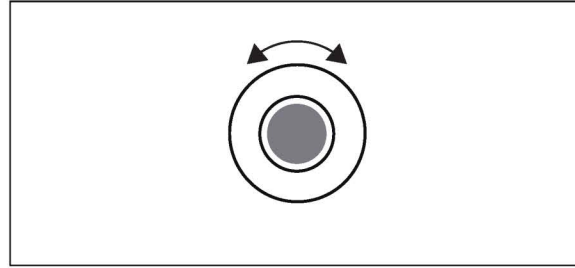

rotate the mid grey knob to adjust the loop start point. set it to the end of the sample to have no loop. you can click the knob down to make a finer adjustment.

loop end

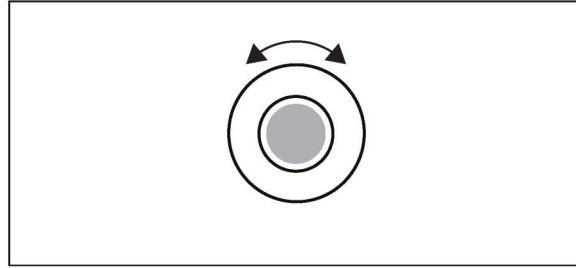

rotate the light grey knob to adjust the loop end point. you can click the knob down to make a finer adjustment.

sample end

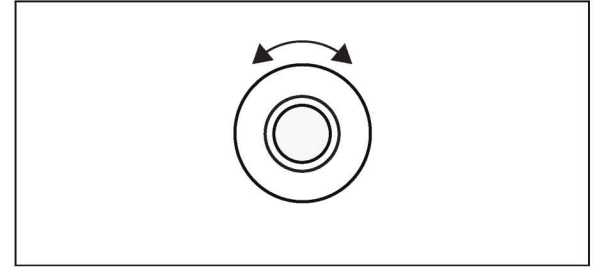

rotate the white knob to adjust the sample end point. you can click the knob down to make a finer adjustment.

sample direction

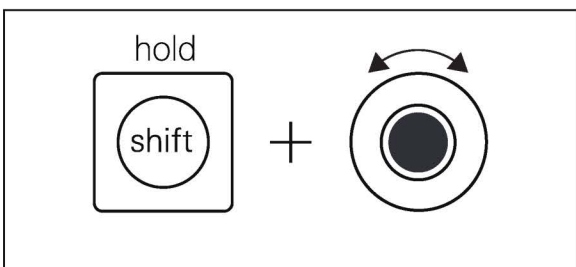

hold shift and rotate the dark grey knob to select the sample playback direction between forwards and backwards.

tune

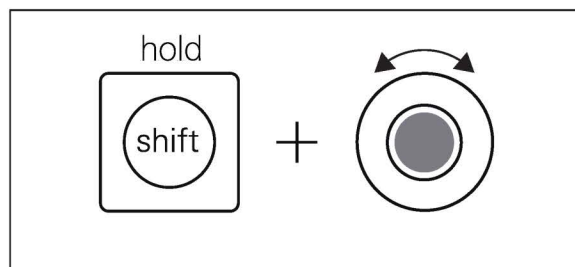

hold shift and rotate the mid grey knob to adjust the tuning of the sample.

loop crossfade

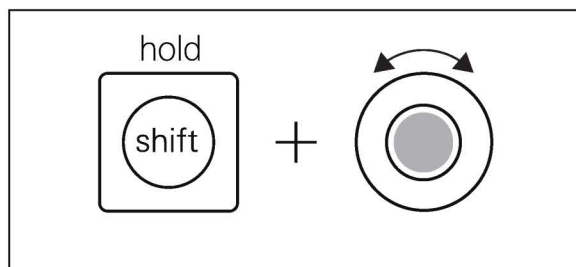

hold shift and rotate the light grey knob to adjust the loop crossfade amount, use this to create smooth pads.

sample gain

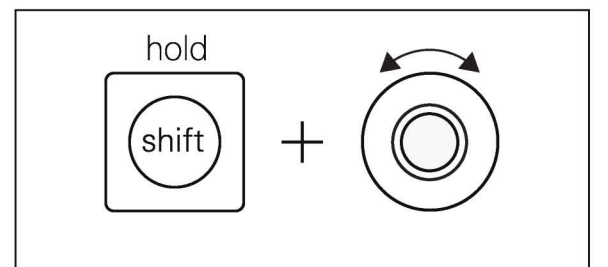

hold shift and rotate the white knob to adjust the sample gain.

18.2 drum sampler

the drum sampler allows you to trigger 24 different one shot samples across the musical keyboard. perfect for drums but also great for triggering other sounds.

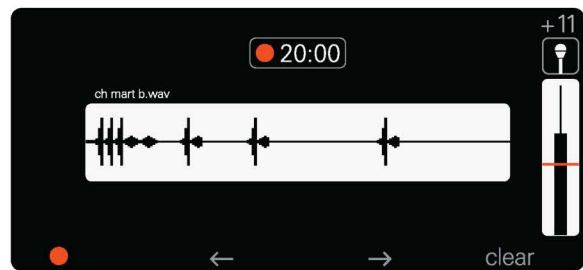

source

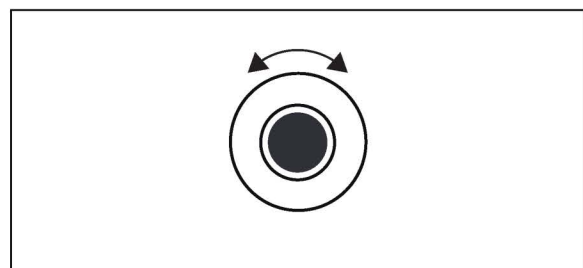

rotate the dark grey knob to select the input source for sampling.

gain

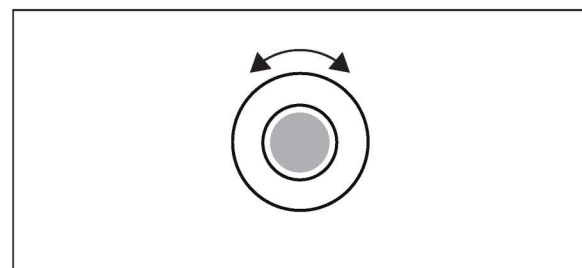

rotate the light grey knob to adjust the gain of the audio being recorded. you can see a live preview of the level on the vu meter.

threshold

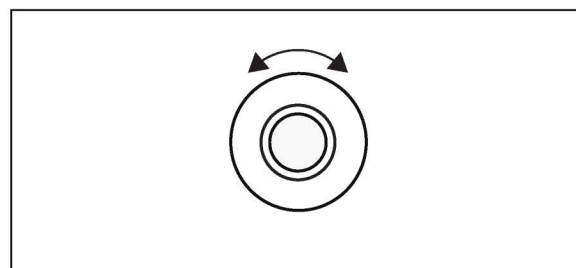

rotate the white knob to adjust the sample record threshold. this is the level after which the sampler will begin recording.

key select

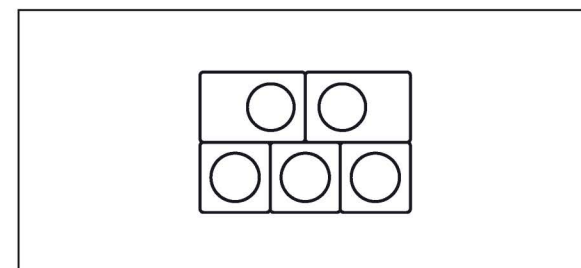

press a key to select it, it will light up and you can then record a sample to it.

record sample

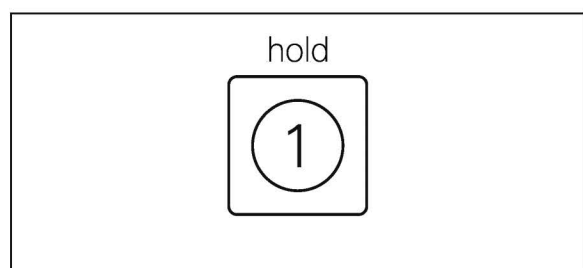

hold M1 to record a sample to the selected key. recorded samples will automatically save to the user sample folder on the device.

previous sample

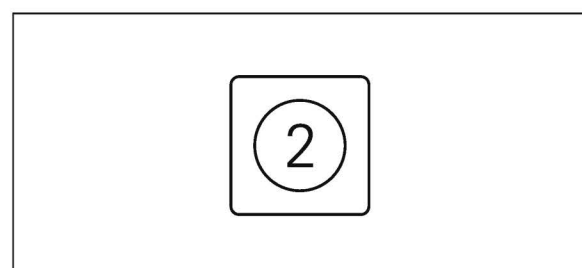

press M2 to move to the previous recorded key and sample. this will only move you through keys that have samples recorded to them.

next sample

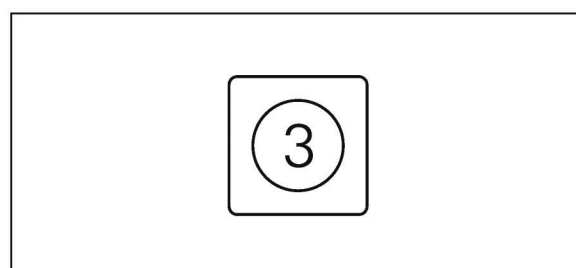

press M3 to move to the next recorded key and sample. this will only move you through keys that have samples recorded to them.

clear

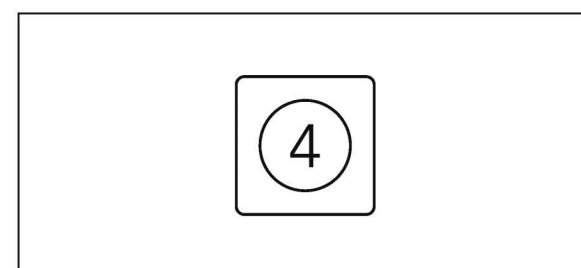

press M4 to clear a sample from a key. all recorded samples will be automatically saved to the user sample folder so clear will only remove the assignment, not delete the sample outright.

editing screen

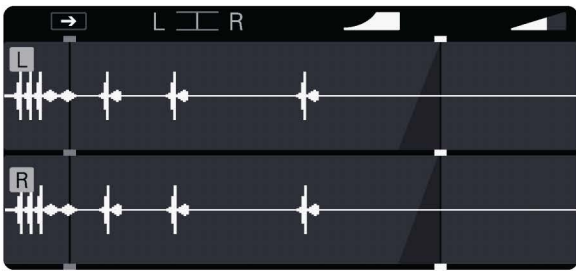

tune

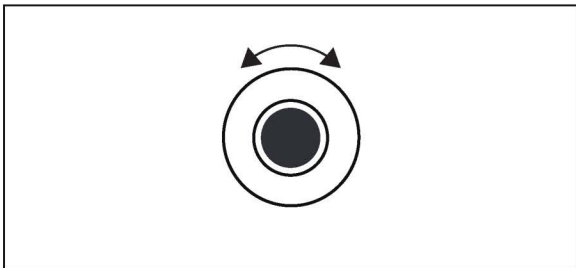

rotate the dark grey knob to adjust the tuning of the selected key and sample.

sample start

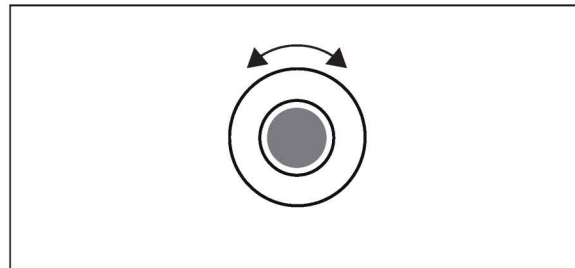

rotate the mid grey knob to adjust the sample start point. you can click the knob down to make a finer adjustment.

sample end

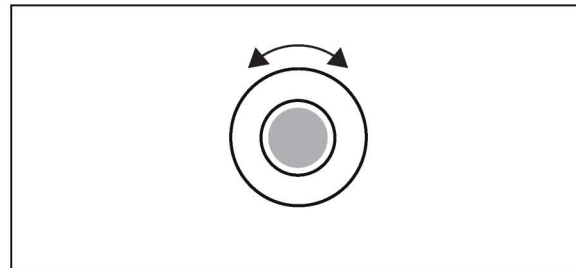

rotate the light grey knob to adjust the sample end point. you can click the knob down to make a finer adjustment.

play mode

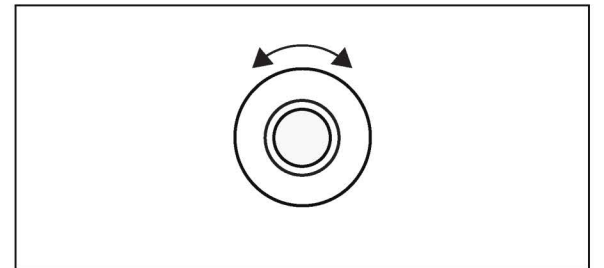

rotate the white knob to adjust the sample playback style, here you can select from:

- key (play while held)
- oneshot (play whole sample)
- mute group (choke when another sample plays)
- loop (loop at sample end)

sample direction

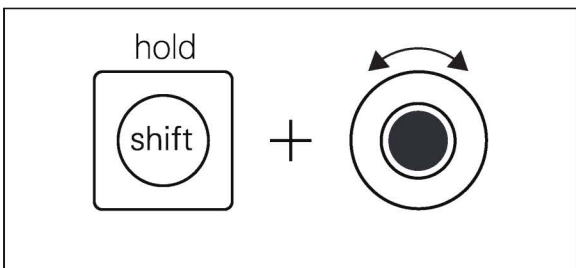

hold shift and rotate the dark grey knob to select the sample playback direction between forwards and backwards.

pan

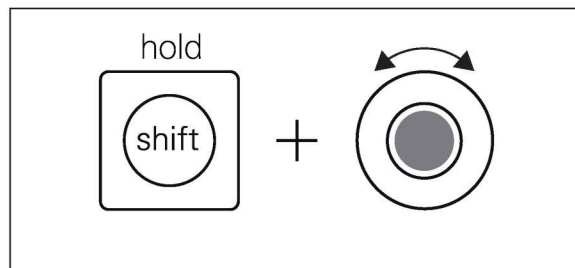

hold shift and rotate the mid grey knob to adjust the panning of the sample.

sample fade

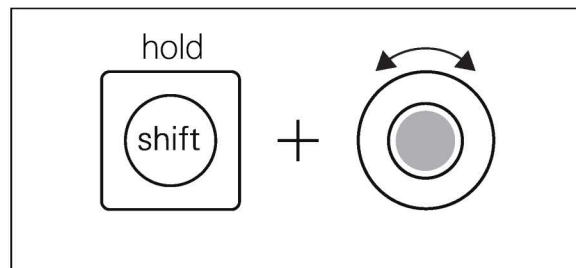

hold shift and rotate the light grey knob to adjust the sample start fade.

sample gain

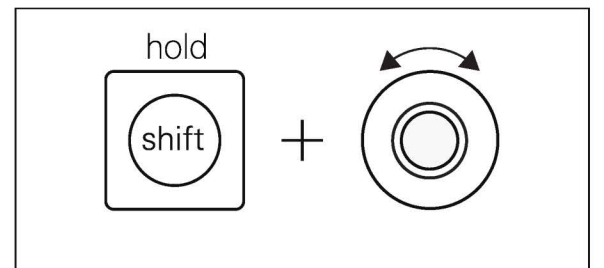

hold shift and rotate the white knob to adjust the sample gain.

18.3 multisampler

the multisampler allows you to record more complex and accurate samples of your instruments.

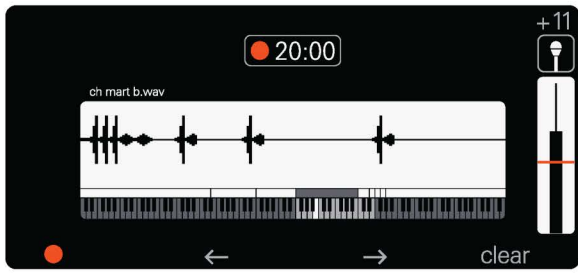

source

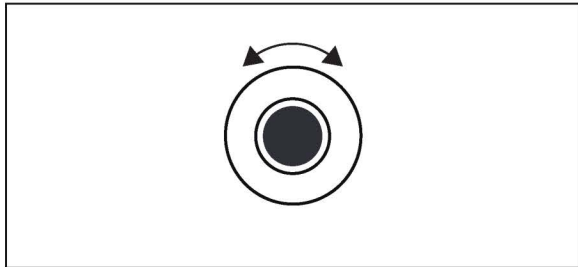

rotate the dark grey knob to select the input source for sampling.

gain

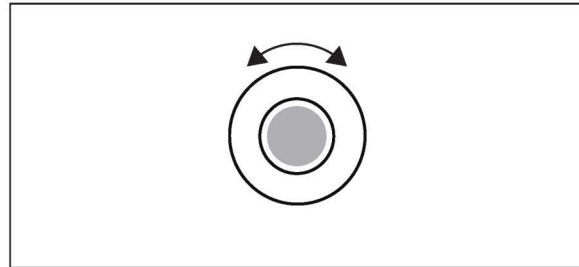

rotate the light grey knob to adjust the gain of the audio being recorded. you can see a live preview of the level on the vu meter.

threshold

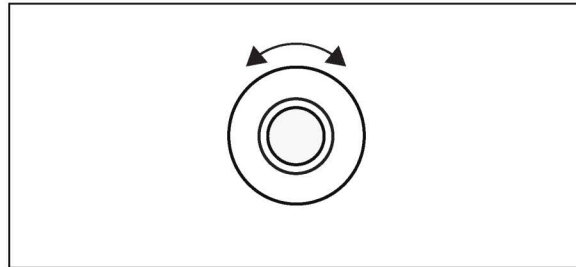

rotate the white knob to adjust the sample record threshold. this is the level after which the sampler will begin recording.

key select

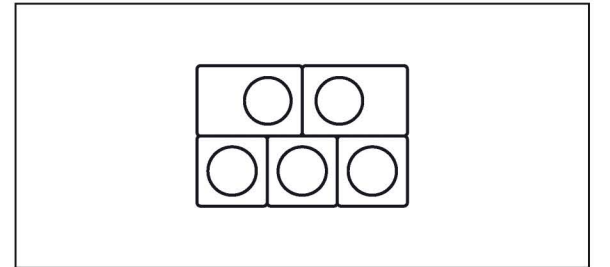

press a key to select it, it will light up and you can then record a sample to it. as you select keys from left to right OP-XY will automatically create zones for those samples. the multisampler fills down so as you add samples it will fill the gaps by pitching those samples down.

record sample

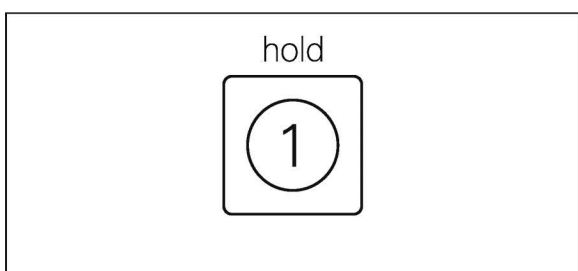

hold M1 to record a sample to the selected key. recorded samples will automatically save to the user sample folder on the device.

previous sample

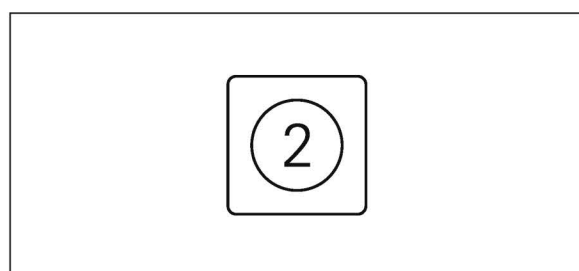

press M2 to move to the previous recorded key and sample. this will only move you through keys that have samples recorded to them.

next sample

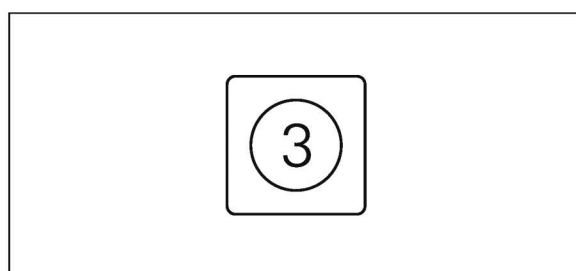

press M3 to move to the next recorded key and sample. this will only move you through keys that have samples recorded to them.

clear

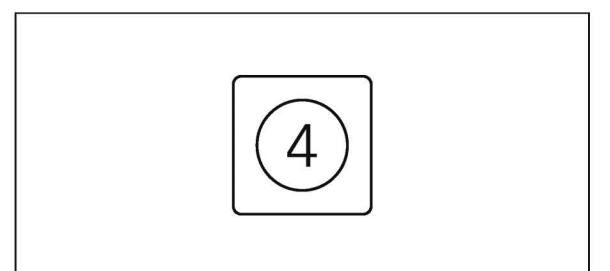

press M4 to clear a sample from a key. all recorded samples will be automatically saved to the user sample folder so clear will only remove the assignment, not delete the sample outright.

max zones



the multisampler holds a maximum of 24 zones. enough for around 3 samples per octave.

editing screen

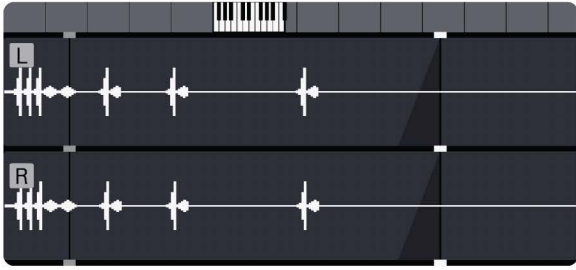

sample start

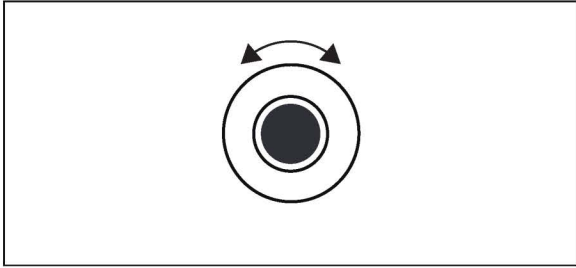

rotate the dark grey knob to adjust the sample start point. you can click the knob down to make a finer adjustment.

loop start

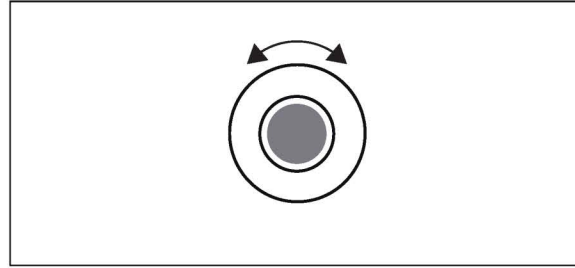

rotate the mid grey knob to adjust the loop start point. set it to the end of the sample to have no loop. you can click the knob down to make a finer adjustment.

loop end

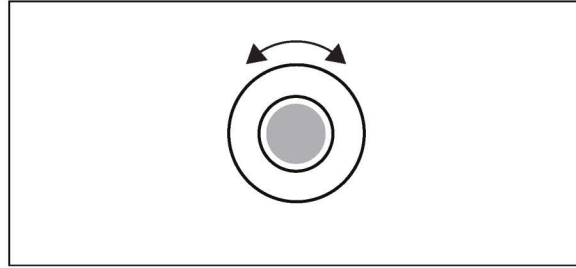

rotate the light grey knob to adjust the loop end point. you can click the knob down to make a finer adjustment.

sample end

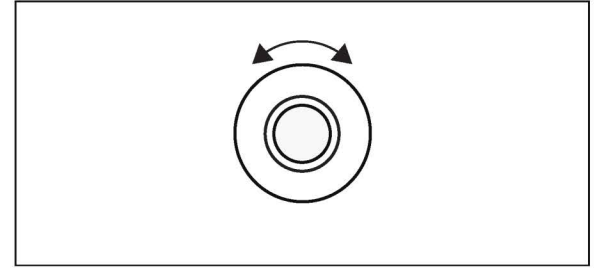

rotate the white knob to adjust the sample end point. you can click the knob down to make a finer adjustment.

sample direction

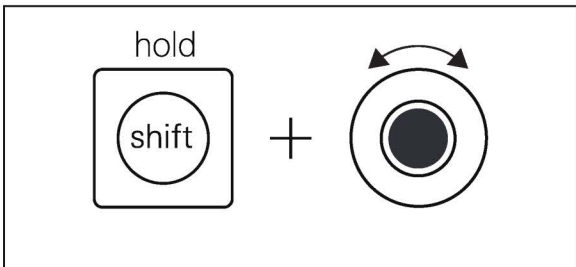

hold shift and rotate the dark grey knob to select the sample playback direction between forwards and backwards.

tune

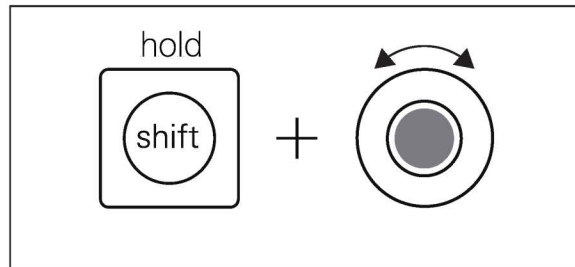

hold shift and rotate the mid grey knob to adjust the tuning of the sample.

loop crossfade

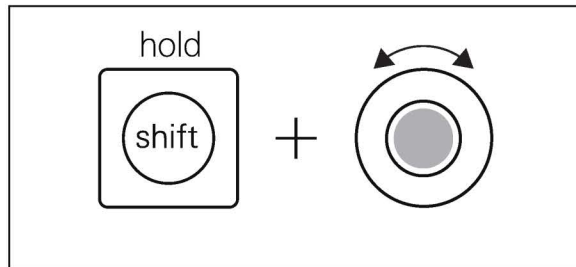

hold shift and rotate the light grey knob to adjust the loop crossfade amount, use this to create smooth pads.

sample gain

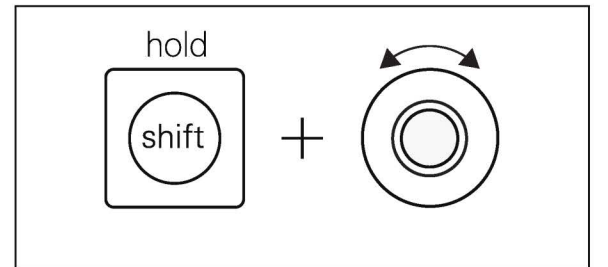

hold shift and rotate the white knob to adjust the sample gain.

18.4 sample folder

OP-XY stores all of your samples in the sample folder. you can use the sample folder to load any sample into any of the samplers.

think of the sample folder as a place to hold all of your favourite samples. you can pick out whichever one you like, whenever you need it and use it in your project.

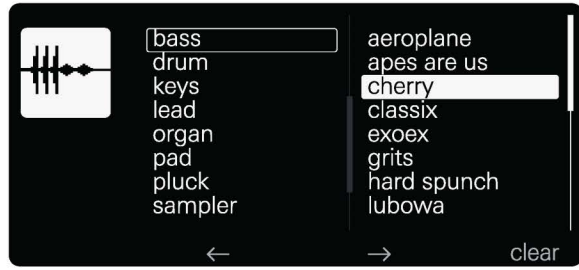

open sample folder

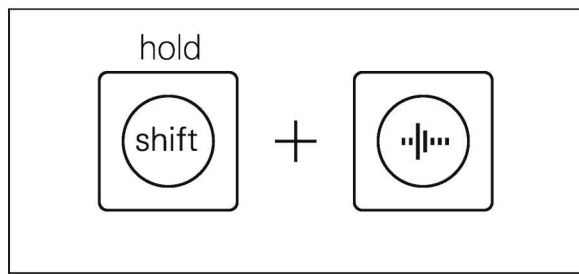

hold shift and press sample to open the sample folder.

type

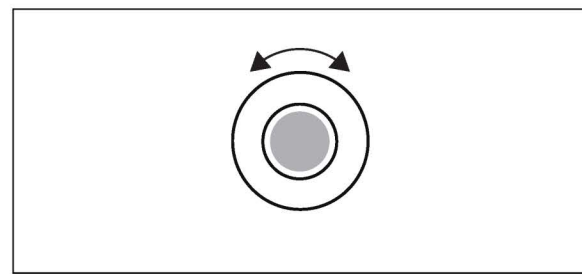

rotate the dark grey knob to select the sample type, you can create a new type in the mtp mode by creating and naming a folder in the samples folder.

sample select

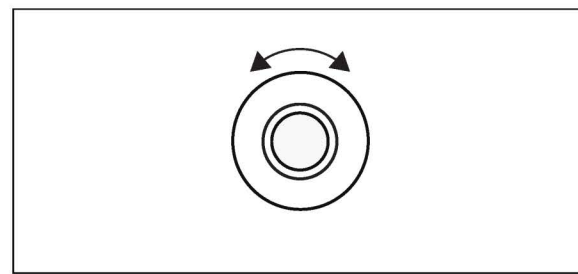

rotate the mid grey, light grey or white knobs to select a sample.

arrows and clear



in the drum sampler and multisampler you will see some additional controls on screen.

previous sample

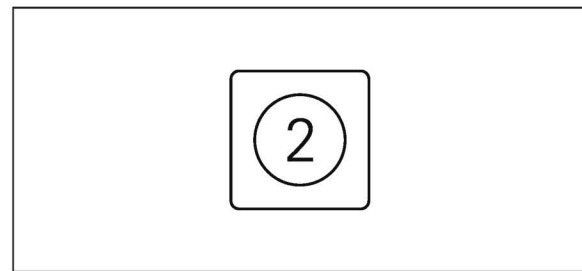

press M2 to move to the previous recorded key and sample. this will only move you through keys that have samples recorded to them.

next sample

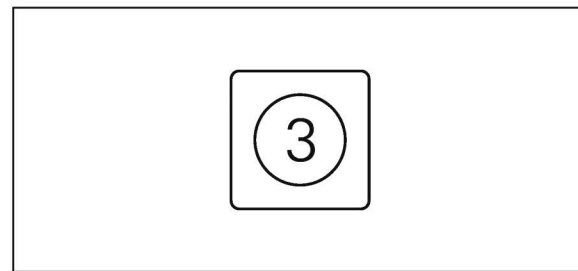

press M3 to move to the next recorded key and sample. this will only move you through keys that have samples recorded to them.

clear

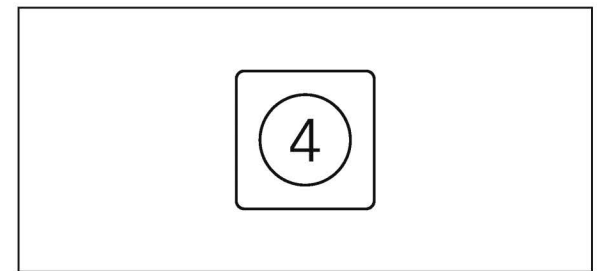

press M4 to clear a sample from a key. all recorded samples will be automatically saved to the user sample folder so clear will only remove the assignment, not delete the sample outright.

delete a sample

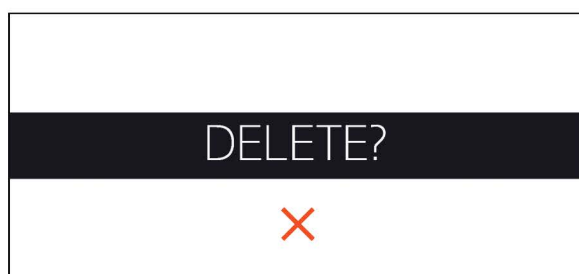

to delete a sample from the device permanently you will have to connect the device to a computer and use mtp to delete the file off the device.

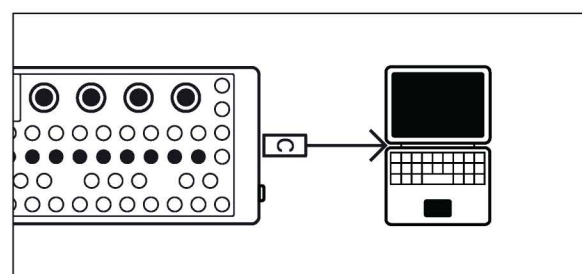

OP-XY supports both aiff and wav files, you can load these onto the device by connecting it to a computer and copying the files to the sample folder.

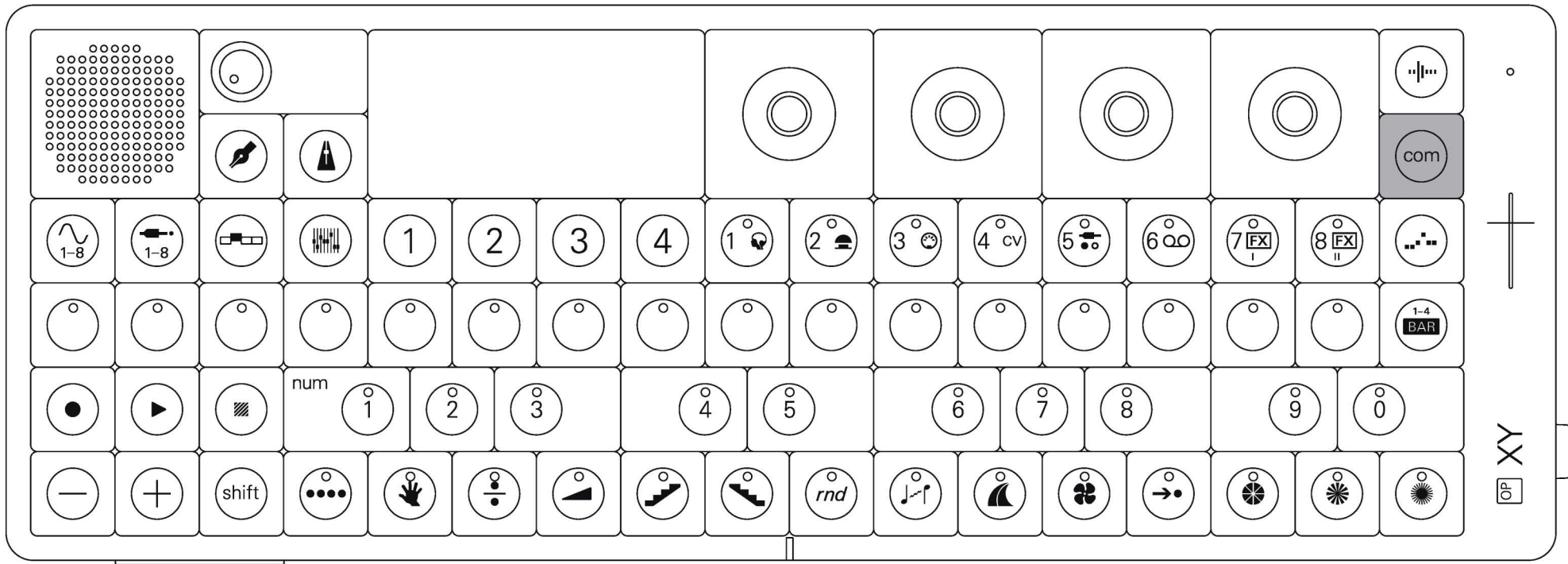

com is where you adjust system settings, use OP-XY as a midi controller, back up your data and select the function of the multi-out port.

enter com

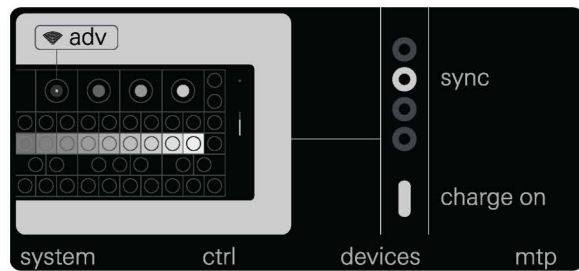
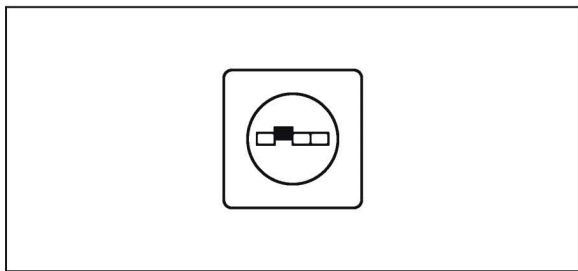

press com to enter com.

system

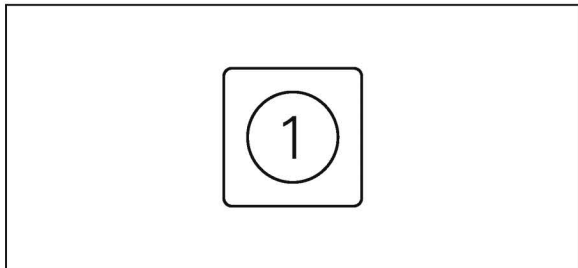

press M1 to enter system settings.

ctrl

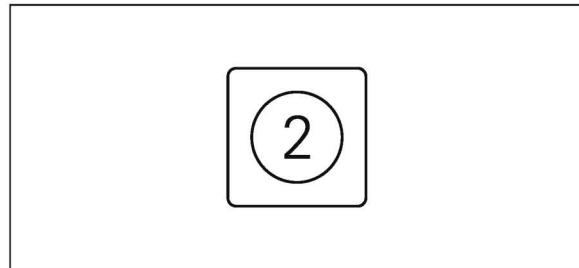

press M2 to enter midi controller mode. this turns OP-XY into a midi controller.

devices

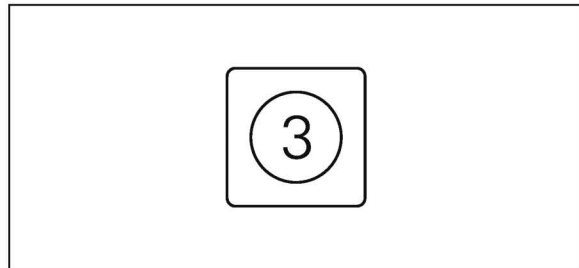

press M3 to view midi devices that are connected to the OP-XY.

mtp

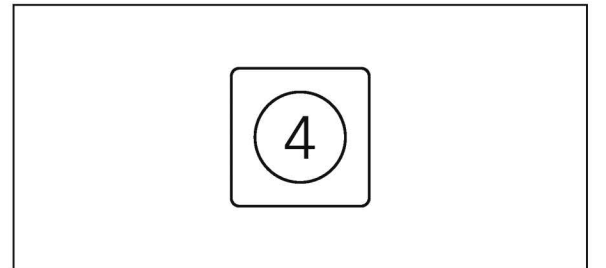

press M4 to put OP-XY into MTP mode, this is where you can back up your samples, presets and projects.

19.1 setting the multi-out port and bluetooth midi

the multi-out port allows you to connect your OP-XY to almost any other piece of music equipment, controlling, sequencing or syncing to them. bluetooth midi similarly allows you to control other compatible devices, without the wires.

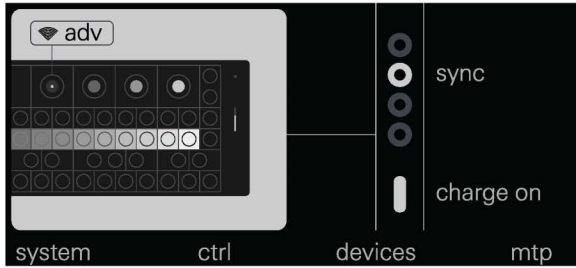

bluetooth midi

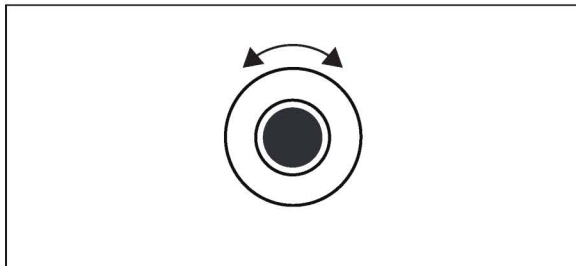

rotate or click the dark gray knob to advertise OP-XY on bluetooth midi. this allows you to connect it as a device to another device (host).

multi-out

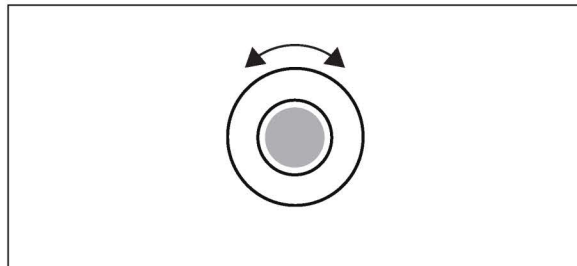

rotate the light gray knob to edit the output of the multi-out port. you can choose between:
midi
cv/gate
sync8
sync16
sync24
audio

multi-out cannot be changed while plugged in.

19.2 system settings

system settings allow you to adjust everything from screen brightness to keyboard velocity and midi preferences.

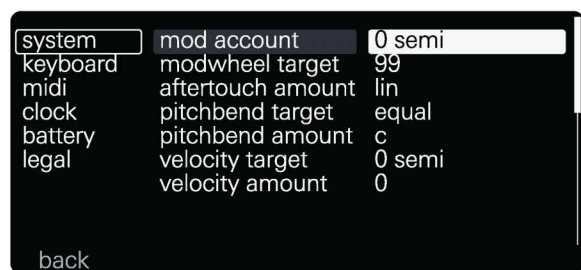

section

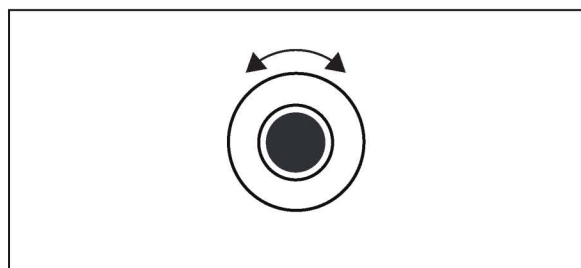

rotate the dark gray knob to select the section of the device you wish to edit.

setting

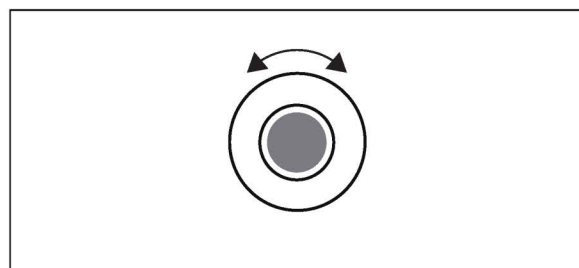

rotate the mid gray knob to select the setting you wish to edit.

value

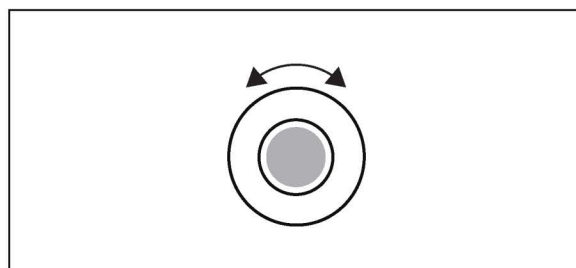

rotate the light gray knob to adjust the value of the selected setting. the white knob can also be used.

exit

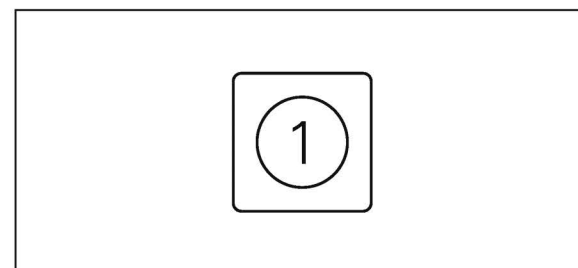

press M1 to exit the system settings and return to com.

system

the system settings page in system settings allows you to adjust screen brightness, led brightness, country and power off type (instant or delayed, to prevent accidental power-offs while performing or composing).

keyboard

the keyboard settings page in system settings allows you to adjust the velocity response of the built-in keyboard, as well as detune the keys by both notes and cents, for microtonal scales.

midi

the midi settings page in system settings allows you to set how midi clock, notes and other midi messages are sent and received, as well as selecting the active track channel (the active track is the one currently selected) and midi echo.

clock

the clock settings page in system settings allows you to set the clock of the device, this will update the date and time of any snapshots, autosaves, versions and everything else in the device.

battery

the battery settings page in system settings allows you to view the current battery level and input current limit.

19.3 midi controller mode

midi controller mode allows you to use OP–XY as a generic midi controller for any device, such as a computer.

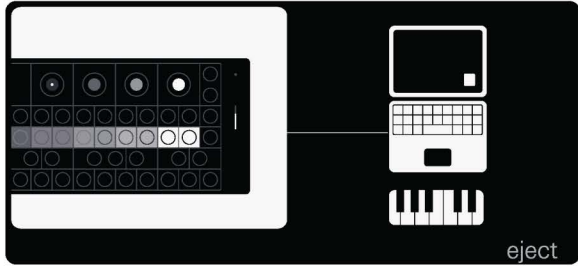

channel

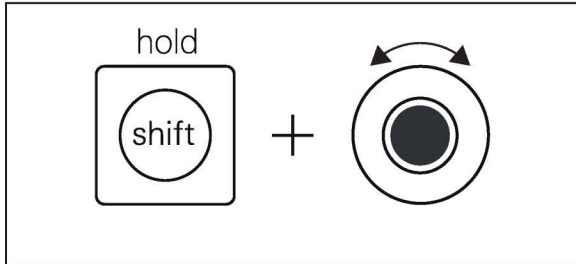

hold shift and rotate the dark gray knob to adjust the midi channel OP–XY outputs while in control mode.

knobs

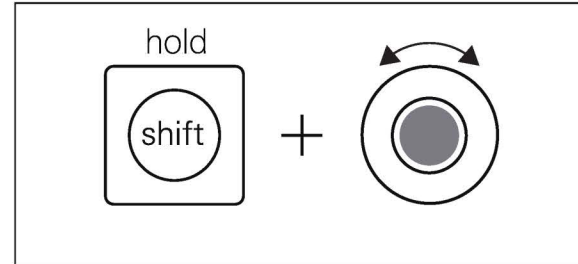

hold shift and rotate the mid gray knob to change the knob behavior between absolute and relative. absolute behaves as a knob going from 0–127, whereas relative sends the difference from the last knob position.

octave

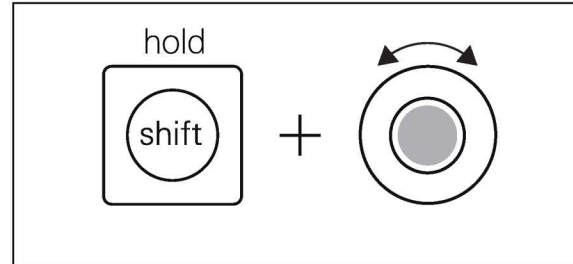

hold shift and rotate the mid gray knob to enable or disable the (-) and (+) octave buttons.

exit

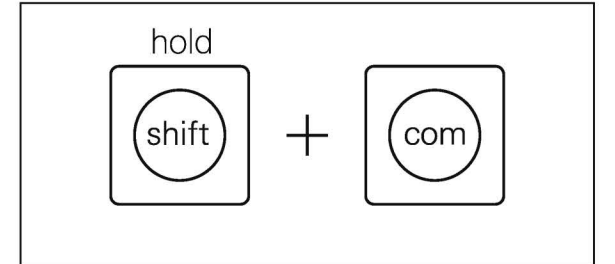

hold shift and press com to exit midi controller mode and return to com.

19.4 devices

devices allows you to view and edit the connected midi devices, enabling and disabling various inputs and outputs from and to those devices.

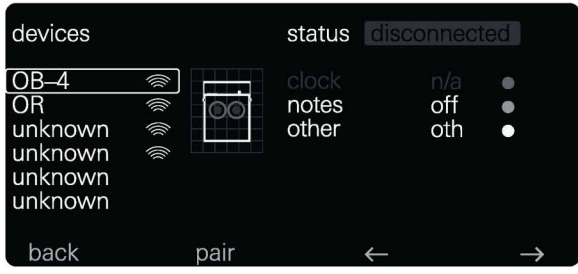

back

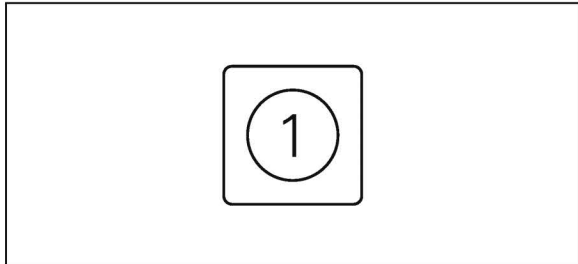

press M1 to exit devices and return to com.

forget

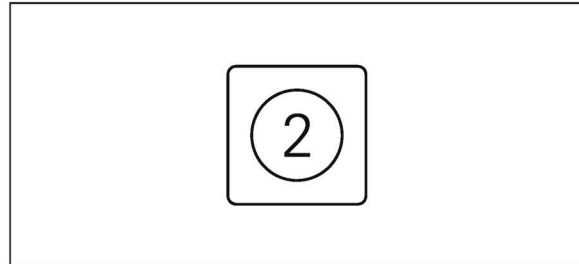

press M2 to forget the currently selected device. this will remove it from your list of devices.

page 1

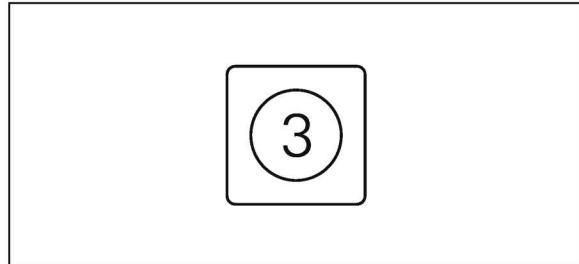

press M3 to view and edit page 1 of the midi device settings. these settings include how clock, notes and other are sent and received.

page 2

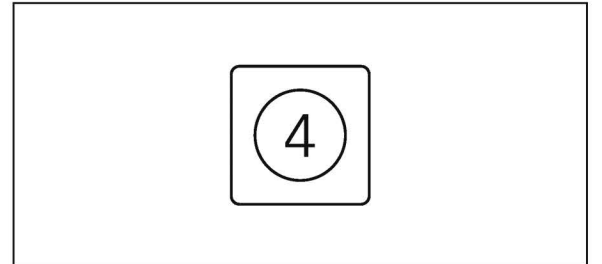

press M4 to view and edit page 2 of the midi device settings. these settings include whether timestamp and velocity are sent or not.

page 1

device

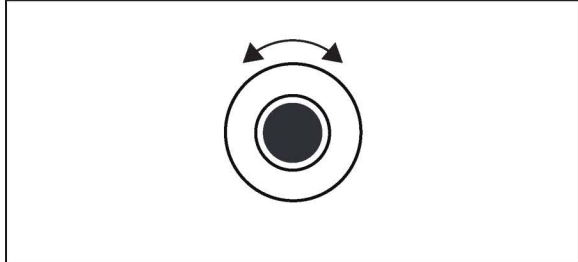

rotate the dark gray knob to select a device to edit.

clock

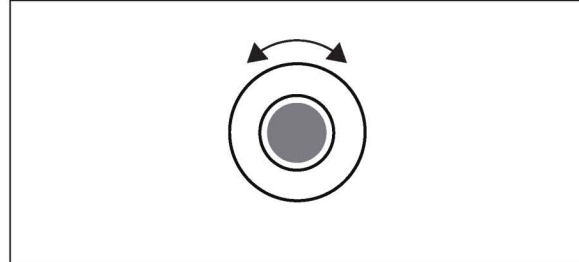

rotate the mid gray knob to edit how clock is sent and received.

notes

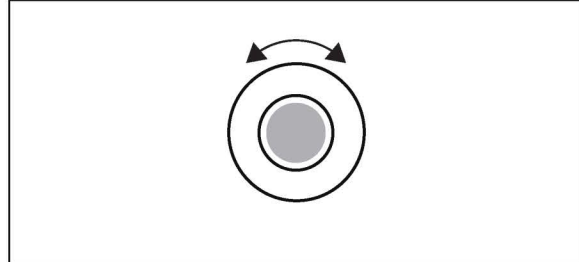

rotate the light gray knob to edit how notes are sent and received.

other

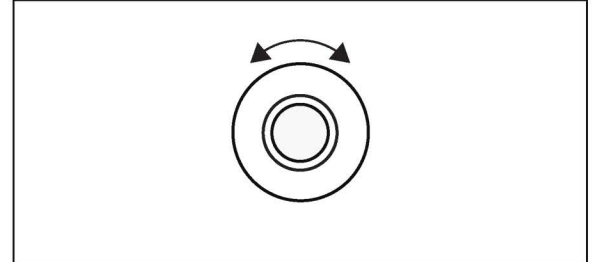

rotate the white knob to edit how other midi parameters are sent and received. other mostly refers to midi CCs.

page 2

device

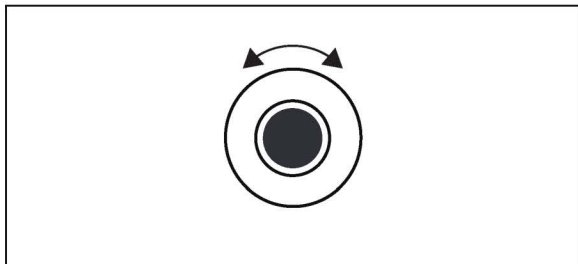

rotate the dark gray knob to select a device to edit.

timestamp

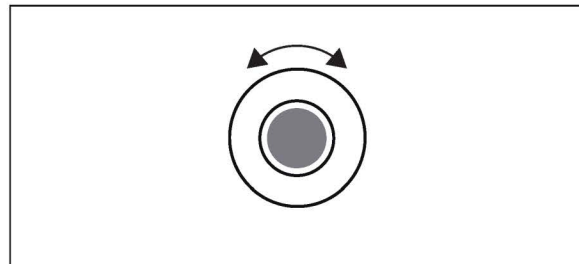

rotate the mid gray knob to select whether timestamp is sent or not.

velocity

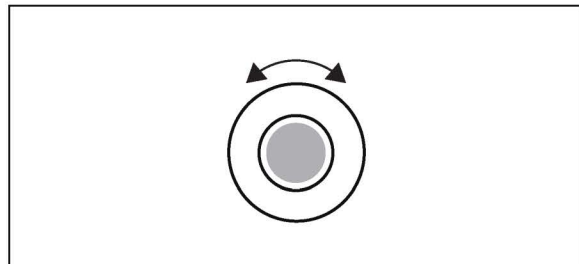

rotate the light gray knob to select whether velocity is sent or not.

19.5 mtp

mtp is where you can connect to a computer to add samples, presets and projects. you will need to connect your OP–XY to a computer before you can enter mtp mode.

mtp refers to 'media transfer protocol' and is a super fast way to transfer files between devices. when using a mac you will need to download the [fieldkit app](#).

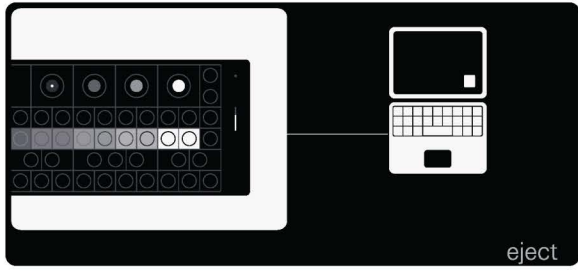

eject

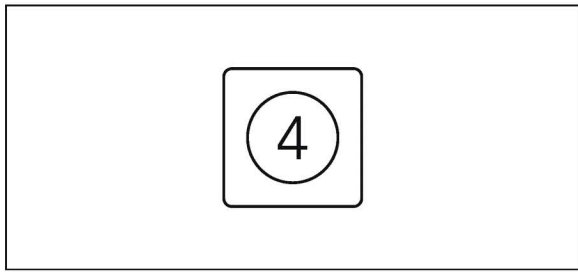

press M4 to eject OP–XY from your computer.

20. synth engines

OP–XY features 8 synth engines. each synth engine has a unique sound, expanding the sonic palette of the device.

change engine

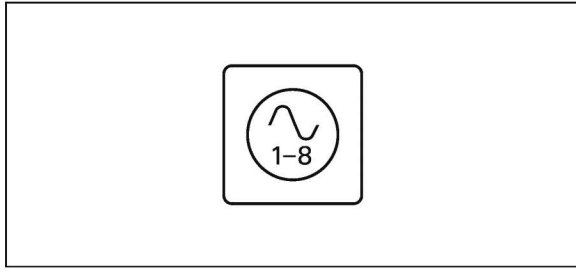

first enter instrument mode to view and edit the instrument tracks.

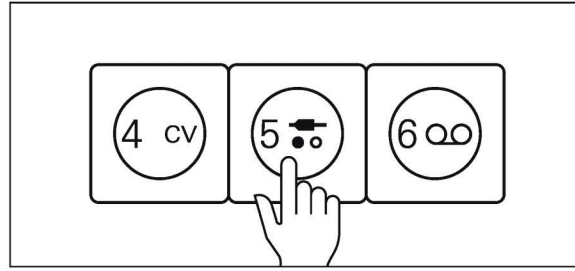

select the instrument track you wish to edit.

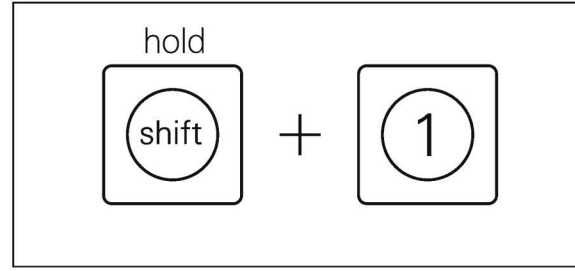

hold shift and press M1 to select the synth engine on that track.

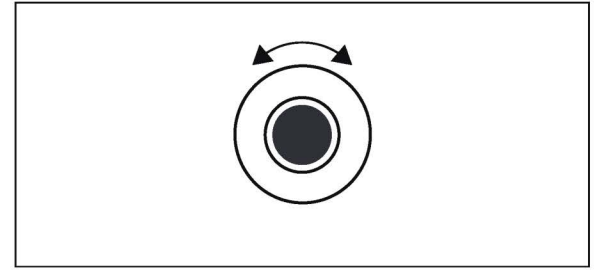

you can then use the dark gray knob to scroll through the list and select an engine. click the encoder or press M1 to confirm your selection.

20.1 axis

axis is an fm synth engine tailored for creating lush string sounds.

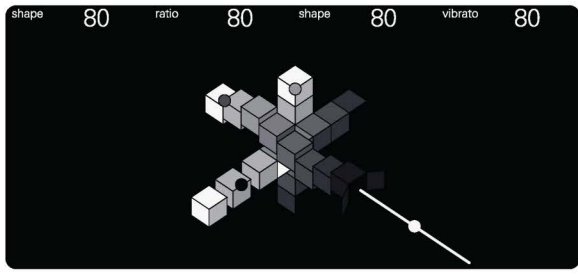

tone

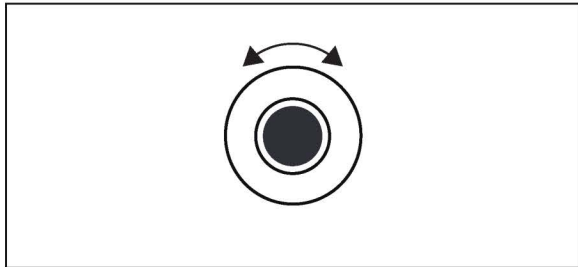

rotate the dark gray knob to adjust the tone of the sound. tone allows you to make the sound brighter or darker.

ratio

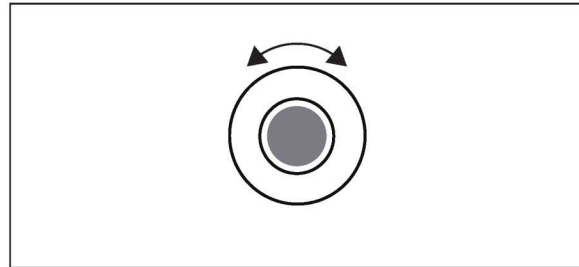

rotate the mid gray knob to adjust the ratio of the sound. this is the pitch of one of the oscillators and goes from a detune (from 0-50) to ascending fifths (from 51-100).

shape

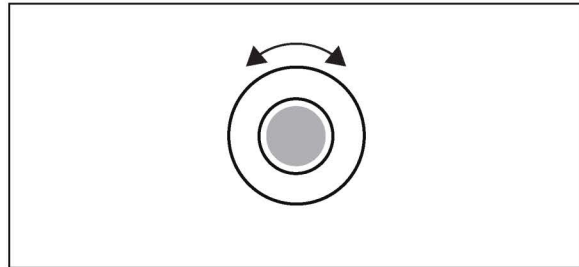

rotate the light gray knob to adjust the wave shape of the oscillators.

tremolo

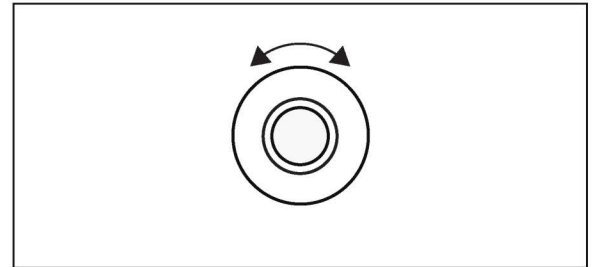

rotate the white knob to adjust the speed and amount of tremolo. tremolo oscillates the volume of the sound.

20.2 dissolve

dissolve is a tonal noise synth engine, perfect for ambient pads and bright, noisy leads.

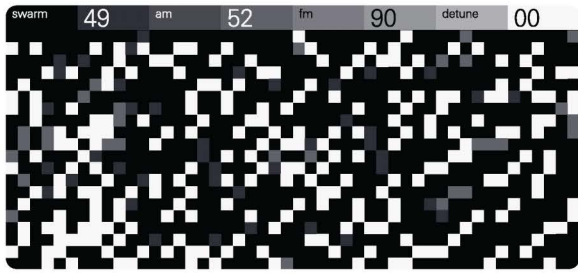

swarm

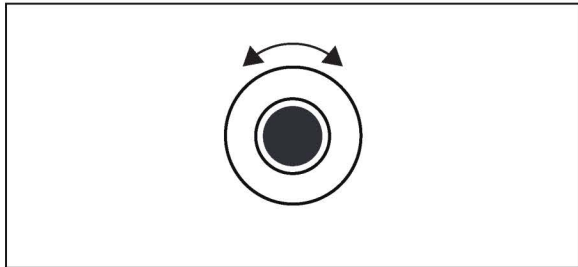

rotate the dark gray knob to adjust swarm. swarm modulates the oscillators with noise.

am

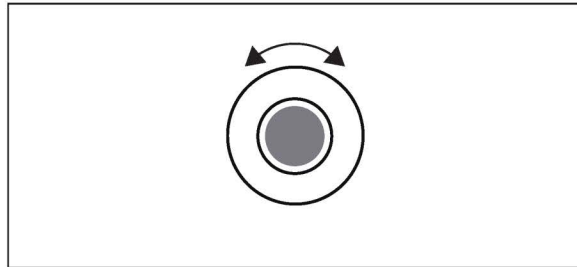

rotate the mid gray knob to adjust am. this modulates the amplitude of the sound, adding grit

fm

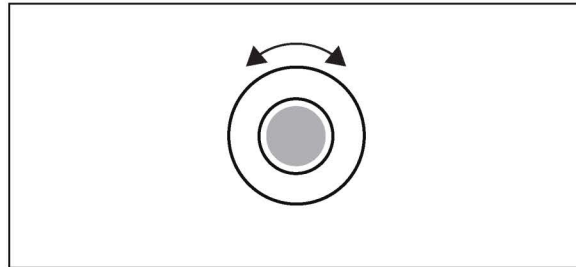

rotate the light gray knob to adjust fm. this modulates the frequency and adds tonality to the sound.

detune

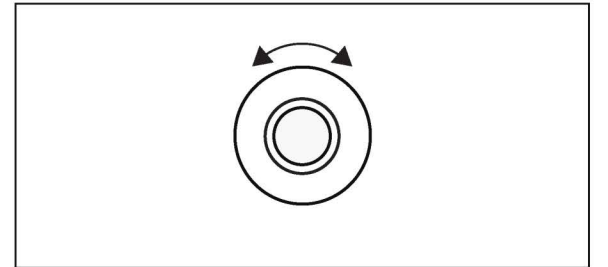

rotate the white knob to adjust the detune of the oscillators. this changes the pitch of each oscillator subtly to create a richer sound.

20.3 epiano

epiano is an electronic piano emulation and can create plucky epiano sounds, powerful leads and thick basses.

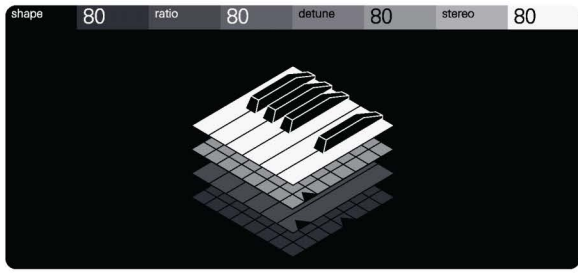

tone

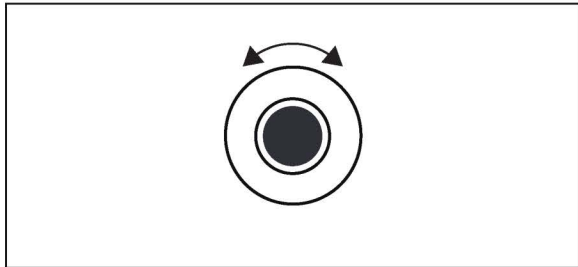

rotate the dark gray knob to adjust the tone of the sound. tone allows you to make the sound brighter or darker.

texture

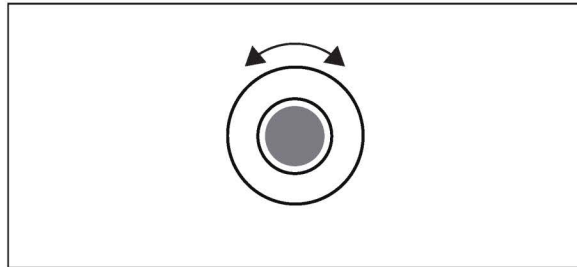

rotate the mid gray knob to adjust texture. texture brings grit to the sound.

punch

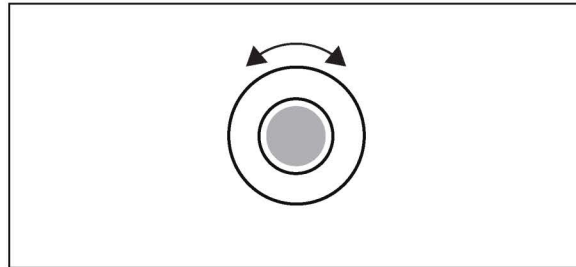

rotate the light gray knob to adjust punch. punch adds even more movement to your sound.

tine

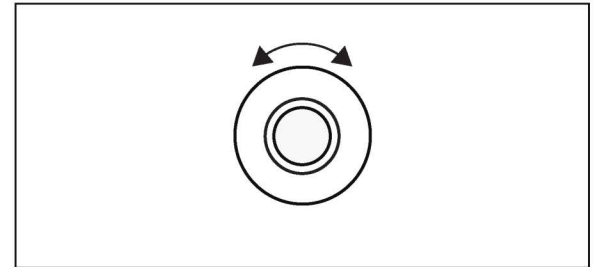

rotate the white knob to adjust tine. tine adds high frequencies to the start of your sound, emulating the sound of the tine within an electronic piano.

20.4 external

external allows you to turn an instrument track into a midi sequencing track for an external midi device.



external midi track

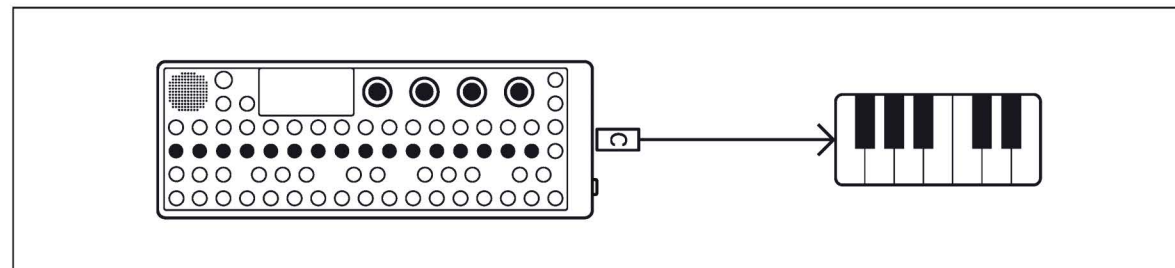
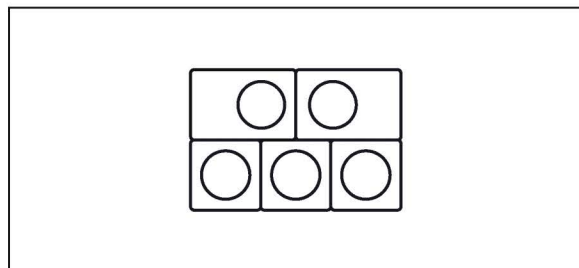

here you can use the musical keyboard to play notes on external midi devices, as well as sequence those notes on the sequencer.

when setting an instrument track to an external midi track you can control which midi channel, bank and program you want to control as well as offering 8 midi CCs that can be edited, sequenced and recorded.

channel, bank and program

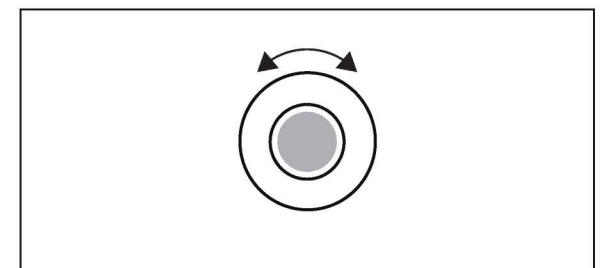
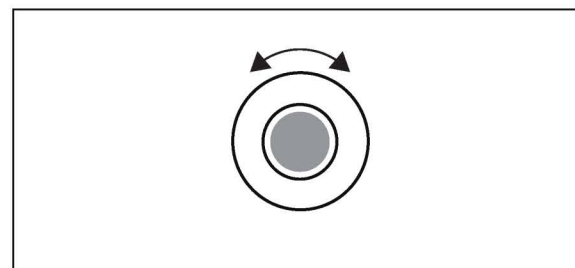
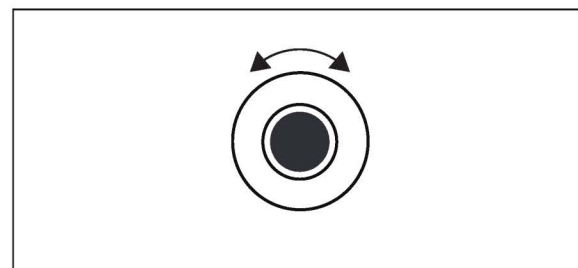
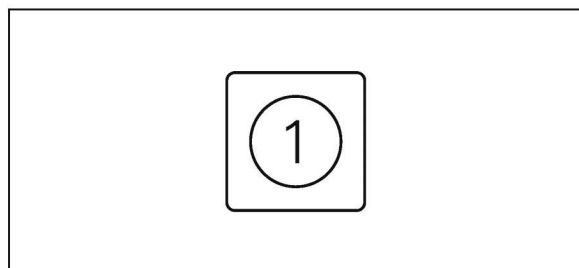

within M1 you will find the controls for channel, bank and program. in a typical midi set up, each device listens to a different channel. some devices may use banks and programs to select a particular sound.

rotate the dark gray encoder to select midi channel.

rotate the mid gray encoder to select the bank.

rotate the light gray encoder to select a program.

midi CCs

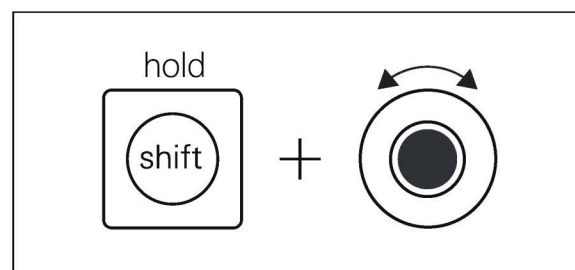
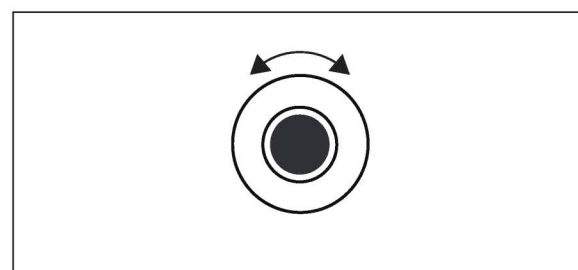
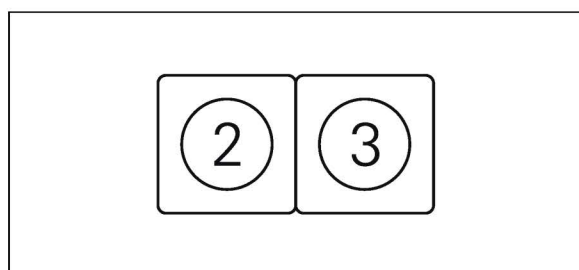

within M2, M3 you will find the midi CCs.

rotate each of the encoders to edit the available CCs.

hold shift and rotate the encoders to turn on or select the CC message.

20.5 hardsync

hardsync is perfect for stabs, jabs and solid basses.

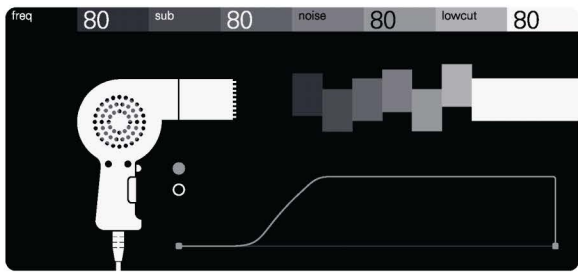

freq

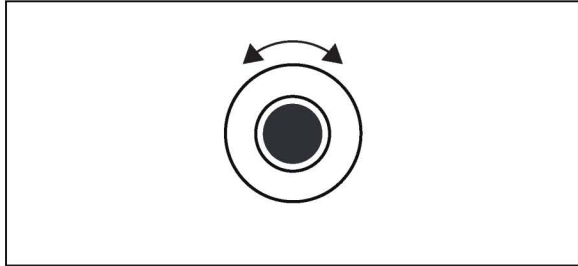

rotate the dark gray knob to adjust the frequency. this adjusts the tone, shifting the harmonics.

sub

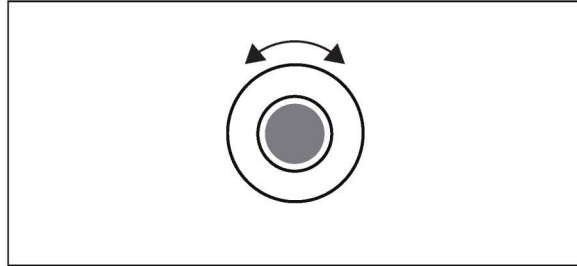

rotate the mid gray knob to add a sub bass to the sound. perfect for thickening pads or doubling down your bass.

noise

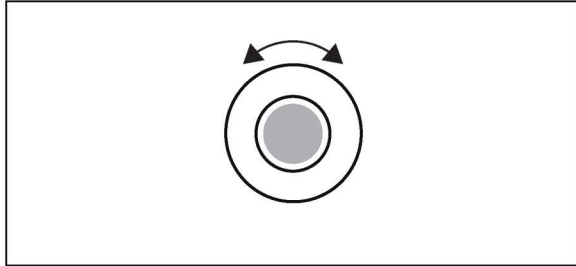

rotate the light gray knob to add noise, this is great for brightening the sound.

lowcut

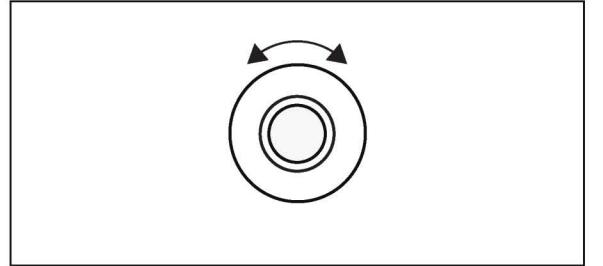

rotate the white knob to filter out low frequencies.

20.6 organ

channel your inner bach with the organ. organ can create a wide range of amazing organ sounds from transistor to church with the twist of a knob.

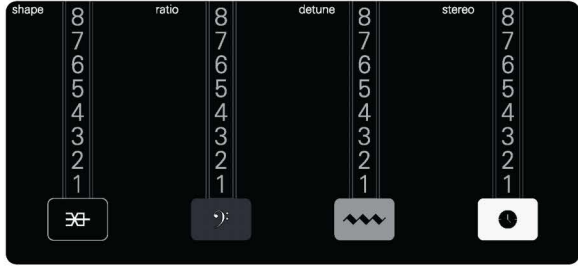

type

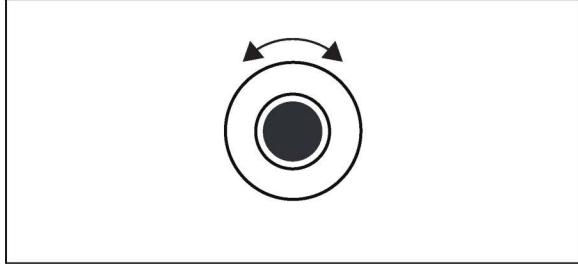

rotate the dark gray knob to switch between different organ types.

bass

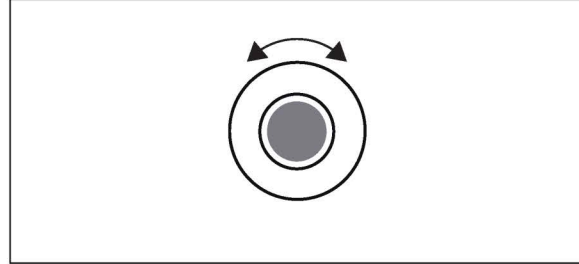

rotate the mid gray knob to add or remove bass, thickening your sound.

tremolo amount

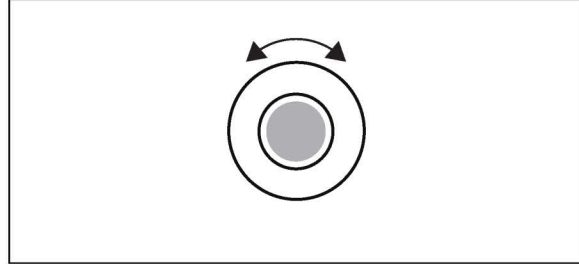

rotate the light gray knob to adjust the amount of tremolo. the tremolo modulates the volume of the organ.

tremolo speed

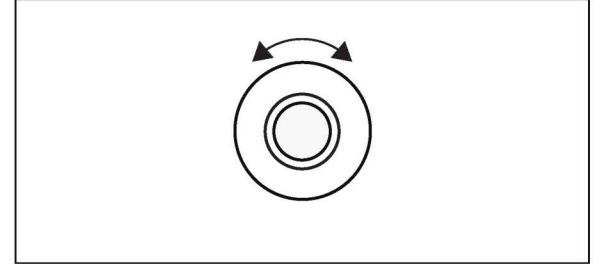

rotate the white knob to adjust the speed of the tremolo. turn it down to create slow swells or turn it up to create dizzying pads.

20.7 prism

bend light with the prism. perfect for bread and butter basses, synth leads and everything in between.

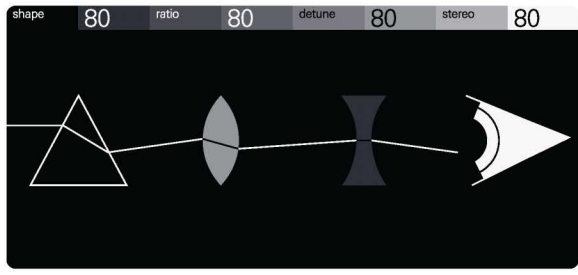

shape

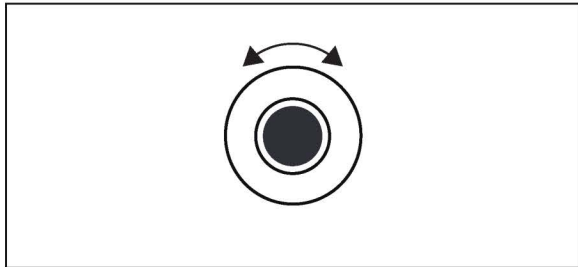

rotate the dark gray knob to adjust the shape of the oscillators.

ratio

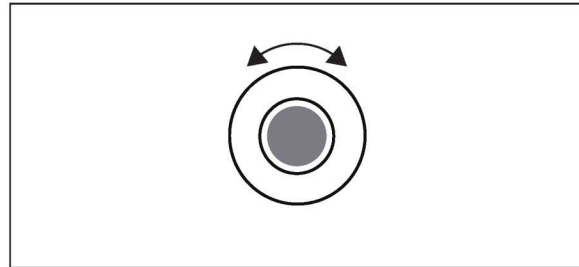

rotate the mid gray knob to adjust the ratio between the oscillators.

detune

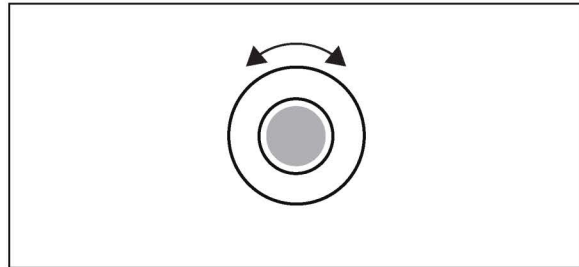

rotate the light gray knob to adjust the amount of detune, this is a subtle shift in pitch between oscillators.

stereo

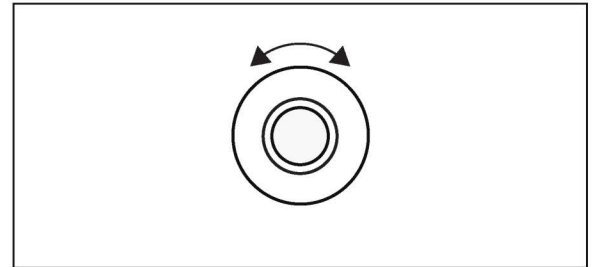

rotate the white knob to adjust the stereo spread of the oscillators.

20.8 simple

simple allows you to quickly craft basic patches, great for leads and plucks.

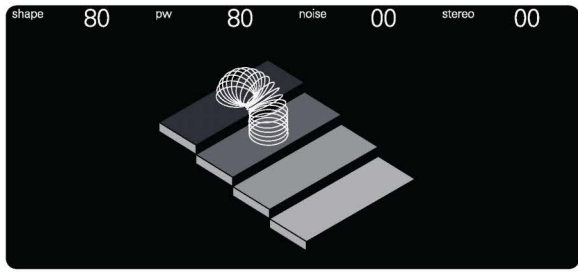

shape

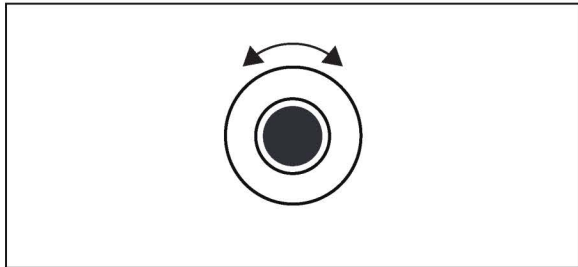

rotate the dark gray knob to adjust the shape of the oscillator.

pw

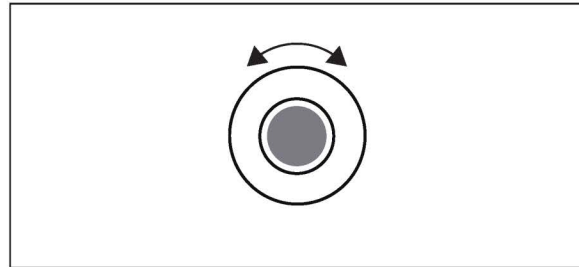

rotate the mid gray knob to adjust the pulse width of the oscillator.

noise

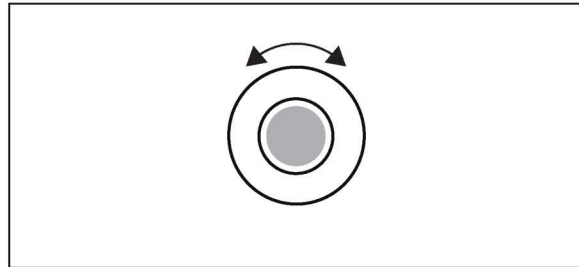

rotate the light gray knob to add or remove noise. this can help create buzzy leads or soft pads.

stereo

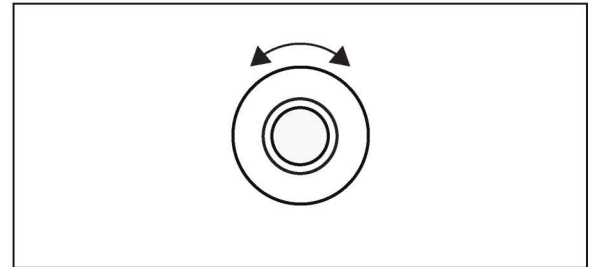

rotate the white knob to adjust the stereo spread of the oscillators.

20.9 wavetable

wavetables are waveforms arranged one after the other in a look up table, this allows you to smoothly transition between a range of predefined oscillator shapes.

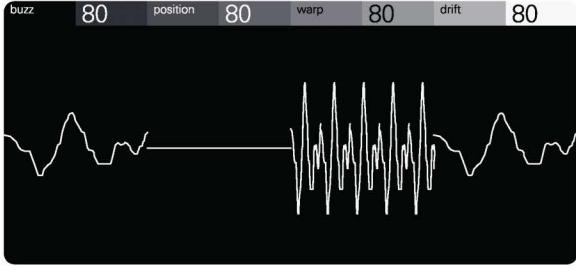

table

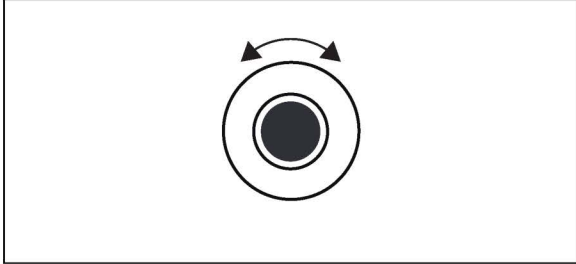

rotate the dark gray knob to select the wavetable. wavetable comes with 9 different wavetables.

position

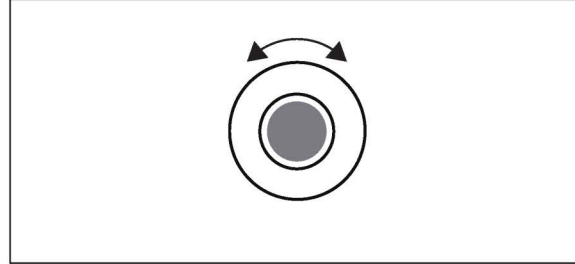

rotate the mid gray knob to adjust the position in the wavetable.

warp

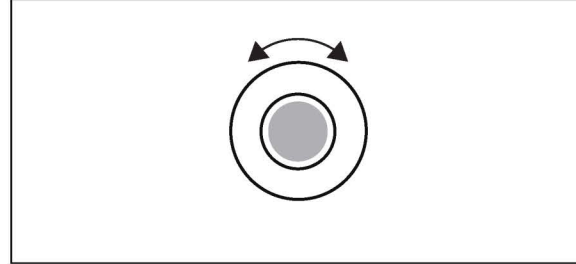

rotate the light gray knob to warp the shape of the waveform.

drift

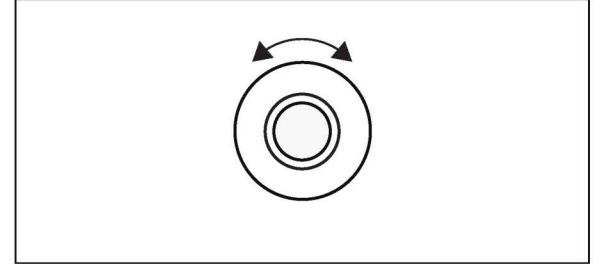

rotate the white knob to adjust the drift of the wavetable. this will make the warping drift from the note frequency to create inharmonic textures.

21. fx

OP–XY features 6 built-in send fx that can be assigned to two fx tracks.

change fx

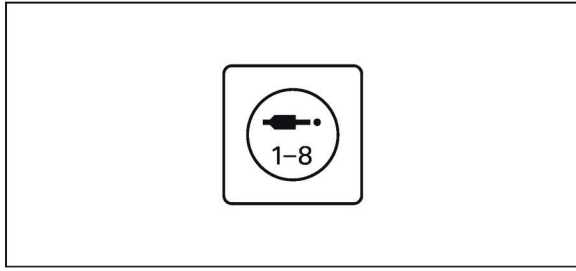

first enter auxiliary mode to view and edit the instrument tracks.

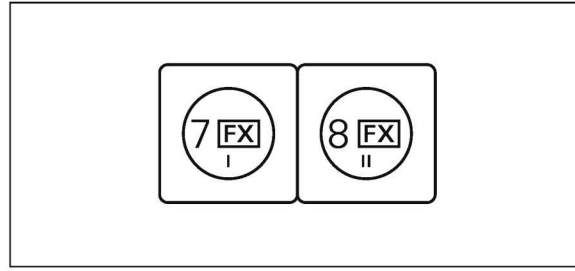

select the fx i or fx ii track.

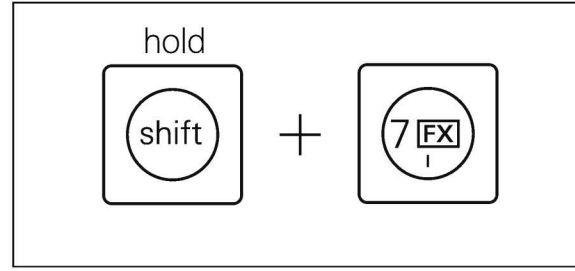

hold shift and fx i or fx ii to select the fx on that track.

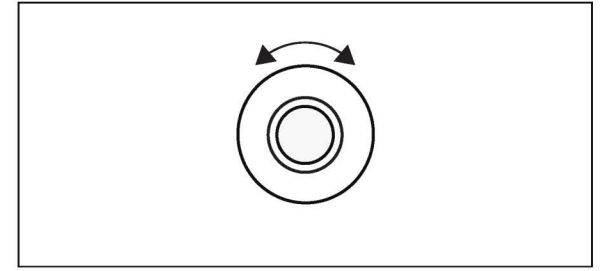

you can then use the white knob to scroll through the list and select an fx. click the encoder or press M1 to confirm your selection.

21.1 chorus

chorus duplicates the sound running through it and shifts the pitch and timing very slightly, or very dramatically. this can be used to create a wider sound.

rate

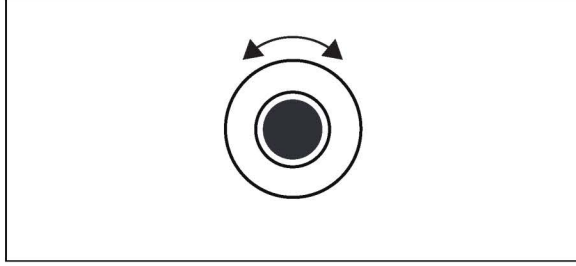

rotate the dark gray knob to adjust the rate of the chorus, this is how fast pitch of the sound running through it is modulated.

depth

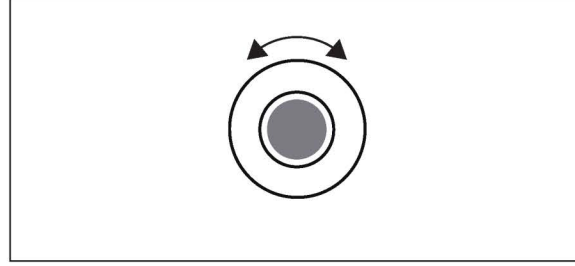

rotate the mid gray knob to adjust the depth of the effect and thus how much the pitch of the incoming signal is modulated

feedback

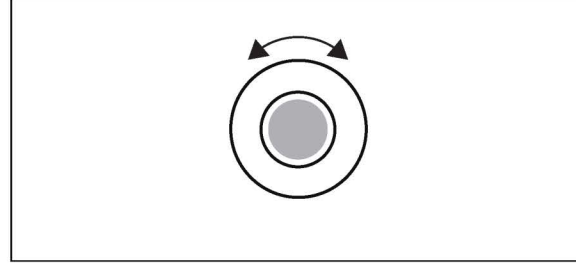

rotate the light gray knob to adjust how much the chorus feeds back into itself, this can be used to create a pitch modulated delay at higher feedback amounts.

stereo

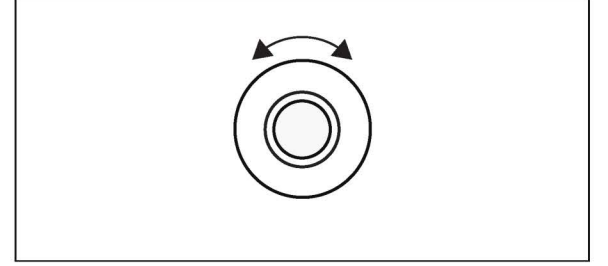

rotate the white knob to adjust the stereo width of the chorus, spreading the sound.

21.2 delay

delay repeats the incoming signal creating an echo.

size

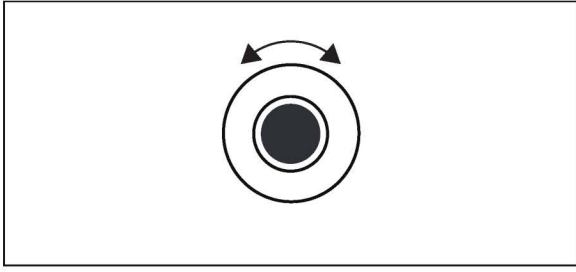

rotate the dark gray knob to adjust the spacing between repeats. there are 8 options ranging from micro to insane.

fine

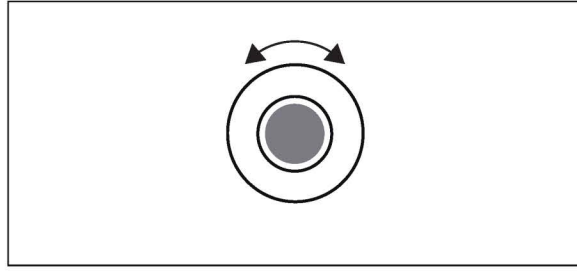

rotate the mid gray knob to fine tune the distance between repeats.

amount

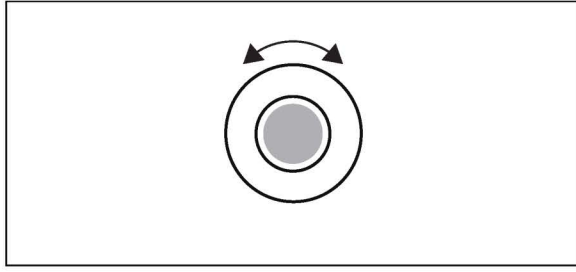

rotate the light gray knob to adjust how much the delay feeds back into itself, extending the delay and thus the number of repeats.

dry

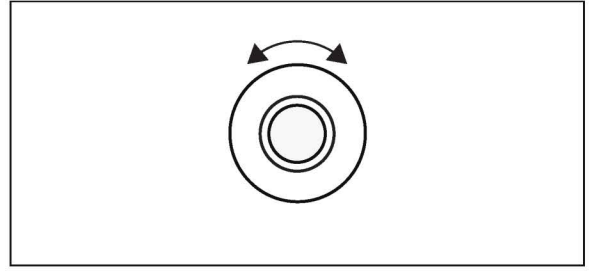

rotate the white knob to adjust the amount of the dry signal with respect to the delay. setting dry to 0 will result in only the repeats with none of the initial sound.

21.3 distortion

distortion breaks down whatever sound comes through it.
use it to add fuzz or completely destroy a sound.

drive

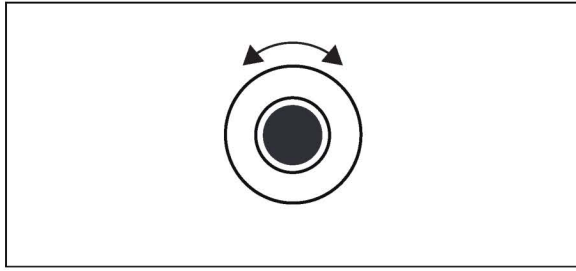

rotate the dark gray knob to adjust the drive, this is the volume of the audio going into the distortion.

clip

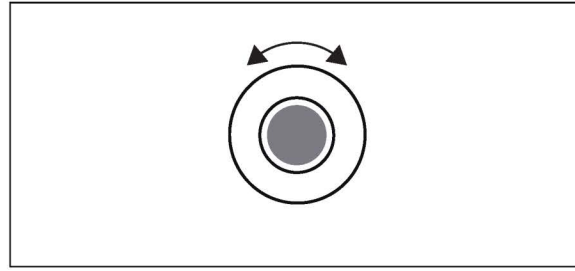

rotate the mid gray knob to adjust the clipping amount.

low cut

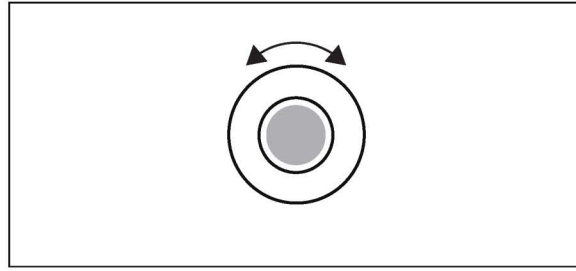

rotate the light gray knob to adjust amount of bass frequencies going into the distortion.

high cut

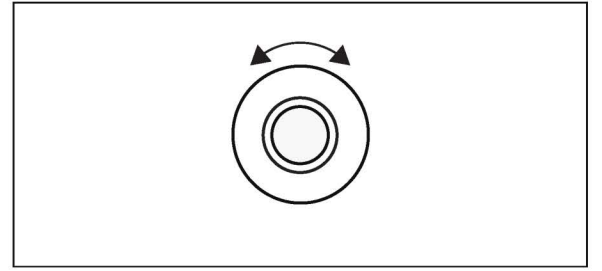

rotate the white knob to adjust the amount of high frequencies going into the distortion.

21.4 lofi

use lofi to bitcrush your sounds. it's perfect for lofi music, of course, but also just to add grit to a sound.

rate

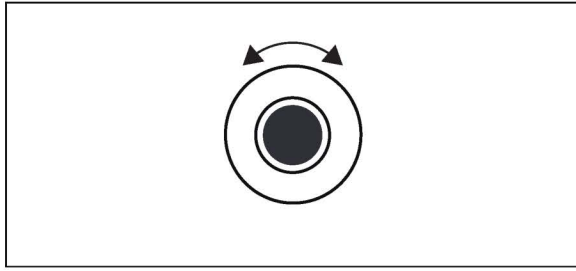

rotate the dark gray knob to adjust the sample rate of the lofi fx.

bits

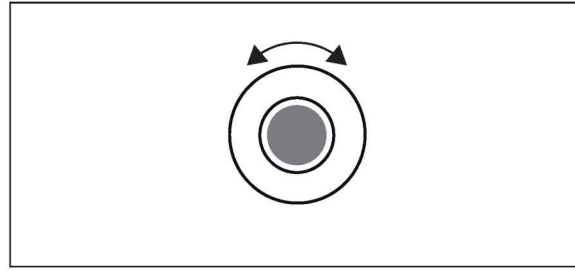

rotate the mid gray knob to adjust the bitrate of the lofi fx.

quality

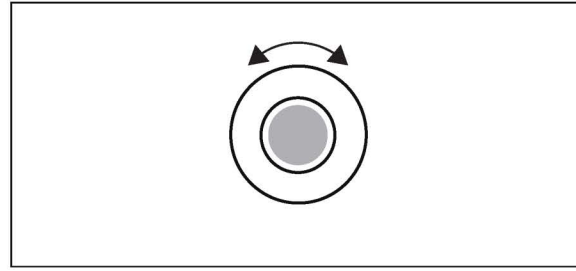

rotate the light gray knob to adjust the quality of the lofi.

drift

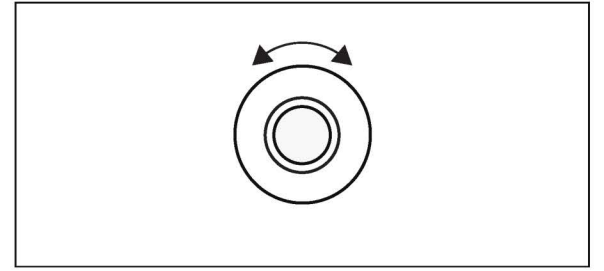

rotate the white knob to adjust the stereo spread of the audio.

21.5 phaser

phasers comb through your sound with filters, then mix them back with the original audio, cancelling out whatever is out of phase. OP–XY features a 12-pole phaser, that's 12 notches on the comb.

frequency

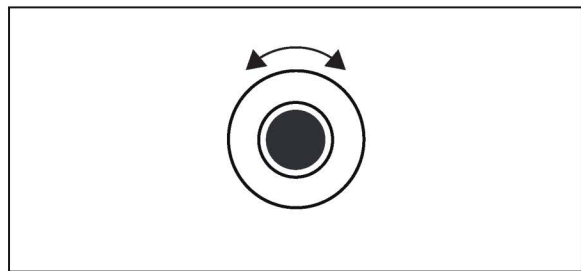

rotate the dark gray knob to adjust the center frequency of the phaser. this is the frequency around which the phaser moves.

depth

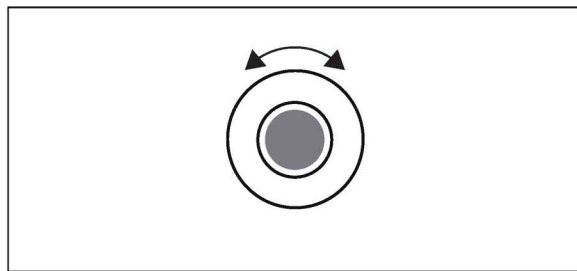

rotate the mid gray knob to adjust the depth of the phaser, the higher the depth the more it moves.

rate

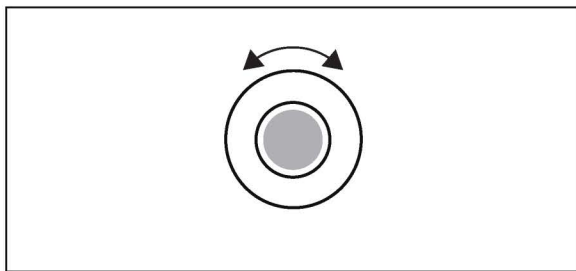

rotate the light gray knob to adjust the rate of the phaser, turn it up to go faster, or down to slow it right down.

feedback

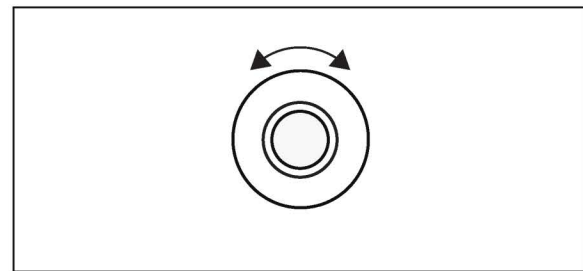

rotate the white knob to adjust the feedback of the phaser, this changes how much of the signal out of the phaser feeds back into it. turn it up and hear it sing.

21.6 reverb

reverb can take your sound from a closet to a cathedral. you can use it creatively to emphasise a sound, or strategically to smooth out your mix.

size

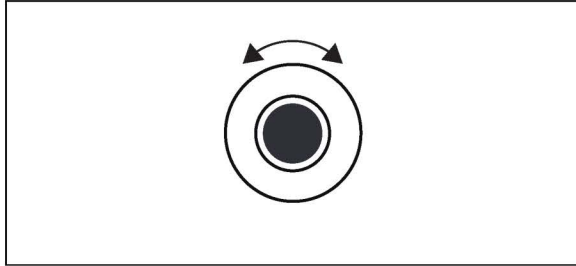

rotate the dark gray knob to adjust the size of the reverb from a room to a cathedral.

modulation

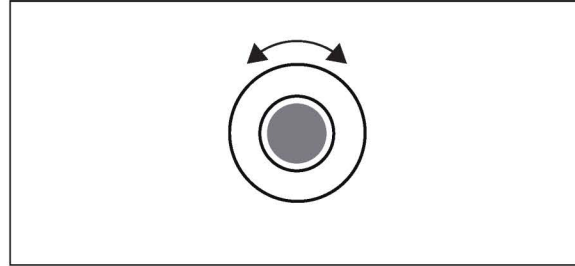

rotate the mid gray knob to adjust the modulation of the reverb, this will add a swelling chorus effect.

tone

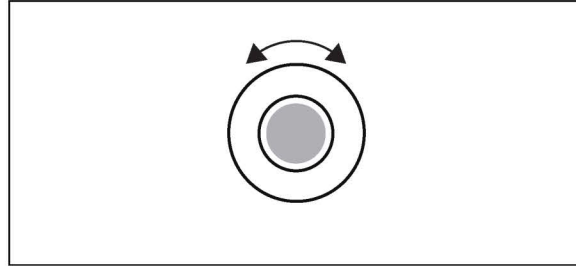

rotate the light gray knob to adjust the tone of the reverb, filtering out high or low frequencies.

dry

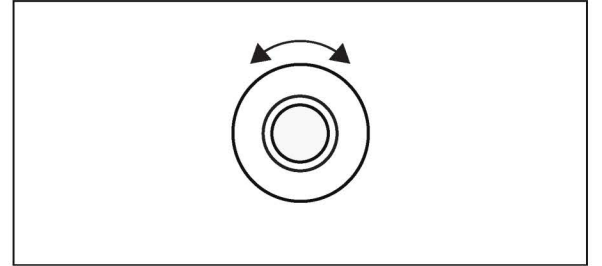

rotate the white knob to adjust the mix of dry signal through the reverb. this is a seamless control between insert and send.

22. how to

in this chapter we will cover some common questions you may face while using your OP–XY.

22.1 how to enable velocity

velocity allows you to play notes on the OP–XY's musical keyboard with additional expression.

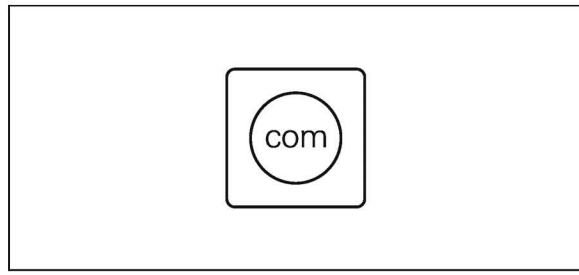

to enable velocity, first press com to enter the com page.

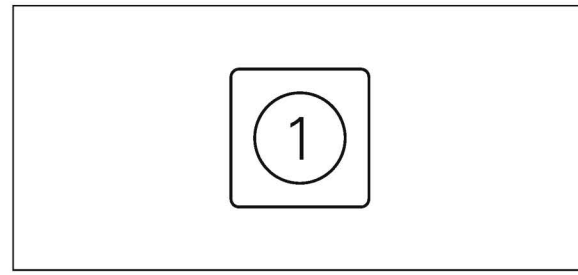

press M1 to enter system settings.

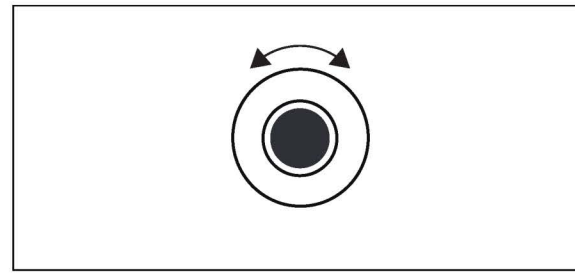

use the dark gray encoder to navigate to keyboard settings.

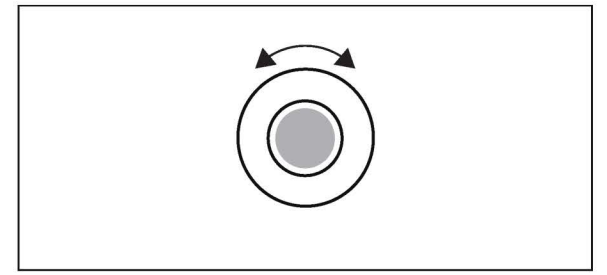

ensure that the velocity setting is selected, then rotate the light gray encoder to select the velocity setting. there are three settings:
off
soft (for gentler playing)
hard (for more vigorous playing)

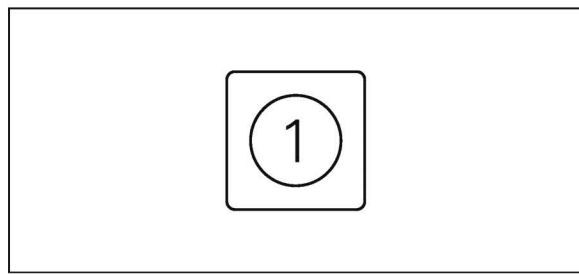

press M1 to go back to the com page.

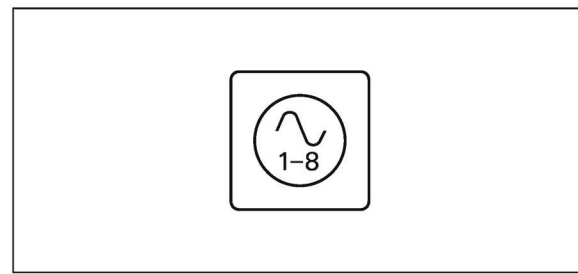

finally, press instrument to return to the instrument mode and continue composing.

22.2 how to control a synth with midi

midi is a powerful and simple protocol that connects music devices. let's use it to control a synthesiser.

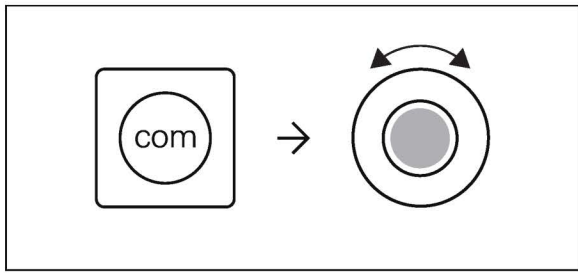

start by setting the multi out port on OP-XY to midi. press com to view the com screen, then rotate the light gray knob until midi is shown on the screen.

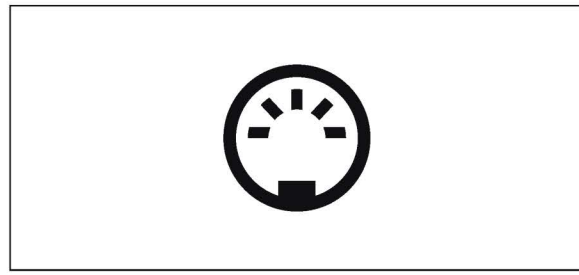

connect a midi cable to your synthesiser. some synthesisers use din midi, these will require a type a trs to midi cable, others may have a usb connection, these can be plugged directly into OP-XY with a usb-c adapter and will not require you to set the multi-out port to midi.

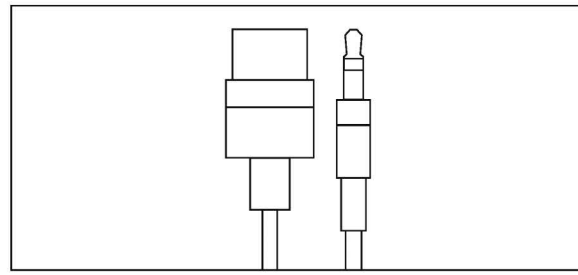

if using a type a trs to midi din cable, connect the din end to the synthesiser and the trs end to the multi out port on the OP-XY. if using a usb cable, ensure to use an adapter to usb-c from whatever usb connector is used by the other device.

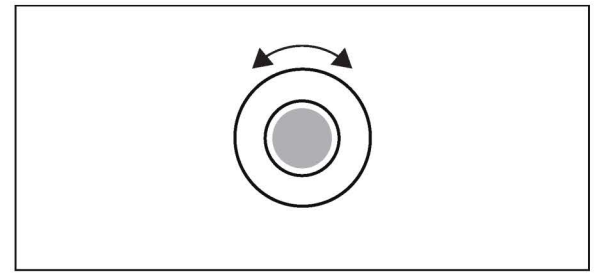

for usb midi devices, you can view the connected device in the devices screen, allowing you to view and edit what data is sent and received.

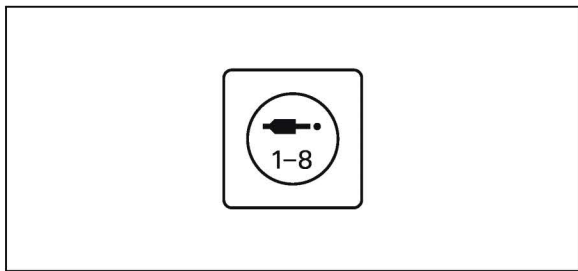

press auxiliary to open the auxiliary mode.

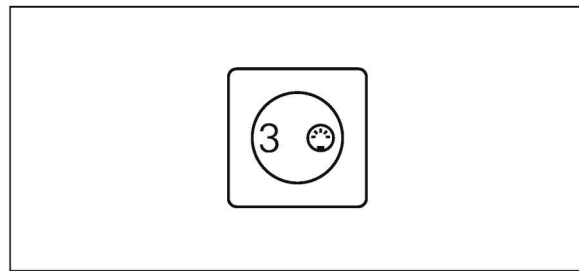

press track 3 to view the external midi track. you can alternatively use an instrument track with the engine set to 'external' (for example if you want to sequence multiple midi devices).

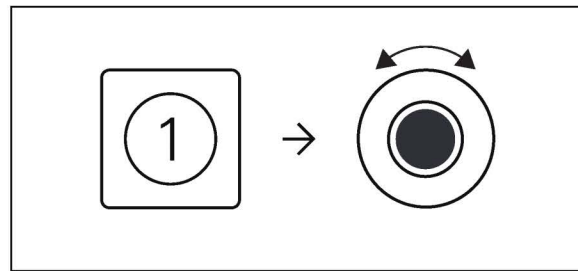

ensuring that you are in the M1 screen, set the midi channel with the dark gray knob. if you are unsure which midi channel the connected synthesiser or midi device is operating under, you can check it in the documentation for that device.

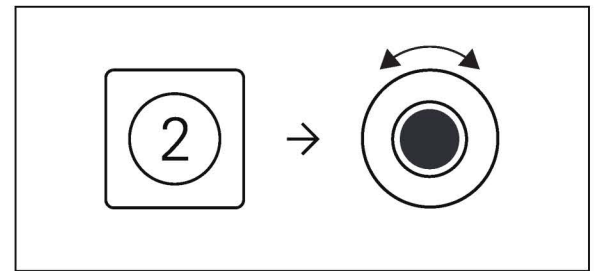

pressing M2 or M3 will allow you to view and edit eight different midi CCs. to set the CC hold shift and rotate one of the encoders. to set the value on that CC rotate the desired knob.

bonus tip!

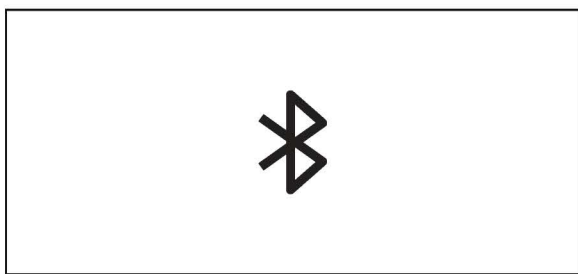

some devices are capable of using bluetooth for midi.

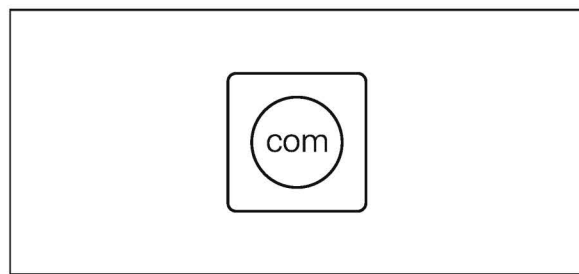

to connect the OP-XY to a bluetooth midi capable device firstly press com.

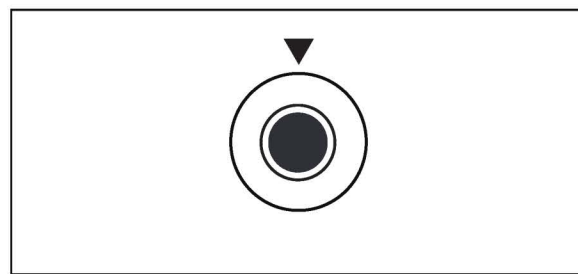

once in the com screen press down the dark grey encoder to advertise the OP-XY over bluetooth midi.

on the other device, follow the procedure for bluetooth midi connection.

22.3 how to control an analog synth with cv and gate

cv stands for 'control voltage' and is the standard used by most analog synthesisers as well as eurorack devices to send and receive note data. gate, on the other hand, is used to trigger envelopes and is sent only when a note is pressed down.

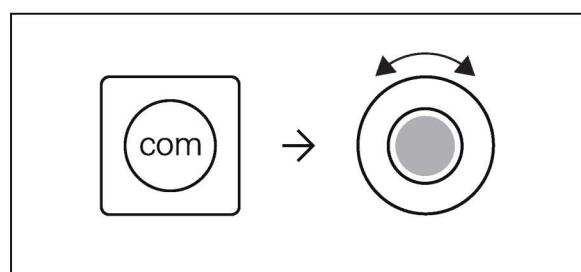

start by setting the multi out port on OP-XY to cv/gate. press com to view the com screen, then rotate the light gray knob until cv is shown on the screen.

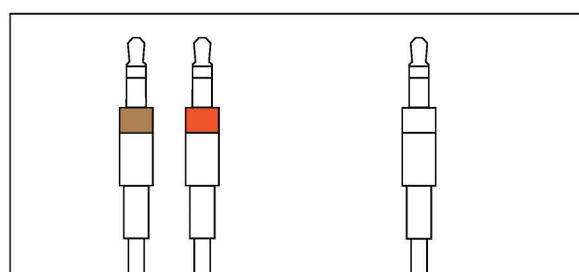

OP-XY outputs cv on the tip and gate on the ring, so to split the note and trigger you will need a splitter cable. ensure to use one that separates the left (tip) and right (ring) signals rather than one that maintains the stereo. some analog synthesisers may require a 6.35mm jack and others such as eurorack 3.5mm so ensure to use the right dimensions on both ends.

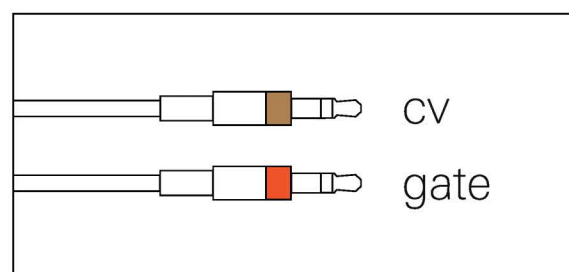

connect the left (tip) channel to the cv input on your synthesiser and the right (ring) channel to the gate input on your synthesiser. some modular synths will have the cv input on the oscillator and the gate input on the envelope.

note: ensure you have everything correctly set up and connected before proceeding to the next step.

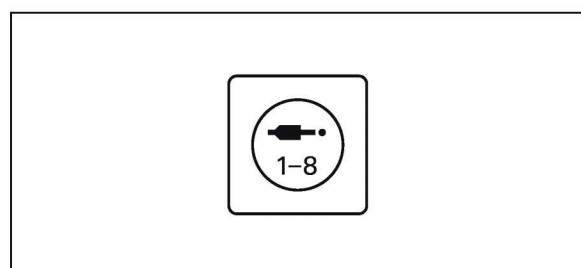

press auxiliary to open the auxiliary mode.

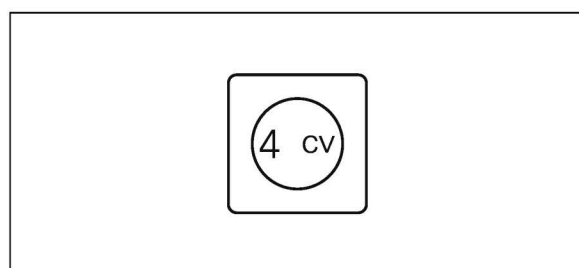

press track 4 to view the cv track.

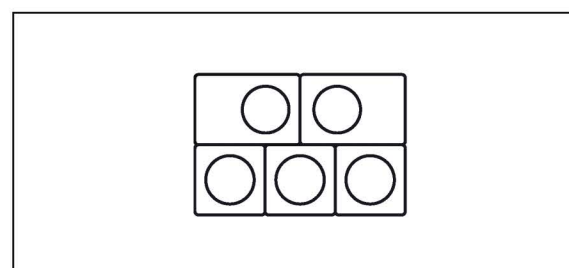

you can now play the musical keyboard and the notes played will be sent to your synth as cv and the duration it is held as gate.

22.4 how to sync a vintage drum machine

sync keeps everything in time, think of it as the heartbeat of your music setup. vintage drum machines often have sync ports but use a different standard to most modern devices.

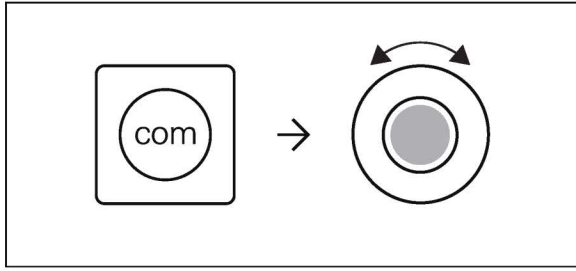

start by setting the multi out port on OP-XY to sync24. press com to view the com screen, then rotate the light gray knob until sync24 is shown on the screen.

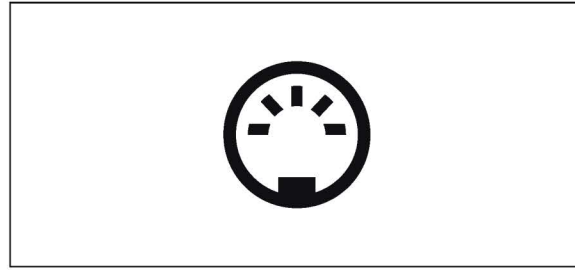

OP-XY will now output sync from the multi-out port, however most vintage drum machines require a din sync cable to receive sync so you will need a 3.5mm to din sync cable.

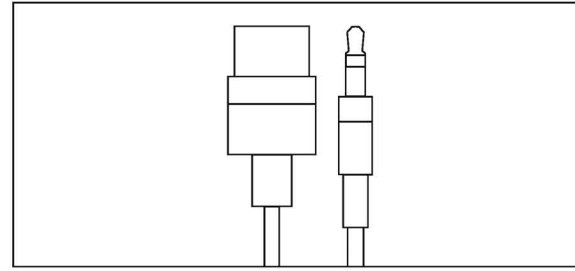

connect the 3.5mm end of your cable to the multi-out port on OP-XY and the din end to the sync in port on your vintage drum machine.

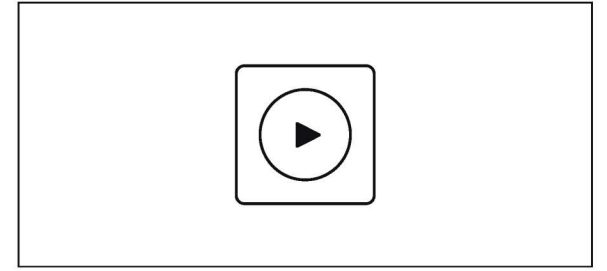

press play on your OP-XY and clock, start, stop and reset will all be transmitted over the cable.

22.5 how to sync a pocket operator

sync keeps everything in time, think of it as the heartbeat of your music setup. pocket operators use a slower clock pulse than some other devices.

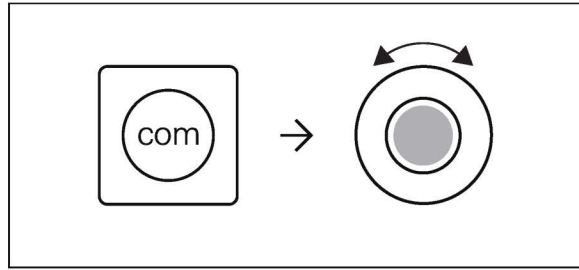

start by setting the multi out port on OP-XY to sync8. press com to view the com screen, then rotate the light gray knob until sync8 is shown on the screen.

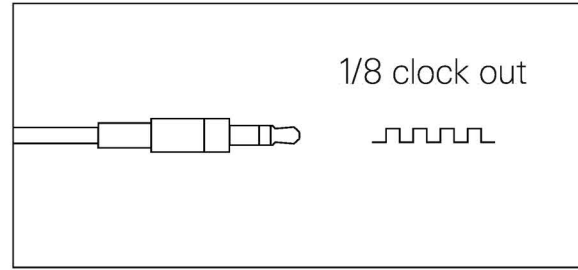

OP-XY will now output an 8th note clock from the multi-out port.

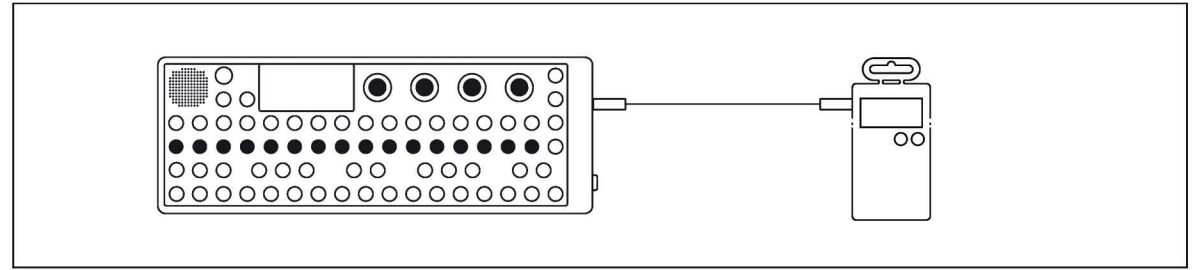

connect a 3.5mm cable from OP-XY's multi-out port to the input port of your pocket operator.

set the pocket operator to sync mode 2. to do so, press the function button under the rightmost knob and the bpm button until the screen shows SY2. this will listen for a sync pulse on the input jack and output stereo audio from the output jack.

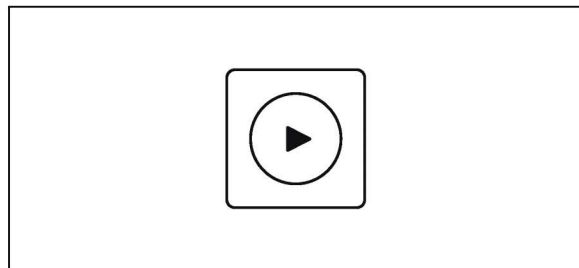

press play on OP-XY and the clock will begin transmitting from OP-XY to the pocket operator, keeping them both in sync.

22.6 how to send audio to and from an external effect

sometimes you want to expand your sound palette and experiment with external effects units. OP–XY is able to send and receive audio so let's look at how you can do it.

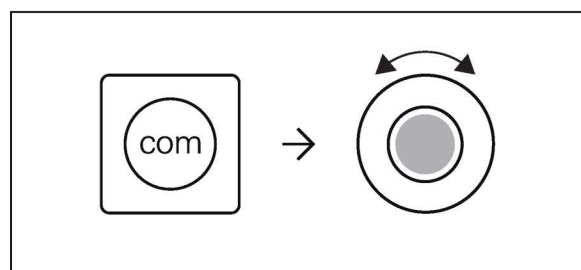

start by setting the multi out port on OP–XY to audio. press com to view the com screen, then rotate the light gray knob until audio is shown on the screen.

OP–XY will now output audio from the multi-out port.

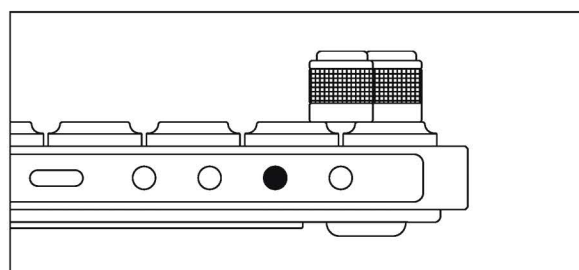

OP–XY will now output audio from the multi-out port.

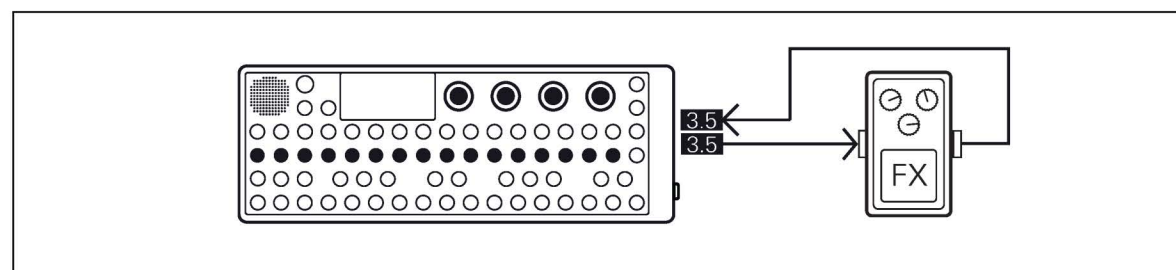

some fx units or pedals will use a 6.35mm input so make sure to use a cable that goes from 3.5mm to whatever your fx unit requires. connect the 3.5mm end into the multi-out port on OP–XY and the other end into the input on your fx unit or pedal.

you can then use a similar cable to connect from the output on the fx unit to the audio input on OP–XY.

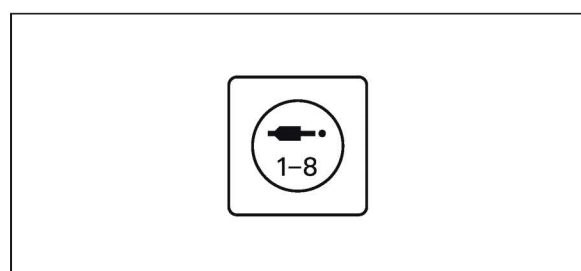

press auxiliary to open the auxiliary mode.

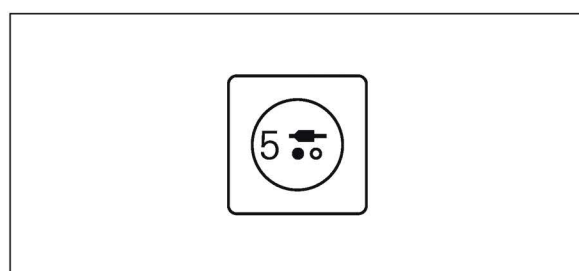

press track 5 to view the external audio track.

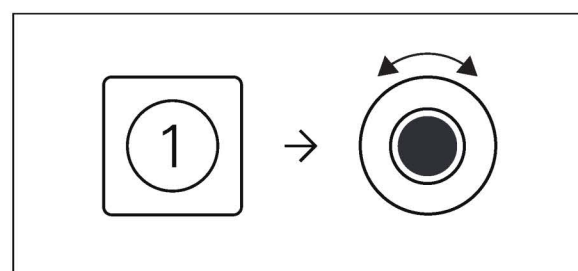

ensuring that you are in the M1 screen, rotate the dark grey knob until the audio jack shows, this represents the audio input port on OP–XY.

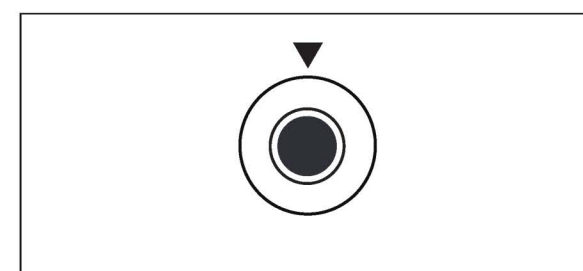

click the dark gray encoder to enable the audio input.

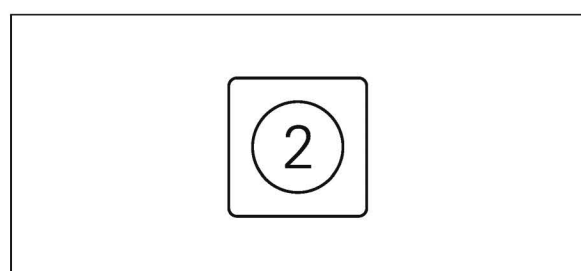

now press M2 to route audio to the OP–XY's auxiliary audio output (on the multi-out port).

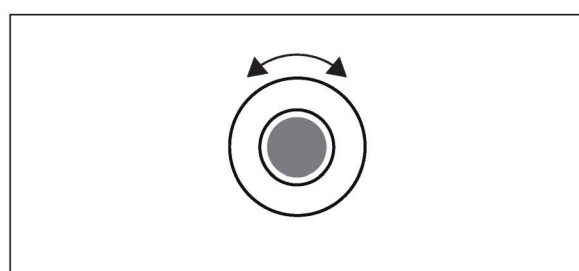

rotate the encoders corresponding to the track you wish to send out of the aux output. recall that clicking the encoders switches between tracks 1-4 and 5-8.

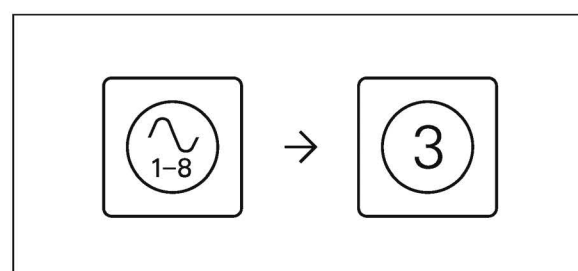

you can alternatively send audio from the track level by going into instrument mode, selecting a track and then navigating to the sends page by viewing the filter (M3) and holding shift. the aux audio out can be configured with the dark gray encoder.

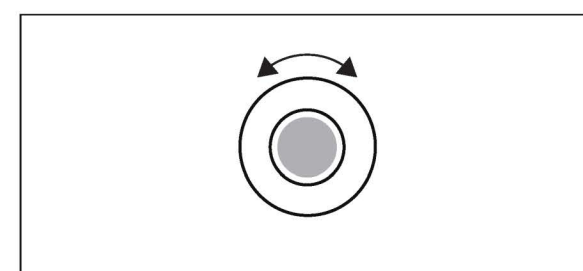

audio sent through the external audio track should now run through your fx unit or pedal and back into the OP–XY. in the external audio track use drive, level and mix under M1 to balance the return audio as you see fit.

22.7 how to control OP–XY with a midi keyboard

occasionally you may find that you want a greater range than the musical keyboard on the OP–XY can offer. use a midi keyboard to expand that range or even a midi controller to expand the controls.

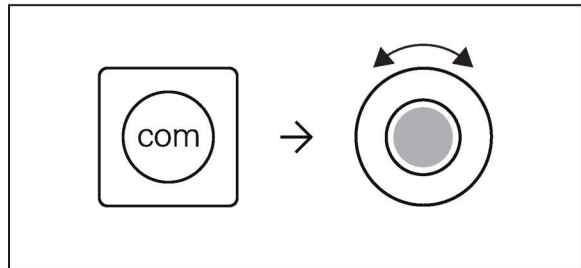

before you get started, you will need either a cable that goes from usb-c to whatever your midi keyboard/controller expects, or a usb-a to usb-c adaptor to convert an existing cable to one that will work with OP–XY.

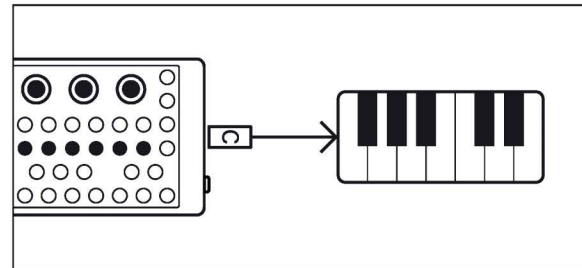

connect the usb-c end of the cable into the usb-c port on OP–XY and the other end into your midi keyboard/controller.

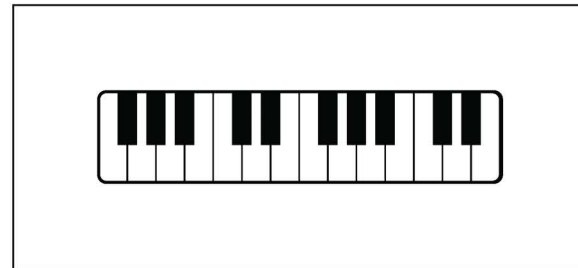

the keyboard/controller should almost immediately connect. some devices may require extra power, if so you can use a powered usb hub.

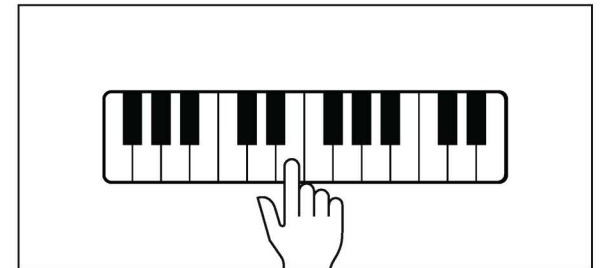

you can then use the keyboard/controller to play and control your OP–XY.

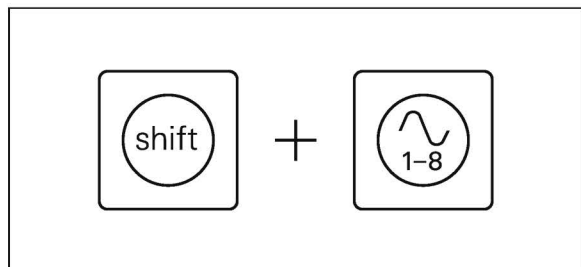

if you wish to assign the modwheel, aftertouch, pitchbend and velocity to modulate the synth parameters you can do so by opening the preset settings by pressing shift and instrument.

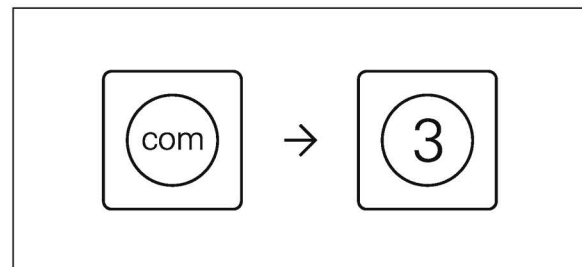

to adjust what midi data is sent and received, press com, followed by M3 to enter the devices view. here you can enable or disable clock, notes, other (CCs, and other controls), timestamp and velocity.

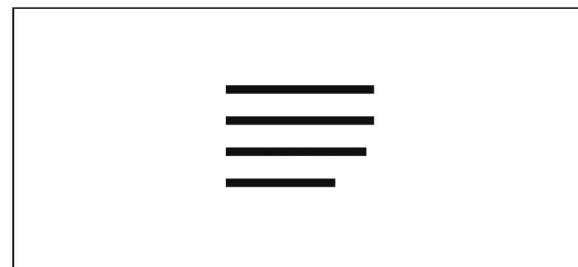

if you want a full list of CCs to map your controller to, you can find them in the [midi CC reference table](#).

22.8 how to use an audio interface with OP–XY

audio interfaces offer a greater level of flexibility with audio in and out. they are great for production scenarios but also for performance.

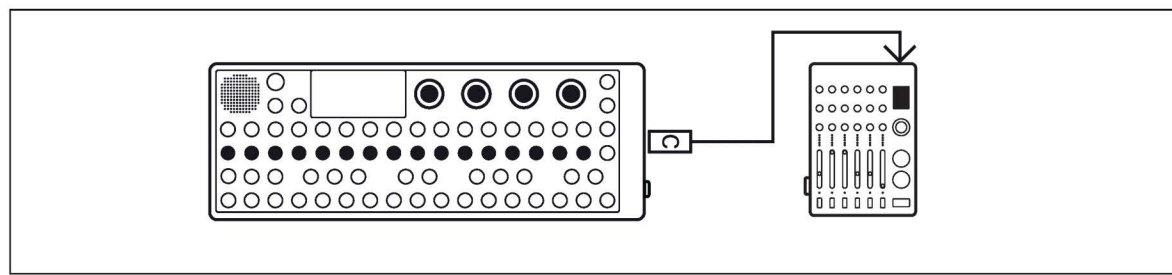
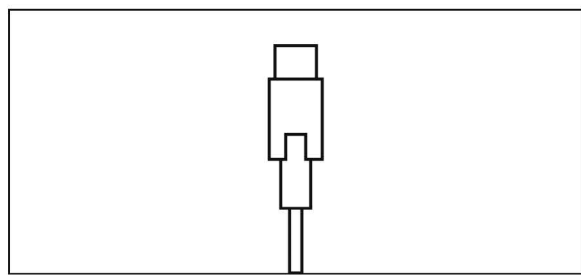

before you get started, you will need either a cable that goes from usb-c to whatever your audio interface expects, or a usb-a to usb-c adaptor to convert an existing cable to one that will work with OP–XY.

connect the usb-c end of the cable into the usb-c port on OP–XY and the other end into your audio interface.

the audio interface should almost immediately connect. some devices may require extra power, if so you can use a powered usb hub.

note: OP–XY is compatible with class 1 and class 2 compliant audio interfaces however non class compliant interfaces may not work.

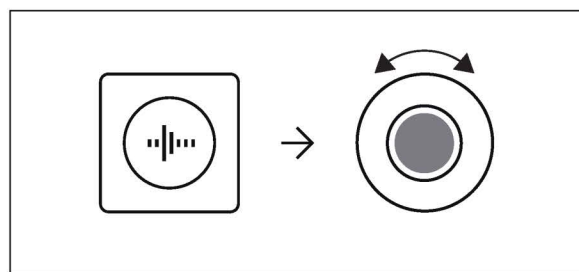
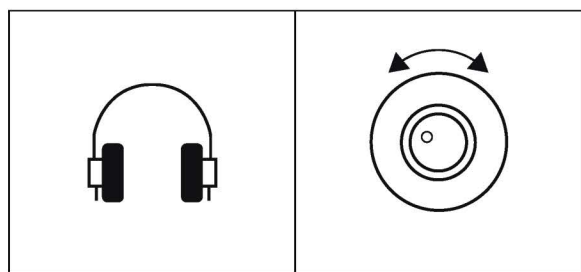

OP–XY should now output its main audio out through the audio interface. turn the volume down with the volume knob if you wish to not hear the speaker as well, or connect a pair of headphones and monitor the output.

OP–XY supports multi-channel interfaces and will by default select channels 1 and 2. if you wish to change which channels are input, you will need to press the sample button, then select usb as the input with the dark gray knob and then select the channel with the mid gray knob.

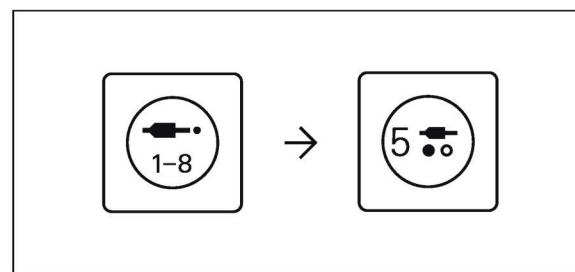

if you wish to have audio running from your audio interface into the external audio channel on OP–XY, first open the external audio track in the auxiliary mode.

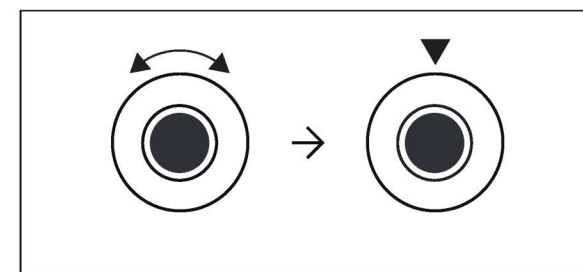

you can then select the usb as source in the input by rotating the dark gray knob then clicking it to activate the input. you can find out more about external audio in the [external audio track chapter](#).

22.9 how to use the pitchbend as a modulation source

sometimes you want a little more expression while playing or performing. the pitchbend on OP-XY is a great way to add expression, lets use it.

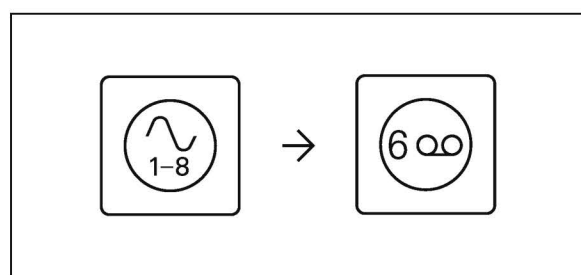

while in instrument mode, select a track.

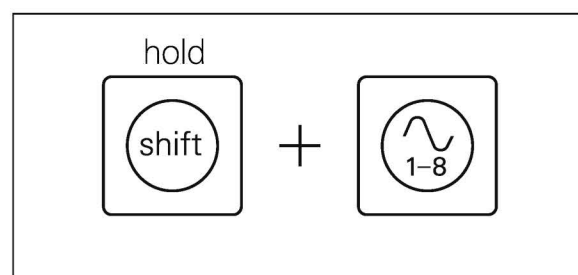

hold shift then press instrument to enter the preset settings.

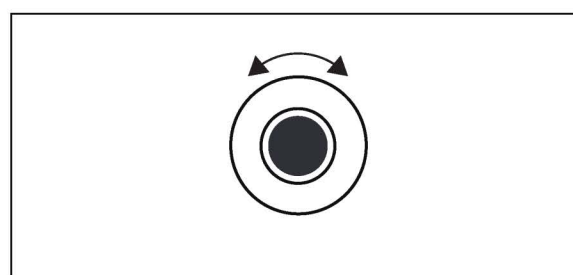

rotate the dark gray knob to select 'mod'.

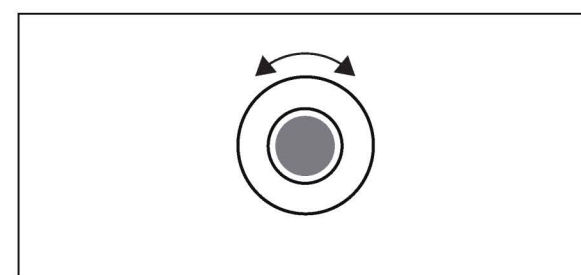

now, rotate the mid gray knob to select 'pitchbend target'.

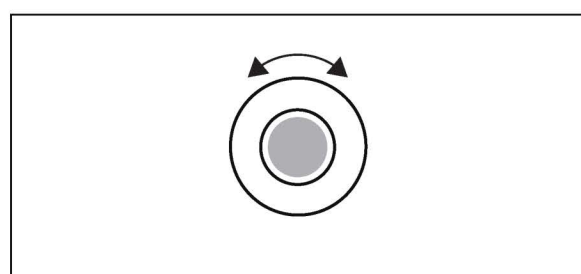

use the light gray knob to edit the destination parameter you wish to modulate with the pitchbend.

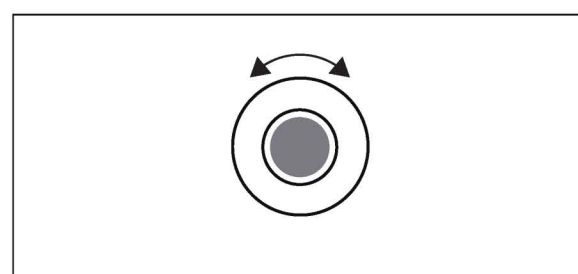

rotate the mid gray knob to select 'pitchbend amount'.

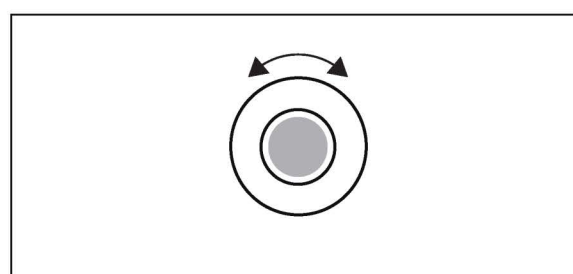

rotate the light gray knob to increase the amount the pitchbend will modulate the parameter. you can also set the modulation amount to a negative value to invert the modulation.

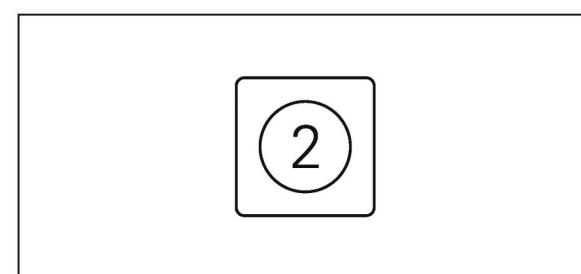

you'll notice that in some cases the pitchbend is still affecting pitch. lets fix that. press M2 to exit the preset settings and jump straight to the envelope module.

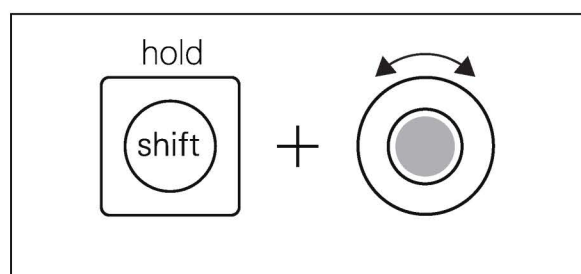

now hold shift and rotate the light gray knob anti-clockwise to set the pitchbend's pitch modulation to off.

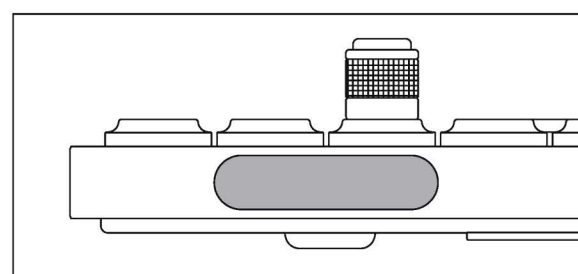

now your pitchbend will modulate only the selected parameter and not the pitch of your sound.

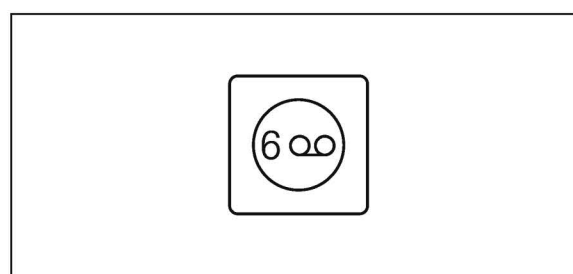

this will apply only to the instrument track you have set it up on, however you can apply the same idea to every instrument track, choosing a different parameter for each.

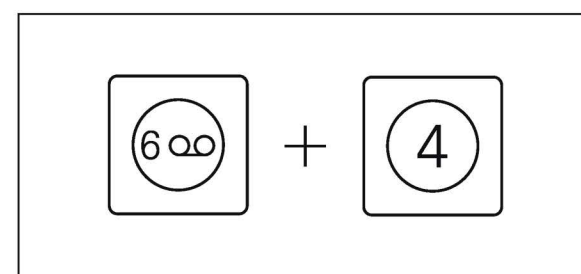

you can also save the current instrument track as a preset, this will not only save the synth engine and other parameters but also the preset settings, including the pitchbend settings.

22.10 how to backup your projects

while OP-XY can store thousands of projects, you may sometimes want to back them up or even start fresh. let's find out how.

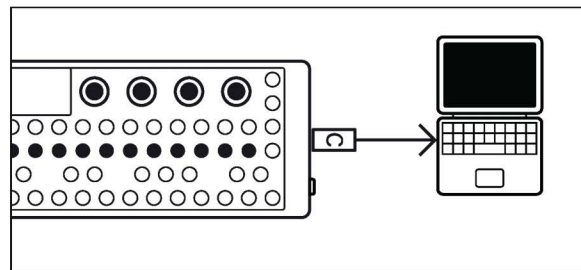

firstly, connect OP-XY to your computer with the included usb-c cable.

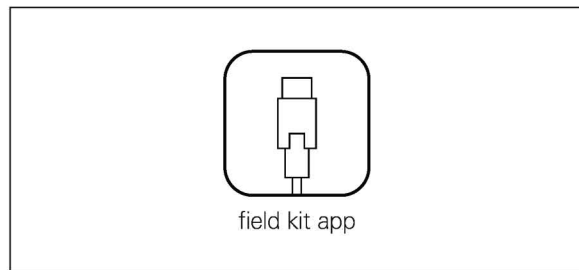

2. you will need the field-kit app if you are using a mac.

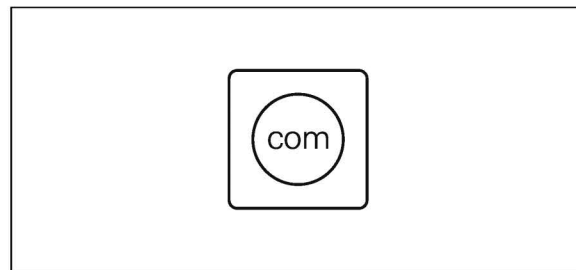

press com to enter com.

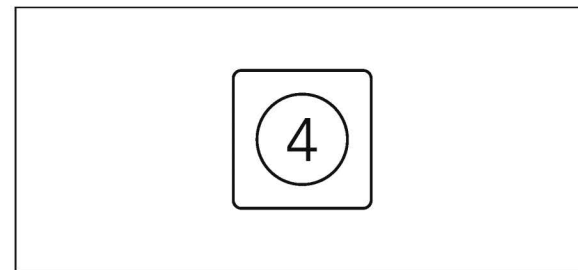

now press M4 to enter mtp mode. this will only become available when connected to a computer, so make sure to plug your OP-XY in first.

step-by-step guide

1. your OP-XY should now appear as a drive on your computer. if you are using a mac with field-kit and it does not automatically open, you can access the OP-XY's drive from field-kit on the task bar.

2. you should now see three folders: 'presets', 'projects' and 'samples'. open the projects folder, then the user folder within the projects folder.

3. you should now see a list with all of your projects, as well as a 'backups' folder.

4. the backups folder holds all of the history files for your projects.

5. to back one project up, you will need to copy both the project file and it's backup folder.

6. to backup all of your projects, select the whole project folder, copy it and then paste it somewhere safe.

7. should you wish to delete all the projects, you can do so by removing them from the projects folder.

8. you can also rename projects directly from your computer. just make sure to only use alphanumeric characters and the select special characters that are supported (-, # and space).

22.11 how to load samples from a computer into the sample folder on OP–XY

OP–XY can store thousands of samples in it's built-in 8gb drive. meaning you can load it up with all of your favourites and use them in your projects. let's learn how.

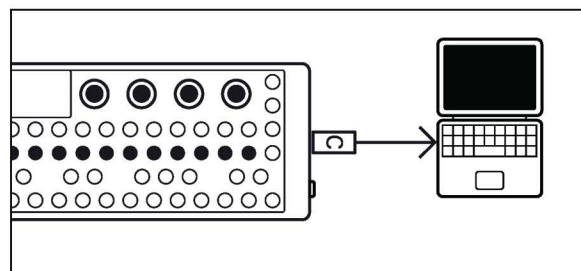

firstly, connect OP–XY to your computer with the included usb-c cable.

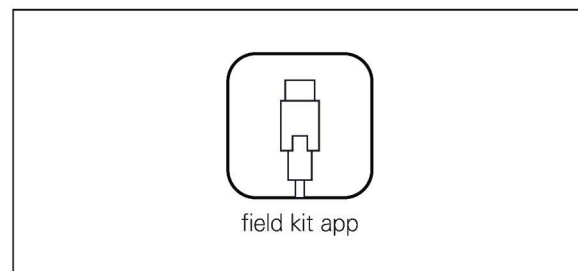

you will need the [field-kit app](#) if you are using a mac.

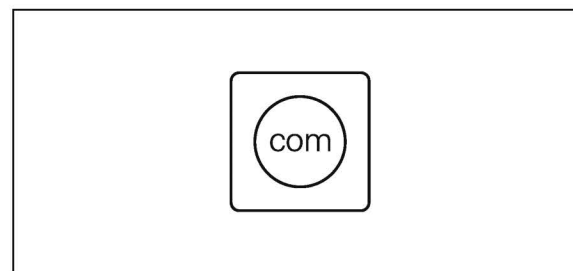

press com to enter com.

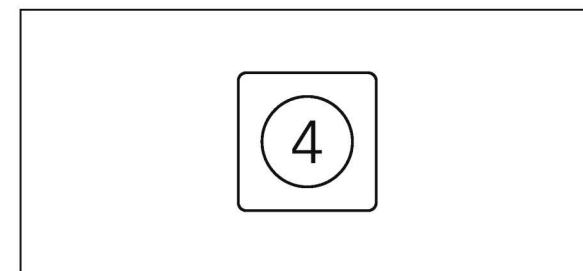

now press M4 to enter mtp mode. this will only become available when connected to a computer, so make sure to plug your OP–XY in first.

step-by-step guide

1. your OP–XY should now appear as a drive on your computer. if using a mac with field-kit and it does not automatically open the drive, you can access the OP–XY's drive from the field-kit drop down on the task bar.

2. you should now see three folders: 'presets', 'projects' and 'samples'. open the samples folder.

3. you should now see a folder named 'user', this is where samples will save to when you record them on OP–XY.

4. you can drag samples into the user folder, or create folders within the sample folder to hold and categorise your samples. OP–XY supports both aiff files and wav files.

5. its important to note that folders within those folders will not show on OP–XY. only if a folder has been created within the 'samples' folder will it show up.

6. OP–XY support wav files and aiff files, so make sure your samples are in the correct format. in addition, you may need to rename your samples, as only alphanumeric characters and some special characters are supported (-, # and space).

7. when you are done loading samples, simply eject OP–XY by pressing M4 then unplug the usb-c cable.

22.12 how to write a song fast, with the brain

the brain is one of the most powerful features within OP-XY, it can speed up your workflow substantially if used correctly, lets see how you can make the most of it.

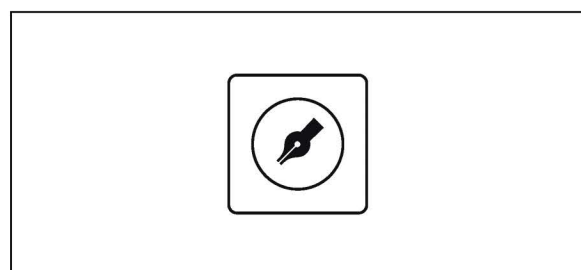

start by creating a new project.

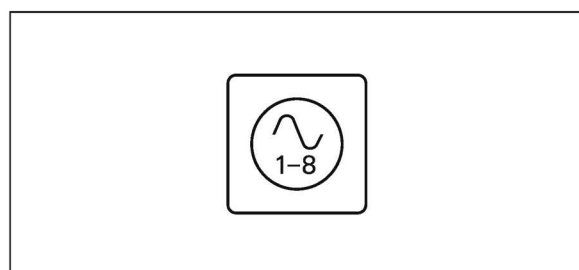

open the instrument mode and sequence a beat on a drum track.

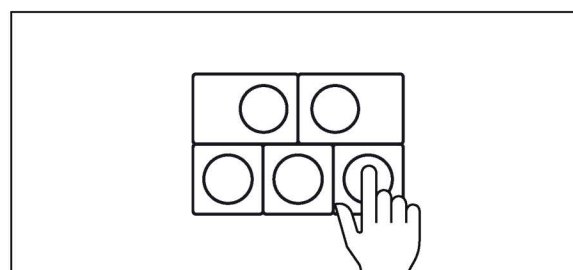

add a bassline, but only use one or two notes.

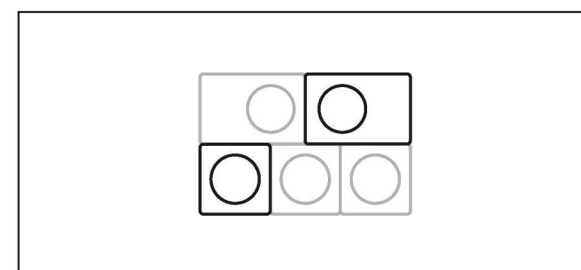

add one chord, sequenced as you like to a track with a pad or pluck. again making sure not to make anything too complex.

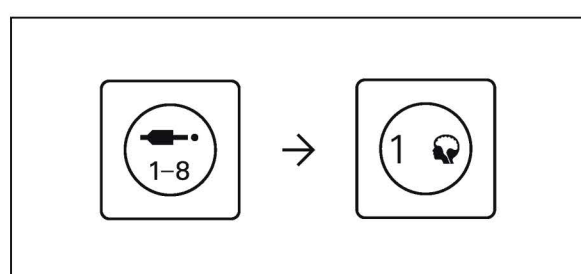

once you have a short one or two bar phrase that you are happy with press auxiliary to open the auxiliary mode and then select track 1 to open the brain.

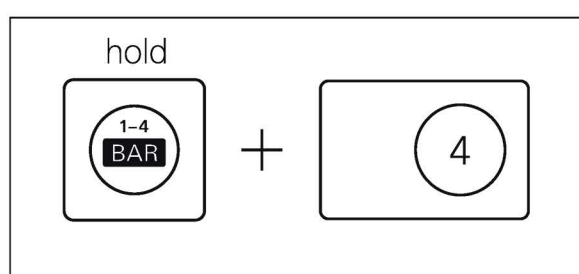

set the track scale to 4 by holding bar and pressing the accidental key labelled 4 (the c# key). this will play the pattern back 4 times slower, allowing you to sequence four bars in one sequence.

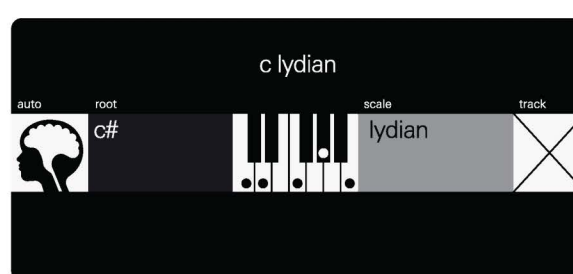

you'll notice in the brain that the key and scale of the notes recorded in the previous steps have been automatically detected. look at the scale and, while in brain, try playing some notes that fit within it. you will hear that as you play them the brain intelligently transposes the notes and chords.

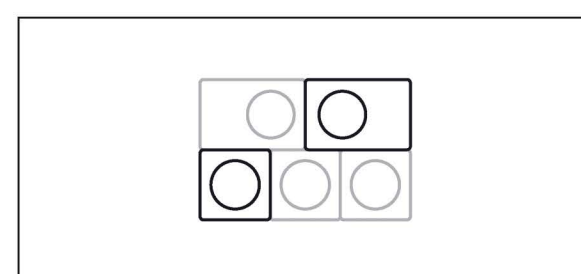

find a chord transition that you like by playing the musical keyboard while in the brain then record it into the step sequencer.

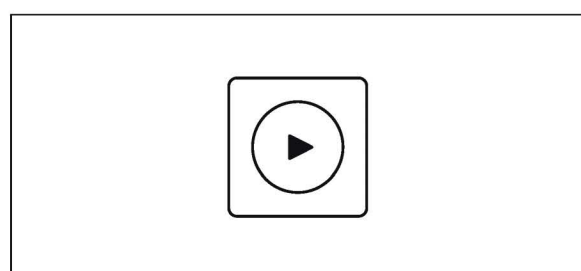

press play to hear your beat with the brain doing all the work for you.

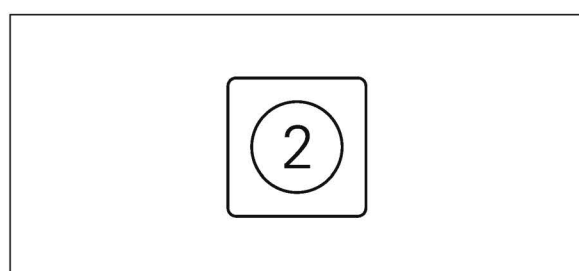

if you want to add a lead or any elements that don't get transposed, you can just remove them from the brain by going to it's routing by pressing M2 then turning the encoders to add or remove tracks, you can click them to switch between tracks 1-4 and 5-8.

23. midi cc reference table

sometimes you want to control OP–XY with an external controller. OP–XY has almost all of its controls pre-mapped as midi CCs. you can use this section to reference which CCs control which parameter.

parameter	cc	channel	range
track volume	7	1–16	0–127
track mute	9	1–16	0–127
track pan	10	1–16	0–127
track parameters	46	1–16	0–127
tempo	80	any	0–127
groove	81	any	0–127
scene	85	any	0–127
project	86	any	0–127
eq	90	1–4	0–127

24. te boot

te boot is where firmware updates, function tests and factory resets take place.

accessing te boot

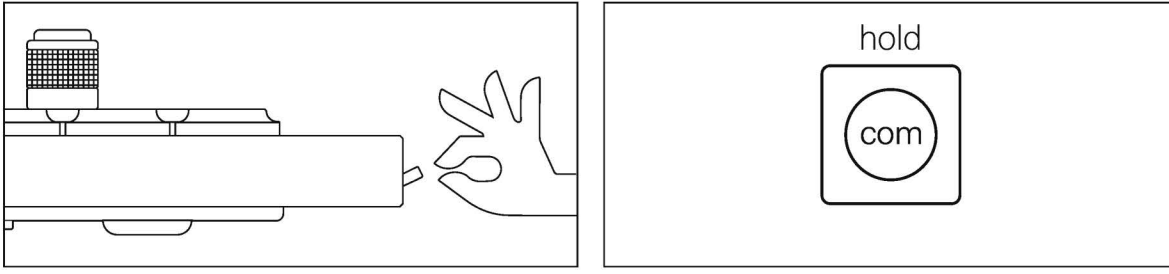

first power your OP-XY off. while powering on, hold com.

you will now be placed into te boot. the screen will show three options:

1. upload firmware
7. factory reset
8. system menu

24.1 firmware update

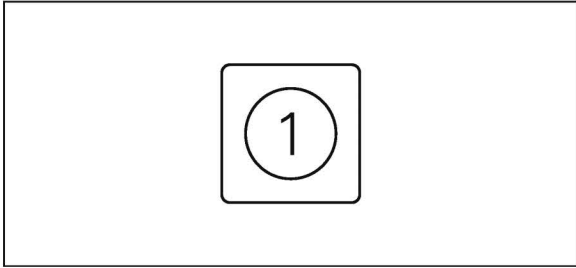

1. access te-boot
2. press track button 7
3. connect OP-XY to your computer with a usb cable. the OP-XY will appear as a removable disk on your cmoputer
4. copy the firmware file to the removable disk
5. eject the removable disk
6. the update will now start. wait for the update to finish and follow the on-screen instructions.

24.2 factory reset

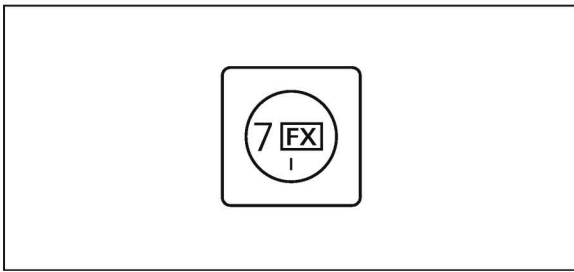

1. access te-boot
2. press track button 7
3. follow the on-screen instructions

note: all user content will be removed. if you wish to backup your data, you can do so by following the ["how to backup your projects"](#) chapter.

factory reset allows you to erase all user settings and content, as well as recreate the original file structure and restore the unit to factory default.

24.3 function test

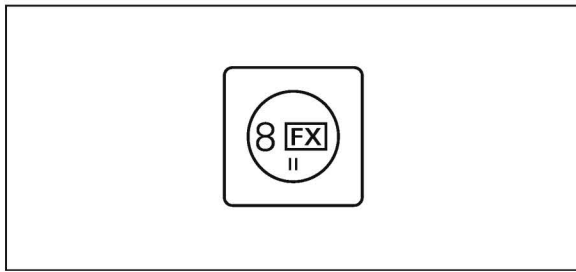

1. access te-boot
2. press track button 8
3. follow the on-screen instructions

note: if you press any buttons and they still show up red then please contact our customer support.

24.4 reset volume potentiometer calibration



1. access te-boot
2. press track button 8
3. follow the on-screen instructions

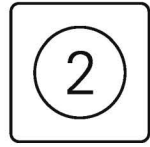

press the M2 or track 2 button to select "reset volume pot calibration". when done you will be taken back to te boot.

24.5 exiting te boot

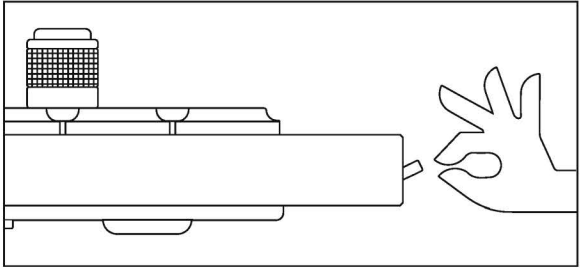

if you wish to exit te boot,
simply power your device
off and then on again.

25. credits

our special thanks go to the following individuals.

testers

5starnomad
alvaro villalobos
cuckoo
dimi3
matt donald
mathew williams
michael hellqvist
sean hellfritsch
nick martin
pierre blanc
tom lagerman
virtual flannel

content

alexi delano
benjamin mull
cengiz
christian olsson
daito manabe
nosaj thing
rephazer <<https://www.rephazer.com>>
red pipe studios
samples from mars
the phonoloop

